

5120823-1 ✓ ACTIVE

Z-PACK | Z-PACK 2mm HM

TE Internal #: 5120823-1

Z-PACK 2mm HM, Hard Metric Backplane Connectors, PCB Mount

Header, ≤1 Gb/s, 12 Column, 12 Row, Board-to-Board, 144

Position, 2mm Centerline, Vertical

[View on TE.com >](#)



Connectors > PCB Connectors > Backplane Connectors > Hard Metric Connectors

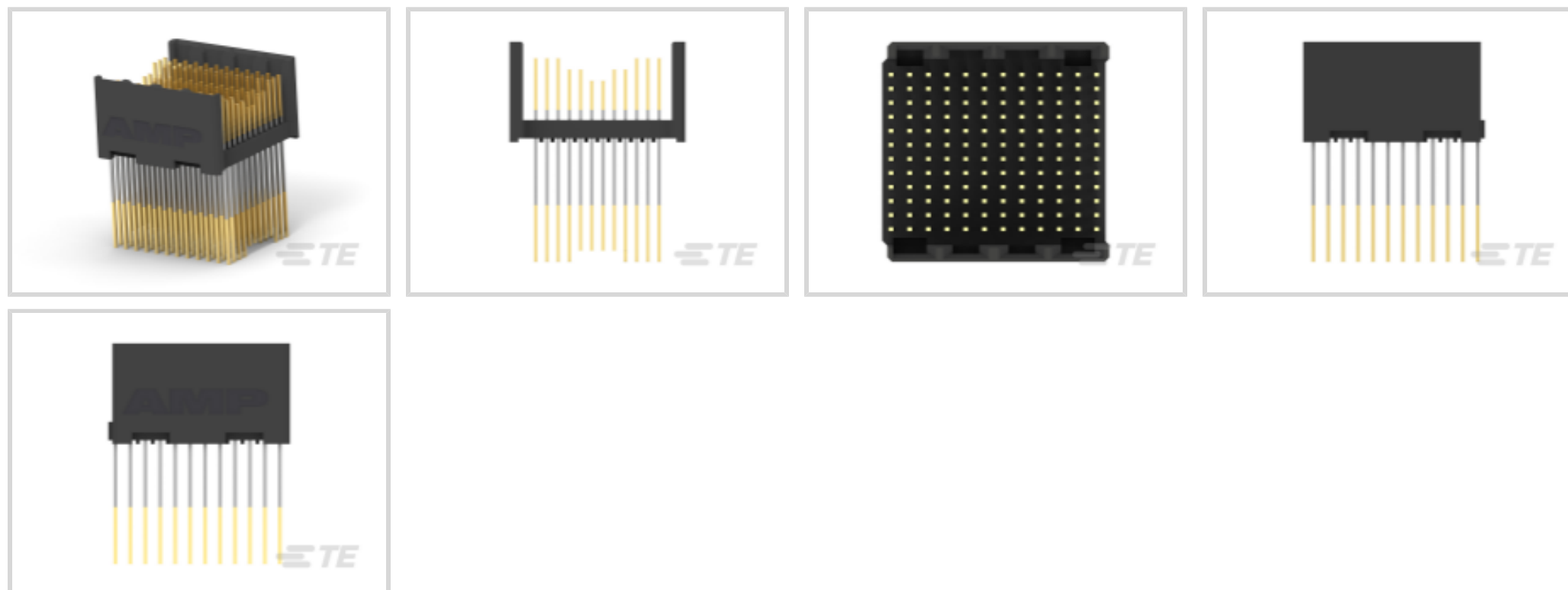

PCB Connector Assembly Type: **PCB Mount Header**

Data Rate: **≤1 Gb/s**

Number of Columns: **12**

Number of Rows: **12**

Connector System: **Board-to-Board**

Features

Product Type Features

PCB Connector Assembly Type	PCB Mount Header
Connector System	Board-to-Board
Sealable	No
Connector & Contact Terminates To	Printed Circuit Board

Configuration Features

Number of Columns	12
Number of Rows	12
Number of Positions	144
PCB Mount Orientation	Vertical

Signal Characteristics

Data Rate	≤1 Gb/s
-----------	---------

Contact Features

CompactPCI Designation	None
Contact Mating Area Plating Material	Gold



Contact Current Rating (Max)	1.5 A
------------------------------	-------

Mechanical Attachment

Connector Mounting Type	Board Mount
-------------------------	-------------

Housing Features

Centerline (Pitch)	2 mm
--------------------	------

Housing Color	Gray
---------------	------

Usage Conditions

Operating Temperature Range	-55 – 125 °C
-----------------------------	--------------

Operation/Application

Circuit Application	Power & Signal
---------------------	----------------

Industry Standards

AdvancedTCA Specified Product	No
-------------------------------	----

Packaging Features

Packaging Method	Tube
------------------	------

Product Compliance

[For compliance documentation, visit the product page on TE.com>](#)

EU RoHS Directive 2011/65/EU	Compliant
------------------------------	-----------

EU ELV Directive 2000/53/EC	Compliant
-----------------------------	-----------

China RoHS 2 Directive MIIT Order No 32, 2016	No Restricted Materials Above Threshold
---	---

EU REACH Regulation (EC) No. 1907/2006	Current ECHA Candidate List: JUN 2020 (209) Candidate List Declared Against: JAN 2019 (197) Does not contain REACH SVHC
--	---

Halogen Content	Not Low Halogen - contains Br or Cl > 900 ppm.
-----------------	--

Solder Process Capability	Not applicable for solder process capability
---------------------------	--

Product Compliance Disclaimer

This information is provided based on reasonable inquiry of our suppliers and represents our current actual knowledge based on the information they provided. This information is subject to change. The part numbers that TE has identified as EU RoHS compliant have a maximum concentration of 0.1% by weight in homogenous materials for lead, hexavalent chromium, mercury, PBB, PBDE, DBP, BBP, DEHP, DIBP, and 0.01% for cadmium, or qualify for an exemption to these limits as defined in the Annexes of Directive 2011/65/EU (RoHS2). Finished electrical and electronic equipment products will be CE marked as required by Directive 2011/65/EU. Components may not be CE marked. Additionally, the part numbers that TE has identified as EU ELV compliant have a maximum concentration of 0.1% by weight in homogenous materials for lead, hexavalent chromium, and mercury, and 0.01% for cadmium, or qualify for an exemption to these limits

as defined in the Annexes of Directive 2000/53/EC (ELV). Regarding the REACH Regulation, the information TE provides on SVHC in articles for this part number is based on the latest European Chemicals Agency (ECHA) 'Guidance on requirements for substances in articles' posted at this URL: <https://echa.europa.eu/guidance-documents/guidance-on-reach>

Compatible Parts



Also in the Series | Z-PACK 2mm HM

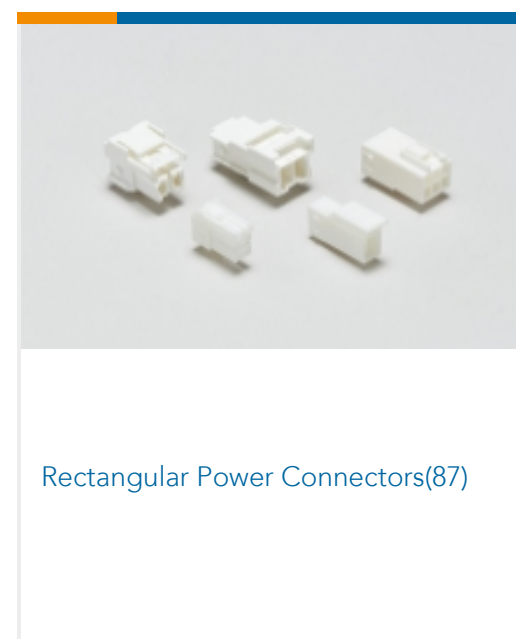
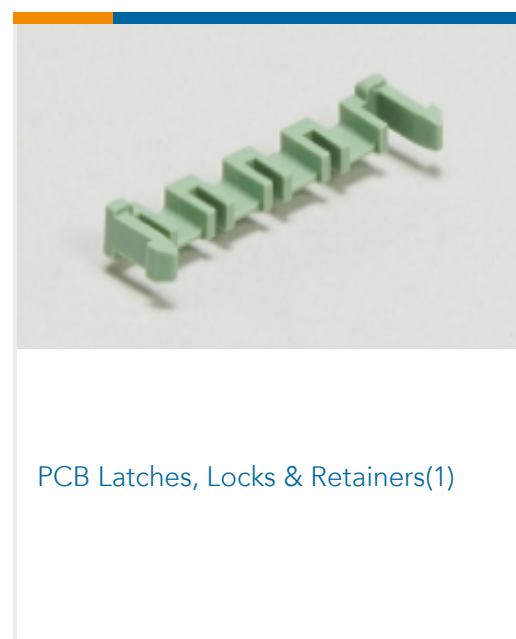
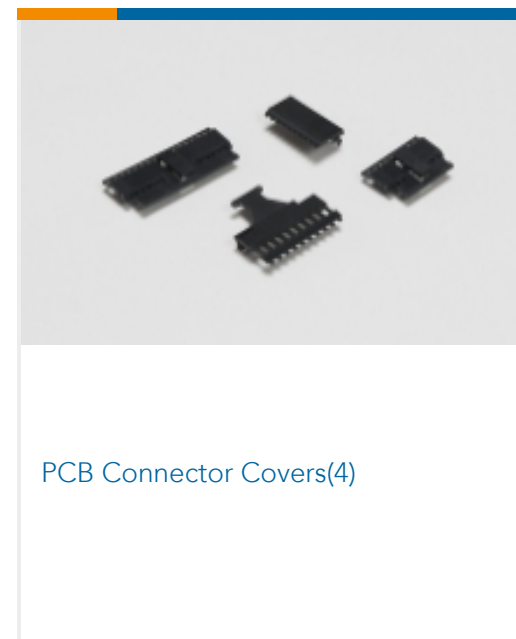
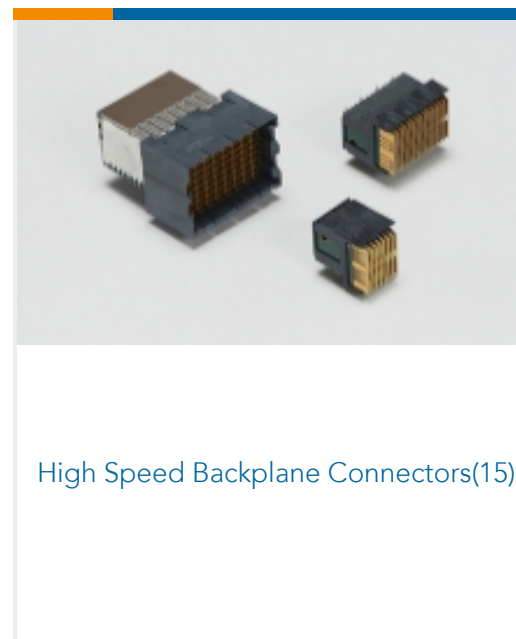
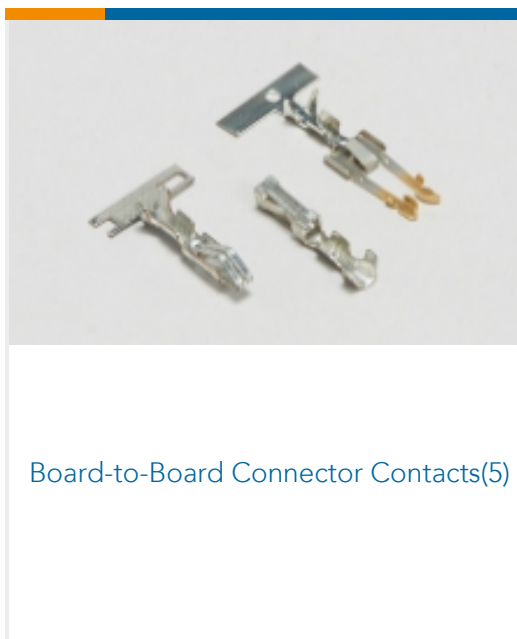
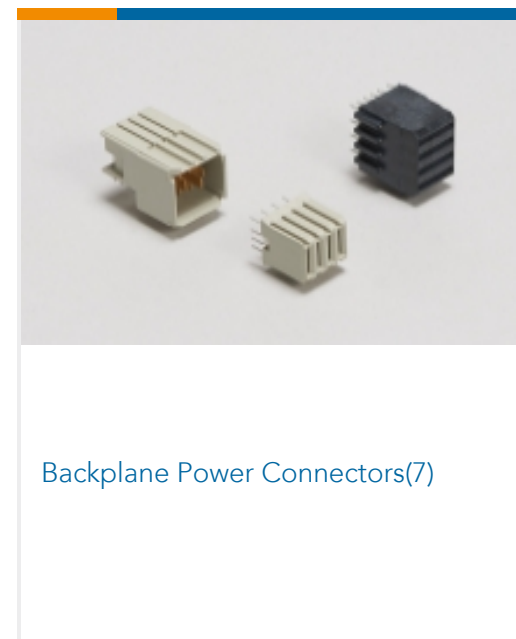
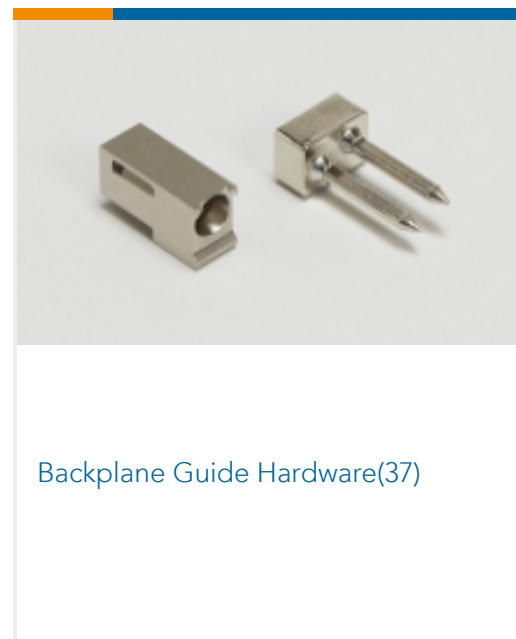
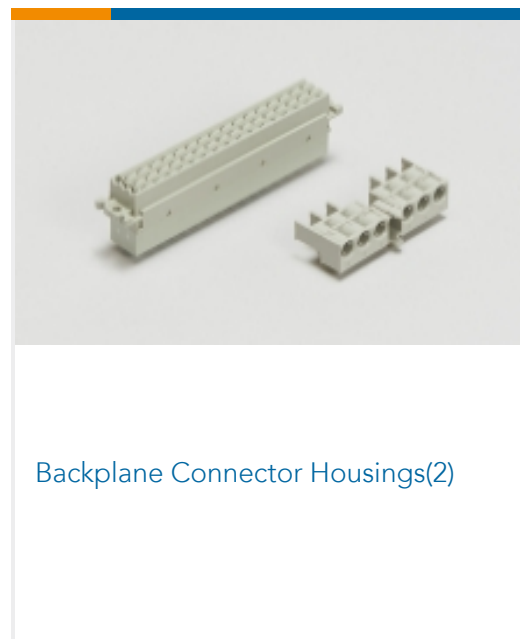
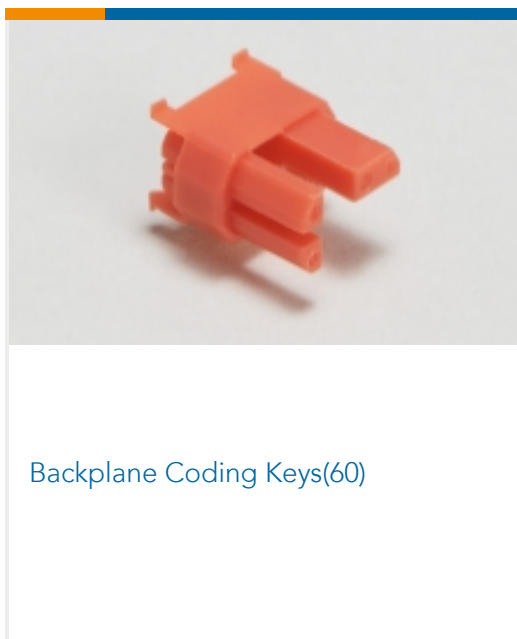

Customers Also Bought

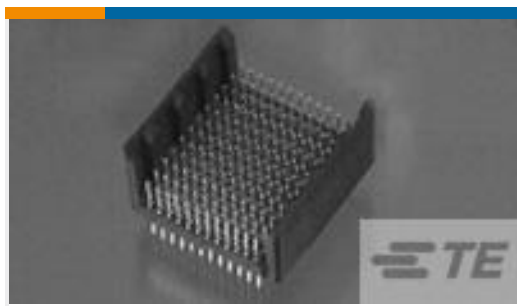

TE Model / Part #5120779-1
2MMHM HDR ASY, 12R SEL/LD 144 P



TE Model / Part #5-103233-8
18 MODII HDR DRST UNSHRD A/PIN



TE Model / Part #120647-3
2MM HM SHR/HSG RH 072P 3.00 H

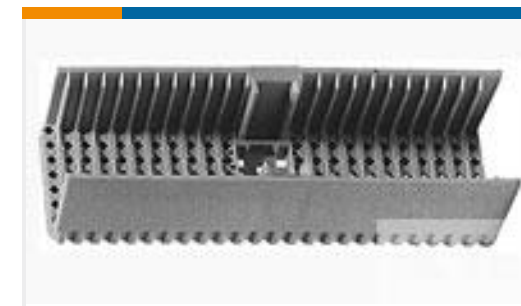

TE Model / Part #120648-3
2MM HM SHR/HSG LH 072 3.00 H

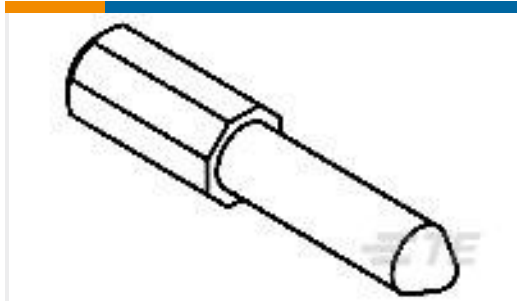

TE Model / Part #120759-2
Z-PACK GUIDE PIN FEED THRU PLT

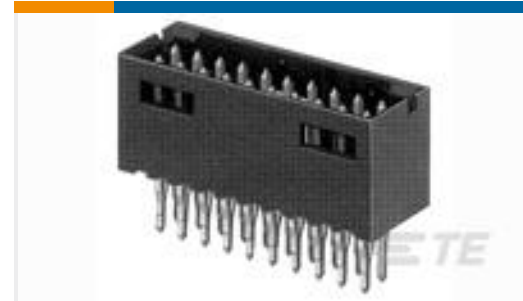

TE Model / Part #5-102557-2
20 MODII HDR DRST SHRD A/PIN

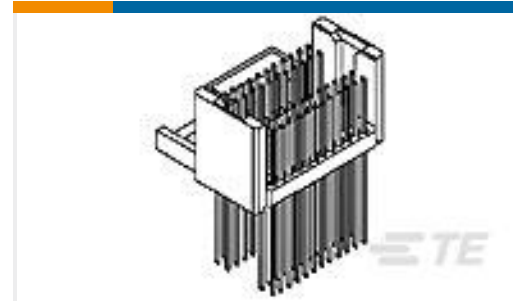

TE Model / Part #5120824-1
2MMHM HDR ASY, 12R SEL/LD 72P L

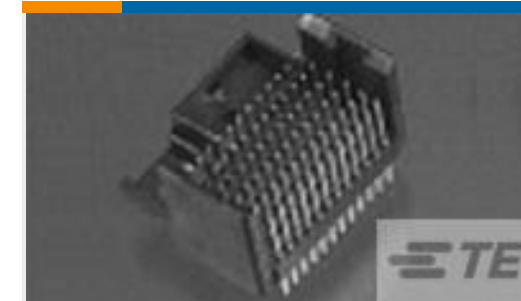

TE Model / Part #5120825-1
2MMHM HDR ASY, 12R SEL/LD 72P R



TE Model / Part #120645-3
2MM HM SHROUD HSG 144P 3.00 H



TE Model / Part #5536096-5
ASSY, PIN, EUROCARD, TYPE R, LEAD-FREE, 150PO

Documents

Product Drawings

[2MMHM HDR ASY, 12R SEL/LD 144P](#)

English

CAD Files

[3D PDF](#)

3D

Customer View Model

[ENG_CVM_CVM_5120823-1_A.2d_dxf.zip](#)

English

Customer View Model

[ENG_CVM_CVM_5120823-1_A.3d_igs.zip](#)

English

Customer View Model

[ENG_CVM_CVM_5120823-1_A.3d_stp.zip](#)

English

By downloading the CAD file I accept and agree to the [Terms and Conditions](#) of use.

Product Specifications



Application Specification

English