

PLEASE CHECK WWW.MOLEX.COM FOR LATEST PART INFORMATION

Part Number: [51048-0800](#)
Status: **Active**
Description: 2.00mm Pitch Cable Holder, Vertical, Low Profile, for Ribbon Cable, 8 Circuits

Documents:

[3D Model](#) [RoHS Certificate of Compliance \(PDF\)](#)
[Drawing \(PDF\)](#)

General

Product Family	Ribbon Cable / Wire Trap Connectors
Series	51048
Component Type	One Piece
Glow-Wire Compliant	No
Product Name	Board-In, Cable Holder
UPC	800753750883

Physical

Circuits (Loaded)	8
Color - Resin	Natural
Entry Angle	Vertical
Lock to Mating Part	None
Material - Plating Mating	N/A
Material - Resin	Nylon
Net Weight	177.900/mg
Number of Rows	1
PCB Retention	Yes
PCB Thickness - Recommended	1.60mm
Packaging Type	Bag
Pitch - Mating Interface	2.00mm
Pitch - Termination Interface	2.00mm
Polarized to Mating Part	N/A
Polarized to PCB	No
Stackable	No
Surface Mount Compatible (SMC)	No
Temperature Range - Operating	-40°C to +105°C
Wire Insulation Diameter	1.60mm max.
Wire Size AWG	26
Wire/Cable Type	Ribbon Cable

Electrical

Current - Maximum per Contact	N/A
Voltage - Maximum	N/A

Material Info

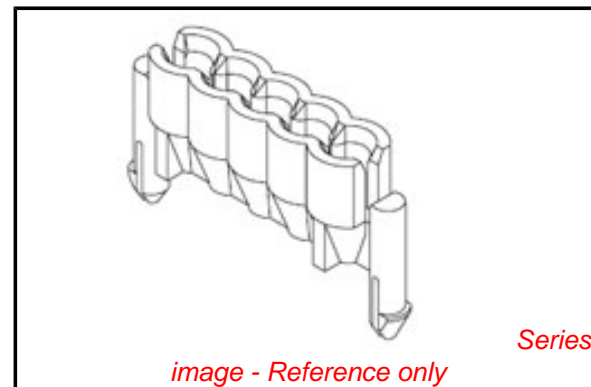

EU RoHS

ELV and RoHS Compliant
REACH SVHC Contains SVHC: No
Low-Halogen Status Low-Halogen

China RoHS



Need more information on product environmental compliance?

Email productcompliance@molex.com
 For a multiple part number RoHS Certificate of Compliance, [click here](#)

Please visit the [Contact Us](#) section for any non-product compliance questions.

Search Parts in this Series

51048Series

Mates With

N/A

Use With

Topcoated Ribbon Cable