

5100785-9 ✓ ACTIVE

Z-PACK | Z-PACK 2mm HM

TE Internal #: 5100785-9

Hard Metric Backplane Connectors, PCB Mount Header, ≤ 1 Gb/s,
25 Column, 5 Row, Mezzanine, 125 Position, 2 mm [.078 in]

Centerline, Z-PACK 2mm HM

[View on TE.com >](#)



[Connectors >](#) [PCB Connectors >](#) [Backplane Connectors >](#) [Hard Metric Backplane Connectors >](#)

Hard Metric Male Connector: Traditional Backplane, Mezzanine, 2mm



PCB Connector Assembly Type: **PCB Mount Header**

Data Rate: ≤ 1 Gb/s

Number of Columns: **25**

Number of Rows: **5**

Backplane Architecture: **Mezzanine**

[All Hard Metric Male Connector: Traditional Backplane, Mezzanine, 2mm \(124\)](#)

Features

Product Type Features

Backplane Interface Type	2mm HM
PCB Connector Assembly Type	PCB Mount Header
Connector System	Board-to-Board
Sealable	No
Connector & Contact Terminates To	Printed Circuit Board

Configuration Features

Number of Columns	25
Number of Rows	5
Backplane Architecture	Mezzanine
Number of Positions	125
PCB Mount Orientation	Vertical

Signal Characteristics

Data Rate	≤ 1 Gb/s
-----------	---------------

Body Features

Primary Product Color	Gray
-----------------------	------

Contact Features



Feedthrough Post Length	3.7 mm
CompactPCI Designation	None
Contact Type	Pin
Contact Underplating Material	Nickel
PCB Contact Termination Area Plating Material	Tin
Contact Base Material	Phosphor Bronze
Contact Mating Area Plating Material	Gold
Contact Mating Area Plating Material Thickness	.76 μm[30 μin]
Contact Current Rating (Max)	1.5 A

Termination Features

Termination Method to Printed Circuit Board	Through Hole - Press-Fit
---	--------------------------

Mechanical Attachment

Connector Mounting Type	Board Mount
-------------------------	-------------

Housing Features

Housing Material	Polyester - GF
Centerline (Pitch)	2 mm[.078 in]

Dimensions

Backplane Module Length	49.88 mm
-------------------------	----------

Usage Conditions

Operating Temperature Range	-55 – 125 °C[-67 – 257 °F]
-----------------------------	----------------------------

Operation/Application

Shielded	No
Circuit Application	Power & Signal

Industry Standards

UL Flammability Rating	UL 94V-0
------------------------	----------

Packaging Features

Packaging Quantity	10
Packaging Method	Tube

Product Compliance

[For compliance documentation, visit the product page on TE.com>](#)



EU RoHS Directive 2011/65/EU	Compliant
EU ELV Directive 2000/53/EC	Compliant
China RoHS 2 Directive MIIT Order No 32, 2016	No Restricted Materials Above Threshold
EU REACH Regulation (EC) No. 1907/2006	Current ECHA Candidate List: JUNE 2023 (235) Candidate List Declared Against: JUNE 2023 (235) Does not contain REACH SVHC
Halogen Content	Not Low Halogen - contains Br or Cl > 900 ppm.
Solder Process Capability	Not applicable for solder process capability

Product Compliance Disclaimer

This information is provided based on reasonable inquiry of our suppliers and represents our current actual knowledge based on the information they provided. This information is subject to change. The part numbers that TE has identified as EU RoHS compliant have a maximum concentration of 0.1% by weight in homogenous materials for lead, hexavalent chromium, mercury, PBB, PBDE, DBP, BBP, DEHP, DIBP, and 0.01% for cadmium, or qualify for an exemption to these limits as defined in the Annexes of Directive 2011/65/EU (RoHS2). Finished electrical and electronic equipment products will be CE marked as required by Directive 2011/65/EU. Components may not be CE marked. Additionally, the part numbers that TE has identified as EU ELV compliant have a maximum concentration of 0.1% by weight in homogenous materials for lead, hexavalent chromium, and mercury, and 0.01% for cadmium, or qualify for an exemption to these limits as defined in the Annexes of Directive 2000/53/EC (ELV). Regarding the REACH Regulation, the information TE provides on SVHC in articles for this part number is based on the latest European Chemicals Agency (ECHA) 'Guidance on requirements for substances in articles' posted at this URL: <https://echa.europa.eu/guidance-documents/guidance-on-reach>

Compatible Parts

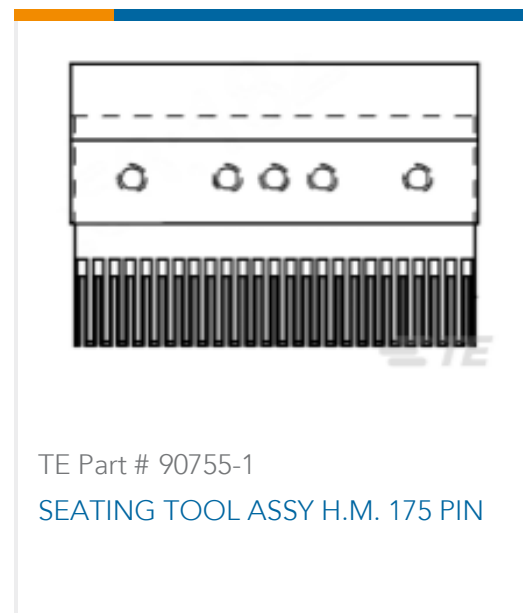

Also in the Series | Z-PACK 2mm HM

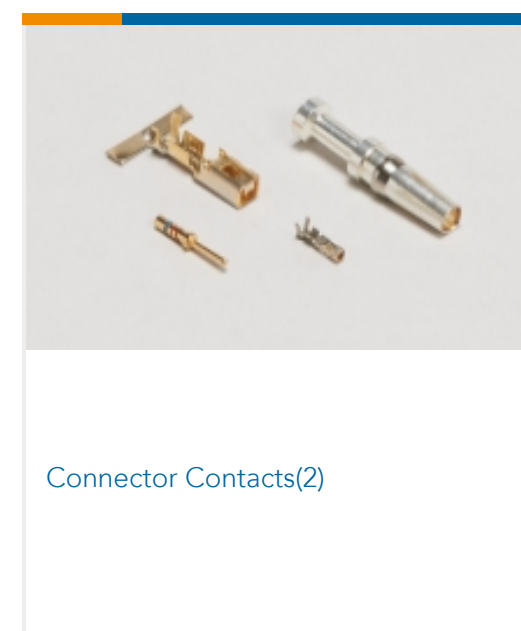
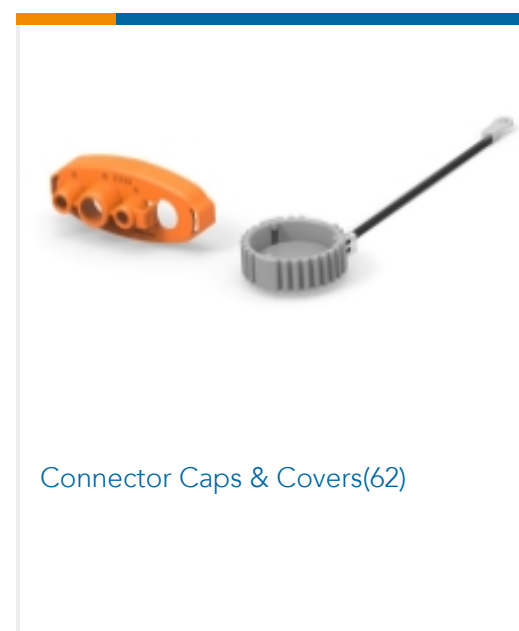
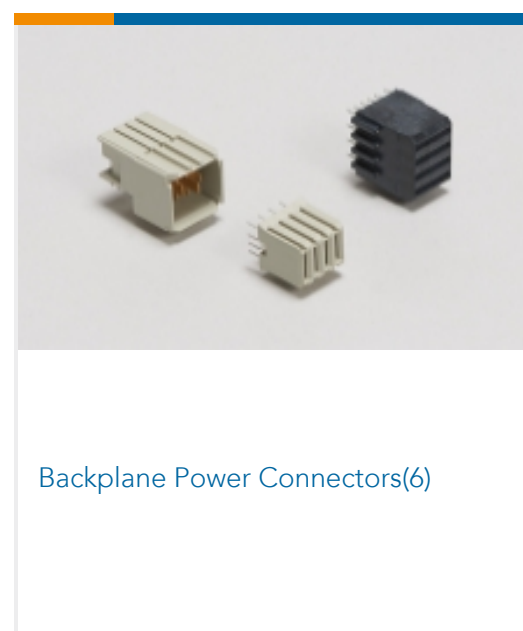
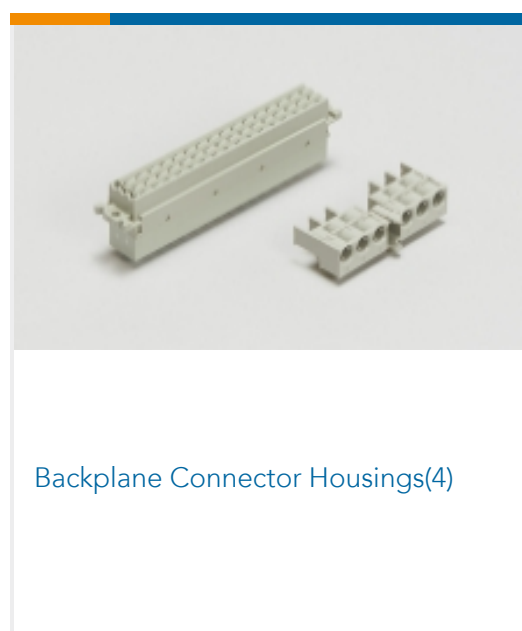



Connector Hardware(97)

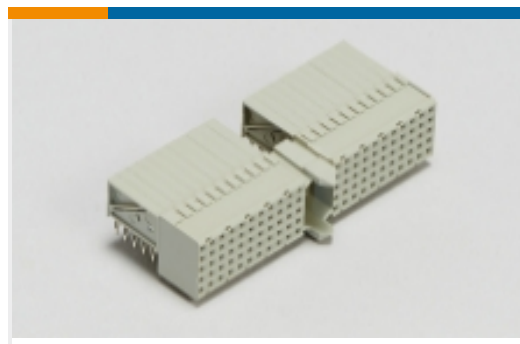

Hard Metric Backplane Connectors (267)

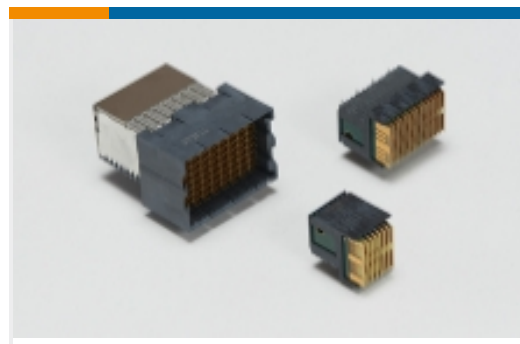

High Speed Backplane Connectors(1)

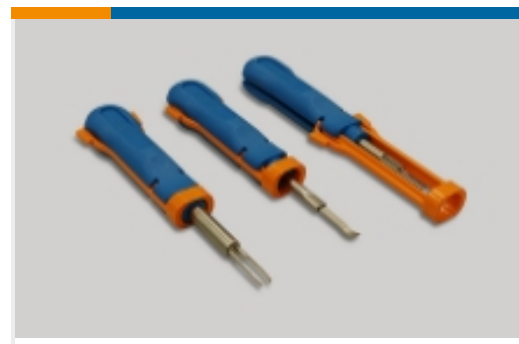

Insertion & Extraction Tools(2)



Rectangular Power Connectors(87)

Customers Also Bought



TE Part #5053304040
RNF-100-1-RD-SP



TE Part #D11555-000
NT-MIL-2-0-SP



TE Part #50864-6
SOCKET,MIN-SPR SN SER-3

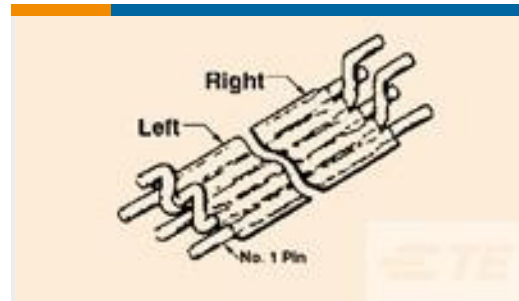

TE Part #6437132-4
FSN-12D-20



TE Part #1544162-2
CONTACTS A SOUDER



TE Part #1-1825043-3
UP3DTAOLA04,MICROSWITCH,SNAP

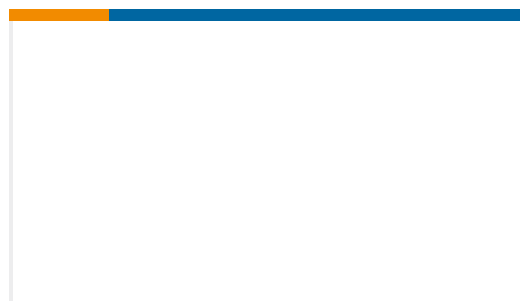

TE Part #173630-7

Documents

Product Drawings

Z-PACK/B M-HDR 125P

English

CAD Files

3D PDF

3D

Customer View Model

ENG_CVM_CVM_5100785-9_B.2d_dxf.zip



English

Customer View Model

[ENG_CVM_CVM_5100785-9_B.3d_igs.zip](#)

English

Customer View Model

[ENG_CVM_CVM_5100785-9_B.3d_stp.zip](#)

English

By downloading the CAD file I accept and agree to the [Terms and Conditions](#) of use.

Product Specifications

[Application Specification](#)

English