

CGPT-9.5/4.8-6-SP ✓ ACTIVE

RAYCHEM | RAYCHEM CGPT

TE Internal #: 5068324006

Blue, 2:1, Single Wall Tubing, Shrinks To .187 in [4.8 mm], Irradiated Modified Polyolefin, .375 in [9.5 mm] Inner Diameter, RAYCHEM CGPT

[View on TE.com >](#)



Heat Shrink Tubing



Primary Product Color: **Blue**

Wall Type: **Single Wall**

Expanded Inside Diameter (Min): **9.5 mm [.375 in]**

Recovered Inside Diameter (Max): **4.8 mm [.187 in]**

Shrink Ratio: **2:1**

Features

Product Type Features

Wall Type	Single Wall
-----------	-------------

Electrical Characteristics

Operating Voltage (Max)	.6 kV
-------------------------	-------

Body Features

Fluid Type	Gasoline, Hydraulic Fluid, Lubricating Oil
Primary Product Color	Blue
Shrink Ratio	2:1
Primary Product Material	Irradiated Modified Polyolefin
Flexibility	Flexible

Dimensions

Recovered Wall Thickness (Tolerance)	.15 mm[.006 in]
Recovered Wall Thickness (Nominal)	.65 mm[.026 in]
Expanded Inside Diameter (Min)	9.5 mm[.375 in]
Recovered Inside Diameter (Max)	4.8 mm[.187 in]
Tubing Size Range	4.8 – 9.5 mm[.187 – .375 in]

Usage Conditions

Shrink Temperature (Min)	80 °C
--------------------------	-------



Tubing Flammability Type	Flame-Retardant
--------------------------	-----------------

Operating Temperature Range	-40 – 135 °C
-----------------------------	--------------

Recovery Temperature	120 °C
----------------------	--------

Operation/Application

Mechanical Resistance	Fluids, Mechanical Damage, Strain Relief
-----------------------	--

Product Availability

Applicable Region	Asia, EMEA
-------------------	------------

Packaging Features

Packaging Method	Box
------------------	-----

Other

Meets Low Outgassing Requirements	No
-----------------------------------	----

Product Source	Czech Republic
----------------	----------------

Product Compliance

[For compliance documentation, visit the product page on TE.com>](#)

EU RoHS Directive 2011/65/EU	Compliant
------------------------------	-----------

EU ELV Directive 2000/53/EC	Compliant
-----------------------------	-----------

China RoHS 2 Directive MIIT Order No 32, 2016	No Restricted Materials Above Threshold
---	---

EU REACH Regulation (EC) No. 1907/2006	Current ECHA Candidate List: JUNE 2023 (235) Candidate List Declared Against: JUNE 2023 (235) Does not contain REACH SVHC
--	---

Halogen Content	Not Low Halogen - contains Br or Cl > 900 ppm.
-----------------	--

Solder Process Capability	Not applicable for solder process capability
---------------------------	--

Product Compliance Disclaimer

This information is provided based on reasonable inquiry of our suppliers and represents our current actual knowledge based on the information they provided. This information is subject to change. The part numbers that TE has identified as EU RoHS compliant have a maximum concentration of 0.1% by weight in homogenous materials for lead, hexavalent chromium, mercury, PBB, PBDE, DBP, BBP, DEHP, DIBP, and 0.01% for cadmium, or qualify for an exemption to these limits as defined in the Annexes of Directive 2011/65/EU (RoHS2). Finished electrical and electronic equipment products will be CE marked as required by Directive 2011/65/EU. Components may not be CE marked. Additionally, the part numbers that TE has identified as EU ELV compliant have a maximum concentration of 0.1% by weight in homogenous materials for lead, hexavalent chromium, and mercury, and 0.01% for cadmium, or qualify for an exemption to these limits as defined in the Annexes of Directive 2000/53/EC (ELV). Regarding the REACH Regulation, the information TE provides on SVHC in articles for this part number is based on the latest European Chemicals Agency (ECHA) 'Guidance on requirements for substances in articles' posted at this URL: <https://echa.europa.eu/guidance-documents/guidance-on-reach>



Compatible Parts



TE Part # EG1114-000
CV1981-ST-230V1600W-EU

Also in the Series | RAYCHEM CGPT

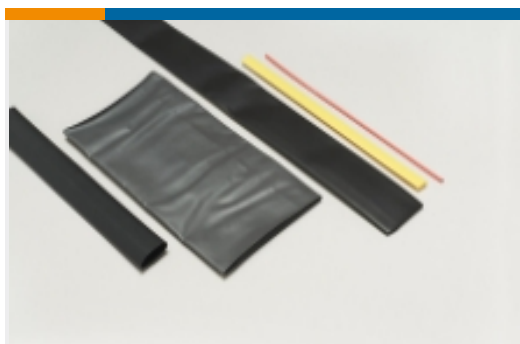

Heat Shrink Tubing(342)



Power Cable Tubing & Accessories(93)

Customers Also Bought



TE Part #182734-2
CONTACT REC HE14 COSI LOOSE P

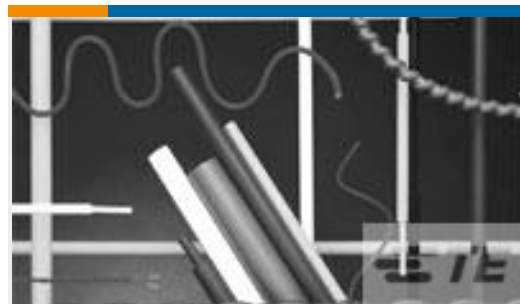

TE Part #5069894005
CGPT-38/19-0-SP

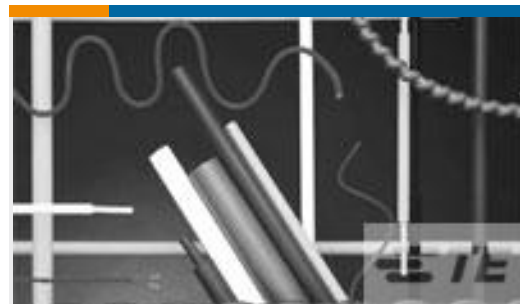

TE Part #5069724010
CGPT-6.4/3.2-X-SP

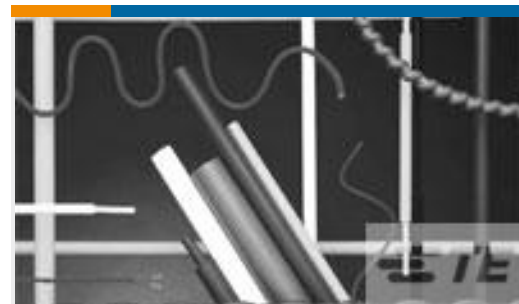

TE Part #5069734006
CGPT-9.5/4.8-X-SP

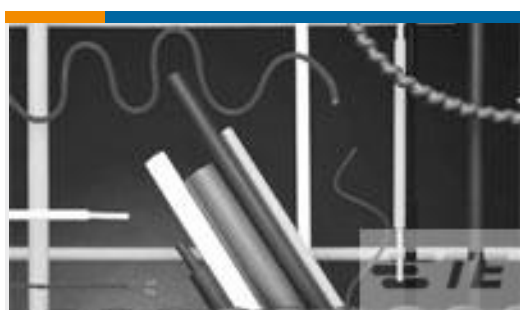

TE Part #5069854021
CGPT-9.5/4.8-0-SP

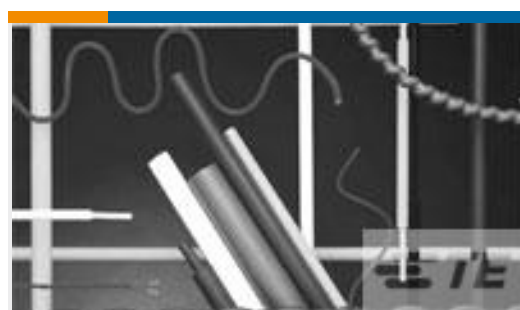

TE Part #5069844021
CGPT-6.4/3.2-0-SP

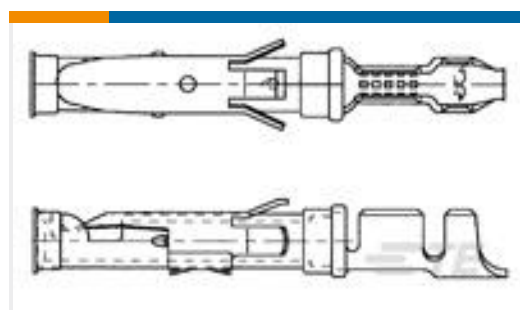

TE Part #163087-8
062 SOC.ASS. TYP3+

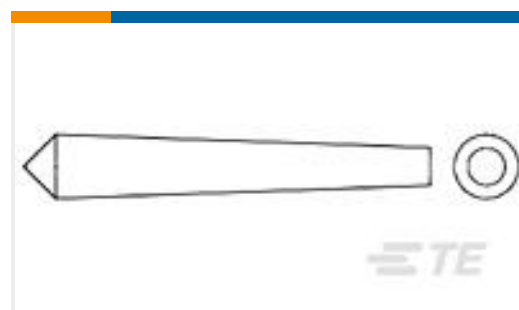

TE Part #770678-1
SEAL PLUG, AMPSEAL

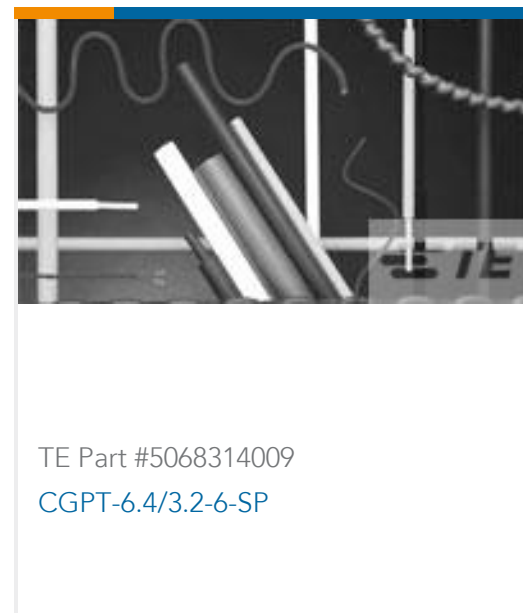

Documents

Product Drawings

[CGPT-9.5/4.8-6-SP](#)

English

Datasheets & Catalog Pages

[CGPT Pages from 9-1773447-9](#)

English

Product Specifications

[Quality Specification](#)

English