

PLEASE CHECK WWW.MOLEX.COM FOR LATEST PART INFORMATION

Part Number: [5037761620](#)
Status: **Active**
Overview: SlimStack Board-to-Board Connectors
Description: SlimStack Board-to-Board Connector, 0.40mm Pitch, B8 Series, Plug, 0.80mm Mated Height, 2.50mm Mated Width, 16 Circuits

Documents:

3D Model	Packaging Specification 5037769200-200 (PDF)
Drawing (PDF)	RoHS Certificate of Compliance (PDF)
Product Specification PS-503772-001-001 (PDF)	Product Literature (PDF)
Product Specification PS-503772-002-001 (PDF)	Product Literature (PDF)
Application Specification AS-503772-001-001 (PDF)	

General

Product Family	PCB Headers
Series	503776
3D Viewer	Yes
Application	Board-to-Board, Signal
CURRENT-MAX-NUMERIC	0.3
Datasheet Order No	987650-6531, 987650-6532_JA, 987650-6533_KO, 987650-6534_ZH, 987650-6536_DE, 987650-6537_ES
Overview	SlimStack Board-to-Board Connectors
PITCH-MATING-NUMERIC	0.40
Product Guide Order No	987651-8281
Product Literature Order No	987652-0196, Reference Guide#
Product Name	SlimStack
Series Name	B8
UPC	889056921336

Physical

Breakaway	No
Circuits (Loaded)	16
Circuits (maximum)	16
Color - Resin	Black
Durability (mating cycles max)	30
Glow-Wire Capable	No
Lock to Mating Part	Yes
Mated Height	0.80mm
Mated Width	2.50mm
Material - Metal	Copper Alloy
Material - Plating Mating	Gold
Material - Plating Termination	Gold
Net Weight	8.600/mg
Number of Rows	2
Orientation	Vertical
PCB Locator	No
PCB Retention	Yes
Packaging Type	Embossed Tape on Reel
Pitch - Mating Interface	0.40mm
Polarized to Mating Part	No
Polarized to PCB	No
Temperature Range - Operating	-40° to +85°C
Termination Interface: Style	Surface Mount

Electrical

Current - Maximum per Contact	0.3A
Voltage - Maximum	50V AC/DC

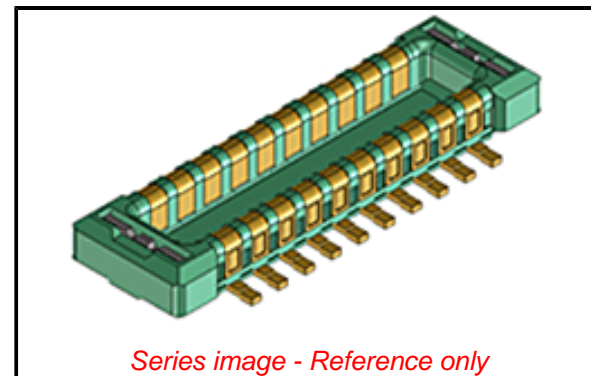

EU ELV

Not Relevant

EU RoHS

Compliant

REACH SVHC

Not Contained Per - ED/71/2019 (16 July 2019)

Halogen-Free

Status

Low-Halogen

For more information, please visit [Contact US](#)

China ROHS

ELV

RoHS Phthalates

China RoHS

Green Image

Not Relevant

Not Contained

Search Parts in this Series

[503776](#) Series

Mates With

SlimStack B8 Receptacle [503772](#)

Material Info

Reference - Drawing Numbers

Application Specification

AS-503772-001-001

Packaging Specification

5037769200-200

Product Specification

PS-503772-001-001, PS-503772-002-001

Sales Drawing

5037760001-000, 5037761001-000

This document was generated on 09/25/2019

PLEASE CHECK WWW.MOLEX.COM FOR LATEST PART INFORMATION