

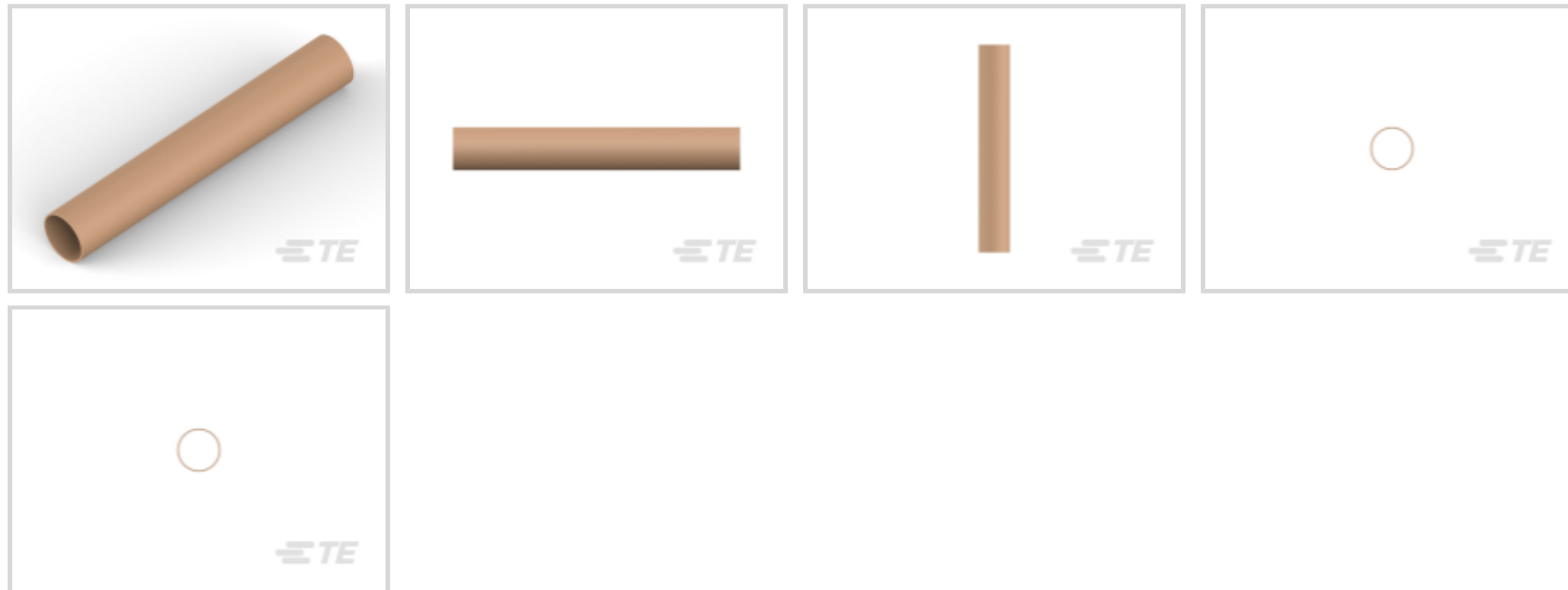

Heat Shrink Tubing > SAS Heat Shrink Tubing



Primary Product Color: **Amber**

Primary Product Material: **Adhesive**

[All SAS Heat Shrink Tubing \(34\)](#)

Features

Body Features

Primary Product Color	Amber
Primary Product Material	Adhesive

Product Compliance

[For compliance documentation, visit the product page on TE.com>](#)

EU RoHS Directive 2011/65/EU	Compliant
EU ELV Directive 2000/53/EC	Compliant
China RoHS 2 Directive MIIT Order No 32, 2016	No Restricted Materials Above Threshold
EU REACH Regulation (EC) No. 1907/2006	Current ECHA Candidate List: JUNE 2024 (241) Candidate List Declared Against: JUN 2020 (209) Does not contain REACH SVHC
Halogen Content	Low Halogen - Br, Cl, F, I < 900 ppm per homogenous material. Also BFR/CFR/PVC Free
Solder Process Capability	Not applicable for solder process capability

Product Compliance Disclaimer



This information is provided based on reasonable inquiry of our suppliers and represents our current actual knowledge based on the information they provided. This information is subject to change. The part numbers that TE has identified as EU RoHS compliant have a maximum concentration of 0.1% by weight in homogenous materials for lead, hexavalent chromium, mercury, PBB, PBDE, DBP, BBP, DEHP, DIBP, and 0.01% for cadmium, or qualify for an exemption to these limits as defined in the Annexes of Directive 2011/65/EU (RoHS2). Finished electrical and electronic equipment products will be CE marked as required by Directive 2011/65/EU. Components may not be CE marked. Additionally, the part numbers that TE has identified as EU ELV compliant have a maximum concentration of 0.1% by weight in homogenous materials for lead, hexavalent chromium, and mercury, and 0.01% for cadmium, or qualify for an exemption to these limits as defined in the Annexes of Directive 2000/53/EC (ELV). Regarding the REACH Regulation, the information TE provides on SVHC in articles for this part number is based on the latest European Chemicals Agency (ECHA) 'Guidance on requirements for substances in articles' posted at this URL: <https://echa.europa.eu/guidance-documents/guidance-on-reach>

Compatible Parts



TE Part # EG1114-000
CV1981-ST-230V1600W-EU

Also in the Series | RAYCHEM SAS

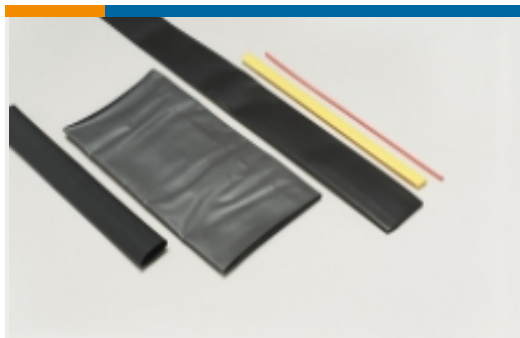

Heat Shrink Tubing(15)

Customers Also Bought

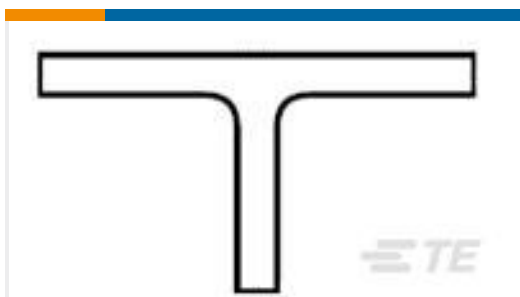

TE Part #811463-000
301A512-50-0

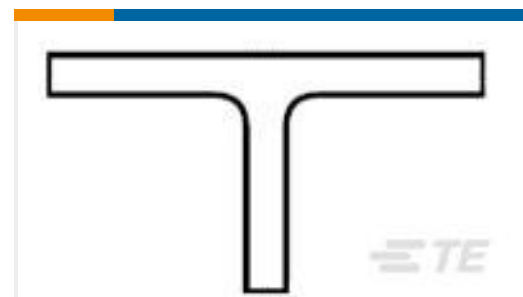

TE Part #720633-000
301A511-51/164-0



TE Part #202758-3
6 PL. BLOCK

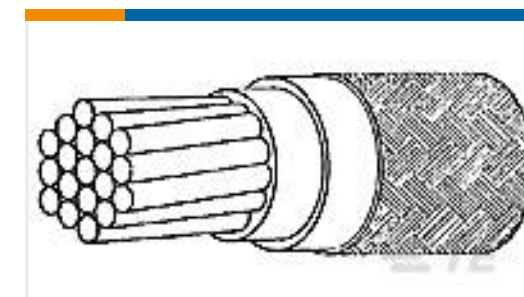

TE Part #262029-001
81044/6-16-9

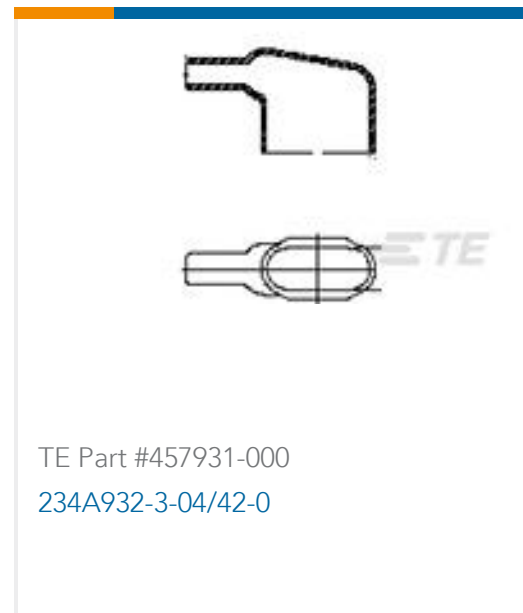
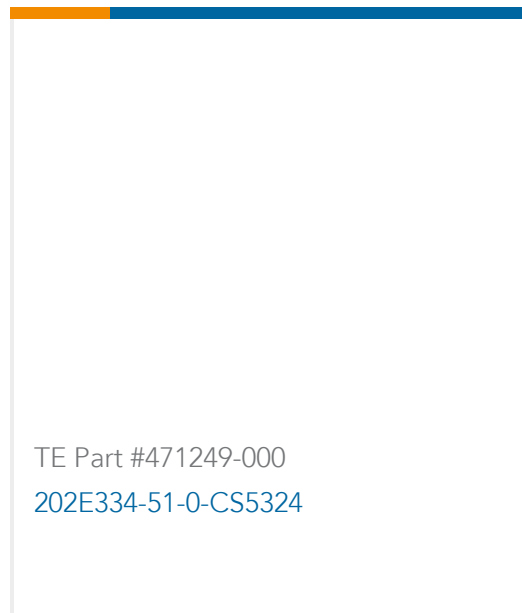

Documents

Product Drawings

[SAS-160-1-1048-1X](#)

English

Datasheets & Catalog Pages

[Measuring_Single_Wall_Tubing](#)

English

[Selecting_Correct_Tubing_1216](#)

English

Product Specifications

[Application Specification](#)

English