

PLEASE CHECK WWW.MOLEX.COM FOR LATEST PART INFORMATION

Part Number: [501931-4070](#)
Status: **Active**
Overview: [Duo-Clasp™](#)
Description: 1.25mm Pitch Duo-Clasp™ Wire-to-Board PCB Receptacle, Dual Row, Vertical, 40 Circuits

Documents:

3D Model	Application Specification AS-503110-002 (PDF)
Drawing (PDF)	Packaging Specification SPK-501931-001 (PDF)
Product Specification PS-501931-002 (PDF)	RoHS Certificate of Compliance (PDF)
Application Specification AS-503110-001 (PDF)	

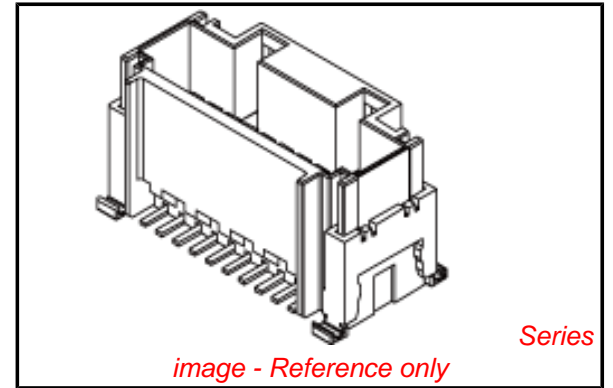

General

Product Family	PCB Receptacles
Series	501931
Application	Signal, Wire-to-Board
Overview	Duo-Clasp™
Product Name	Duo-Clasp™
UPC	822350236065

Physical

Circuits (Loaded)	40
Circuits (maximum)	40
Color - Resin	Natural
Durability (mating cycles max)	30
Glow-Wire Compliant	No
Guide to Mating Part	Yes
Keying to Mating Part	Yes
Lock to Mating Part	Yes
Mated Height	10.95mm
Material - Metal	Copper Alloy
Material - Plating Mating	Gold
Material - Plating Termination	Tin
Net Weight	1668.200/mg
Number of Rows	2
Orientation	Vertical
PCB Locator	No
PCB Retention	Yes
Packaging Type	Embossed Tape on Reel
Pitch - Mating Interface	1.25mm
Polarized to Mating Part	Yes
Polarized to PCB	No
Stackable	No
Temperature Range - Operating	-25°C to +85°C
Termination Interface: Style	Surface Mount

Electrical

Current - Maximum per Contact	1A
Voltage - Maximum	50V AC (RMS)/DC

Material Info

Reference - Drawing Numbers

Application Specification	AS-503110-001, AS-503110-002
Packaging Specification	SPK-501931-001
Product Specification	PS-501931-002, RPS-501931-002, RPS-501931-003, RPS-501931-004

EU RoHS

ELV and RoHS Compliant
REACH SVHC
 Not Reviewed
Low-Halogen Status
Not Low-Halogen

China RoHS



Need more information on product environmental compliance?

Email productcompliance@molex.com
 For a multiple part number RoHS Certificate of Compliance, [click here](#)

Please visit the [Contact Us](#) section for any non-product compliance questions.

Search Parts in this Series

[501931Series](#)

Mates With

[503110 Crimp Housing](#) . [501930 Crimp Terminal](#)

This document was generated on 06/04/2013

PLEASE CHECK WWW.MOLEX.COM FOR LATEST PART INFORMATION