

PLEASE CHECK WWW.MOLEX.COM FOR LATEST PART INFORMATION

Part Number: [501876-2240](#)
Status: **Active**
Overview: [iGrid™](#)
Description: 2.00mm Pitch iGrid™ Wire-to-Board Header, Dual Row, Right Angle, 22 Circuits

Documents:

[3D Model](#) [Packaging Specification SPK-501876-001 \(PDF\)](#)
[Drawing \(PDF\)](#) [RoHS Certificate of Compliance \(PDF\)](#)
[Product Specification PS-501646-001 \(PDF\)](#)

General

Product Family	PCB Headers
Series	501876
Application	Signal, Wire-to-Board
MolexKits	Yes
Overview	iGrid™
Product Name	iGrid™
UPC	822350171038

Physical

Breakaway	No
Circuits (Loaded)	22
Circuits (maximum)	22
Color - Resin	Natural
Durability (mating cycles max)	30
Glow-Wire Compliant	No
Keying to Mating Part	Yes
Lock to Mating Part	Yes
Material - Metal	Brass
Material - Plating Mating	Tin
Material - Plating Termination	Tin
Material - Resin	Nylon
Net Weight	2490.500/mg
Number of Rows	2
Orientation	Right Angle
PC Tail Length	3.20mm
PCB Locator	No
PCB Retention	None
PCB Thickness - Recommended	1.20mm, 1.60mm
Packaging Type	Tray
Pitch - Mating Interface	2.00mm
Polarized to Mating Part	Yes
Polarized to PCB	No
Stackable	No
Surface Mount Compatible (SMC)	No
Temperature Range - Operating	-25°C to +85°C
Termination Interface: Style	Through Hole

Electrical

Current - Maximum per Contact	2A
Voltage - Maximum	250V AC (RMS)/DC

Material Info

Reference - Drawing Numbers

Packaging Specification	SPK-501876-001
-------------------------	----------------

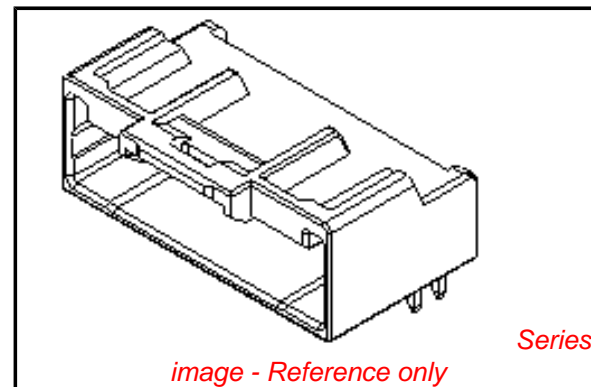

image - Reference only

EU RoHS

**ELV and RoHS
Compliant**

REACH SVHC

Not Reviewed

Low-Halogen Status

Not Low-Halogen

China RoHS



**Need more information on product
environmental compliance?**

Email productcompliance@molex.com
For a multiple part number RoHS Certificate of Compliance, [click here](#)

Please visit the [Contact Us](#) section for any non-product compliance questions.

Search Parts in this Series

[501876Series](#)

Mates With

501646 Housing, 501647 Crimp Terminal
22-26 AWG, [501648](#) Crimp Terminal 26-28
AWG

Product Specification

Sales Drawing

PS-501646-001, RPS-501646-001, RPS-501646-002,
RPS-501646-003, RPS-501646-004, RPS-501646-005,
RPS-501646-006, RPS-501646-007
SD-501876-001

This document was generated on 07/10/2013

PLEASE CHECK WWW.MOLEX.COM FOR LATEST PART INFORMATION