

PLEASE CHECK WWW.MOLEX.COM FOR LATEST PART INFORMATION

Part Number: [501645-1620](#)
Status: **Active**
Overview: iGrid™
Description: 2.00mm Pitch iGrid™ Wire-to-Board Header, Dual Row, Vertical, with PCB Locator, 16 Circuits, Lead-Free

Documents:

[3D Model](#) [Packaging Specification SPK-501645-001 \(PDF\)](#)
[Drawing \(PDF\)](#) [RoHS Certificate of Compliance \(PDF\)](#)
[Product Specification PS-501646-001 \(PDF\)](#)

General

Product Family	PCB Headers
Series	501645
Application	Signal, Wire-to-Board
MolexKits	Yes
Overview	iGrid™
Product Name	iGrid™
UPC	822350201506

Physical

Breakaway	No
Circuits (Loaded)	16
Circuits (maximum)	16
Color - Resin	Natural
Durability (mating cycles max)	30
Glow-Wire Compliant	No
Keying to Mating Part	Yes
Lock to Mating Part	Yes
Material - Metal	Brass
Material - Plating Mating	Tin
Material - Plating Termination	Tin
Material - Resin	Nylon
Net Weight	1028.400/mg
Number of Rows	2
Orientation	Vertical
PC Tail Length	3.20mm
PCB Locator	Yes
PCB Retention	None
PCB Thickness - Recommended	1.20mm, 1.60mm
Packaging Type	Tray
Pitch - Mating Interface	2.00mm
Polarized to Mating Part	Yes
Polarized to PCB	Yes
Stackable	No
Surface Mount Compatible (SMC)	No
Temperature Range - Operating	-25°C to +85°C
Termination Interface: Style	Through Hole

Electrical

Current - Maximum per Contact	2A
Voltage - Maximum	250V AC (RMS)/DC

Material Info

Reference - Drawing Numbers

Packaging Specification	SPK-501645-001
-------------------------	----------------

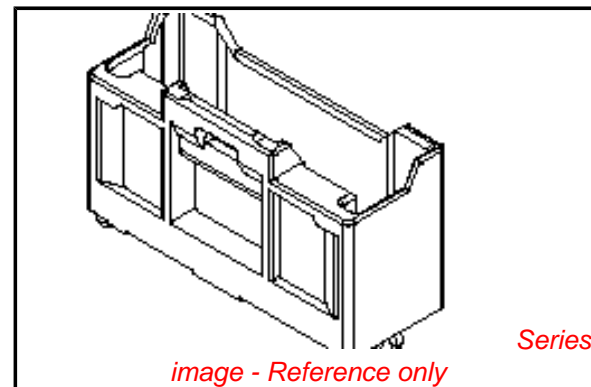

EU RoHS

ELV and RoHS Compliant
REACH SVHC Contains SVHC: No
Low-Halogen Status
Not Low-Halogen

China RoHS



Need more information on product environmental compliance?

Email productcompliance@molex.com
 For a multiple part number RoHS Certificate of Compliance, [click here](#)

Please visit the [Contact Us](#) section for any non-product compliance questions.

Search Parts in this Series

501645Series

Mates With

501646 Housing, 501647 Crimp Terminal 22-26 AWG, 501648 Crimp Terminal 26-28 AWG

Product Specification

PS-501646-001, RPS-501646-001, RPS-501646-002,
RPS-501646-003, RPS-501646-004, RPS-501646-005,
RPS-501646-006, RPS-501646-007, RPS-501646-008,
RPS-501646-010
SD-501645-001

Sales Drawing

This document was generated on 07/10/2013

PLEASE CHECK WWW.MOLEX.COM FOR LATEST PART INFORMATION