

RK 90 - Keycap body, for lens 2-module

5.55.103.077/1013

Please order lens separately.



General information

Color of lens	-
Size	2-module
Degree of protection (with silicon seal)	IP65 (DIN EN 60529)
Illuminability	yes

Dimensions

Dimension (b) in front of front panel	13.85 x 27.85 mm
Dimension (a) behind front panel	17.20 x 31.20 mm
Dimension (c) hole patterns final size	14.00 x 28.00 mm
Dimension hole patterns punched size	14.20 x 28.20 mm

Other specifications

ROHS compliant	yes
REACH compliant	yes

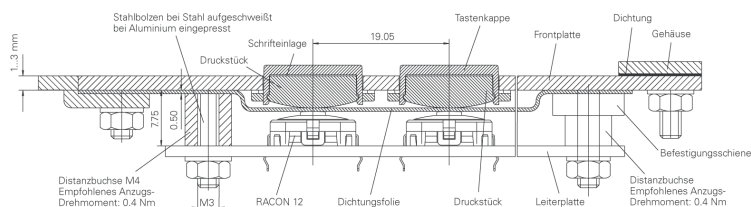
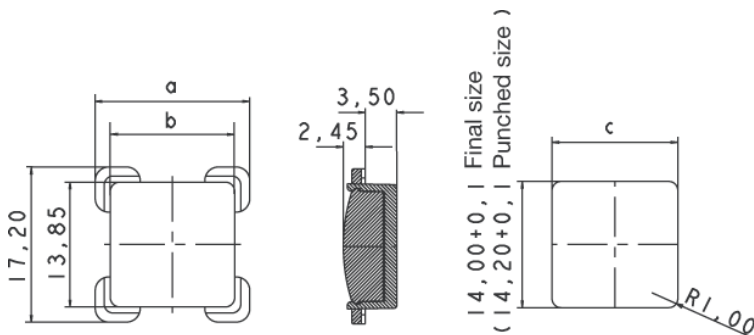

Einbau von vorne

Einbau von hinten

