

## RACON, round plunger 14.5 mm, L 1.4 mm



### fields of application

- > Measurement-control-regulation
- > Mechanical and system engineering
- > Automotive
- > Signalling systems
- > Vehicle construction
- > Handheld terminals

### description

The wide selection of standard plungers in different shapes and colors guarantees a versatile range of applications for the RACON tactile switch.

### technical data

#### > general

Color	white
Collar shape	round
illuminated	No
Packaging unit	500 pcs.
net weight	0.2 g
MOQ order	1,000 pcs.
RoHS compliant	Yes
REACH compliant	Yes
Component material	Plastic

#### direct links

- > [RAFI eCatalog](#)

#### > mounting diameters

Outside dimension, length	2.9 mm
Outside dimension, width	14.5 mm
Outside dimension, height	14.5 mm
Plunger length L	1.4 mm

**drawings**

**Dimensioned drawing**

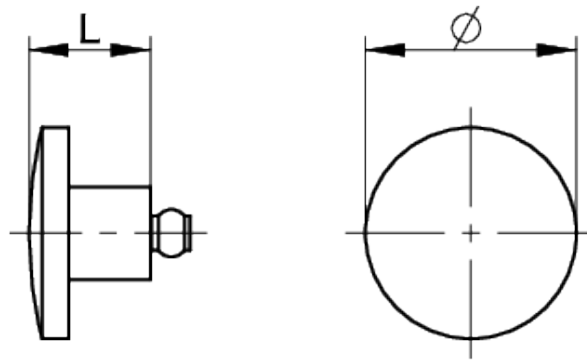

**System drawing**

SMT gullwing connection

Recommended: Embossing: 0.35 mm

Adhesive thickness: 0.15 mm

