



MQS

TE Internal #: 5-968893-1

Automotive Terminals, Receptacle, Mating Tab Width .63 mm [.025 in], Tab Thickness .63 mm [.025 in], 24 – 22 AWG Wire Size, MQS

[View on TE.com >](#)

Terminals & Splices > Automotive Terminals > MQS, RECEPTACLE AND TAB



Terminal Type: **Receptacle**

Mating Tab Width: **.63 mm [.025 in]**

Mating Tab Thickness: **.63 mm [.025 in]**

Terminal Transmits: **0 – 24 A (Low Power)**

Wire Size: **24 – 22 AWG**

[All MQS, RECEPTACLE AND TAB \(108\)](#)

Features

Product Type Features

Receptacle Style	180°
Sealable	No
Primary Locking Feature	Locking Lance

Contact Features

Contact Size	.63mm
Contact Fabrication	Stamped & Formed
Wire Contact Termination Area Plating Material	Gold
Typical Current Rating	7.5 A
Crimp Type	F-Crimp
Terminal Type	Receptacle
Mating Tab Width	.63 mm[.025 in]
Mating Tab Thickness	.63 mm[.025 in]
Interface Plating	Gold (Au)

Termination Features

Termination Method to Wire & Cable	Crimp
Product Terminates To	Wire



Dimensions

Compatible Insulation Diameter Range	1.1 – 1.6 mm [.043 – .063 in]
Wire Size	.2 – .35 mm ²
Wire Size Search	22 AWG, 23 AWG, 24 AWG

Usage Conditions

Insulation Option	Uninsulated
Operating Temperature (Max)	80 °C, 85 °C, 90 °C, 100 °C, 105 °C, 110 °C, 120 °C, 125 °C, 130 °C, 140 °C [176 °F][185 °F][194 °F][212 °F][221 °F][230 °F][248 °F][257 °F][266 °F][284 °F]
Operating Temperature Range	-40 – 140 °C [-40 – 284 °F]

Operation/Application

Compatible With Wire Base Material	Copper
------------------------------------	--------

Industry Standards

Compatible With Agency/Standards Products	LV214
---	-------

Packaging Features

Packaging Quantity	13000
Packaging Method	Reel

Other

Terminal Transmits	0 – 24 A (Low Power)
--------------------	----------------------

Product Compliance

[For compliance documentation, visit the product page on TE.com>](#)

EU RoHS Directive 2011/65/EU	Compliant
EU ELV Directive 2000/53/EC	Compliant
China RoHS 2 Directive MIIT Order No 32, 2016	No Restricted Materials Above Threshold
EU REACH Regulation (EC) No. 1907/2006	Current ECHA Candidate List: JUNE 2023 (235) Candidate List Declared Against: JUNE 2023 (235) Does not contain REACH SVHC
Halogen Content	Low Halogen - Br, Cl, F, I < 900 ppm per homogenous material. Also BFR/CFR/PVC Free
Solder Process Capability	Not reviewed for solder process capability

Product Compliance Disclaimer

This information is provided based on reasonable inquiry of our suppliers and represents our current actual knowledge based on the information they provided. This information is subject to change. The part numbers that TE has identified as EU RoHS compliant have a maximum concentration of 0.1% by weight in homogenous materials for lead, hexavalent chromium, mercury, PBB, PBDE, DBP, BBP, DEHP, DIBP, and 0.01% for cadmium, or qualify for an exemption to these limits as defined in the Annexes of Directive 2011/65/EU (RoHS2). Finished electrical and electronic equipment products will be CE marked as required by Directive 2011/65/EU. Components may not be CE marked. Additionally, the part numbers that TE has identified as EU ELV compliant have a maximum concentration of 0.1% by weight in homogenous materials for lead, hexavalent chromium, and mercury, and 0.01% for cadmium, or qualify for an exemption to these limits as defined in the Annexes of Directive 2000/53/EC (ELV). Regarding the REACH Regulation, the information TE provides on SVHC in articles for this part number is based on the latest European Chemicals Agency (ECHA) 'Guidance on requirements for substances in articles' posted at this URL: <https://echa.europa.eu/guidance-documents/guidance-on-reach>

Compatible Parts



TE Part # 6-1579007-1
EXTRACTION TOOL



TE Part # 2208304-3
8POS, MQS, REC HSG, WITH SB, ASSY



TE Part # 2151493-1
OCEAN_2.0_APPLICATOR-S-055F072O



TE Part # 2151493-2
OCEAN_2.0_APPLICATOR-S-055F072O



TE Part # 2208304-1
8POS MQS REC



TE Part # 2208304-2
8POS, MQS, REC HSG, WITH SB, ASSY



TE Part # 2305570-1
Strip Terminal Cutter-Side Feed-No Crimp



TE Part # 5-2151493-1
OCEAN_2.0_APPLICATOR-S-055F072O



TE Part # 5-2151493-2
OCEAN_2.0_APPLICATOR-S-055F072O



TE Part # 7-2151493-1
OCEAN_2.0_APPLICATOR-S-055F072O



TE Part # 7-2151493-2
OCEAN_2.0_APPLICATOR-S-055F072O



TE Part # 7-2151493-7
OCEAN_2.0_SPARE_PART_KIT-055F072O



TE Part # 7-2151541-1
OCEAN_2.0_APPLICATOR-S-050F072O



TE Part # 7-2151541-2
OCEAN_2.0_APPLICATOR-S-050F072O



KIT
REPRESENTATION ONLY

TE Part # 7-2266152-7
OC-055F072O-752-CRIMPTOOLINGKIT



TE Part # 2386459-1
EXTRACTION TOOL



TE Part # 3-2151493-2
OCEAN_2.0_APPLICATOR-S-055F072O

Also in the Series | MQS



Automotive Connector Caps & Covers (111)



Automotive Connector EMC Shielding (3)



Automotive Connector Locks & Position Assurance(27)



Automotive Housings(375)



Automotive Terminals(88)



Connector Seals & Cavity Plugs(26)



Insertion & Extraction Tools(42)



Other Automotive Connector Accessories(7)



PCB Headers & Receptacles(143)

Customers Also Bought

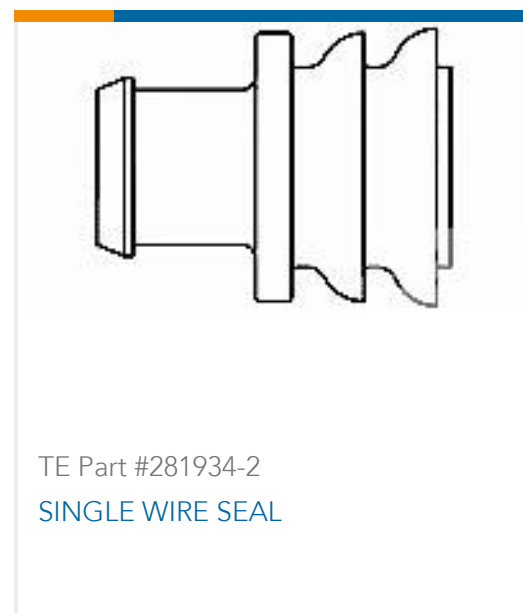

Documents

Product Drawings

MQS0,63 Au rec LL unseal. 0,2-0,35

English

CAD Files

Customer View Model

[ENG_CVM_CVM_5-968893-1_A.2d_dxf.zip](#)

English

3D PDF

3D

Customer View Model

[ENG_CVM_CVM_5-968893-1_A.3d_igs.zip](#)

English

Customer View Model

[ENG_CVM_CVM_5-968893-1_A.3d_stp.zip](#)

English

By downloading the CAD file I accept and agree to the [Terms and Conditions](#) of use.

Datasheets & Catalog Pages

Micro Quadlok Interconnection System (MQS)

English

Product Specifications

Application Specification

English

Application Specification

English



Application Specification

German