



TE Internal #: 5-531355-3

Connector Contact, Socket, Wire-to-Board, 10 – 12 AWG Wire Size, 6530 – 10383 CMA Wire Size, 3.31 – 5.26 mm² Wire Size, Gold, Wire & Cable, 5 A

[View on TE.com >](#)

Connectors > PCB Connectors > Wire-to-Board Connectors > Wire-to-Board Connector Contacts

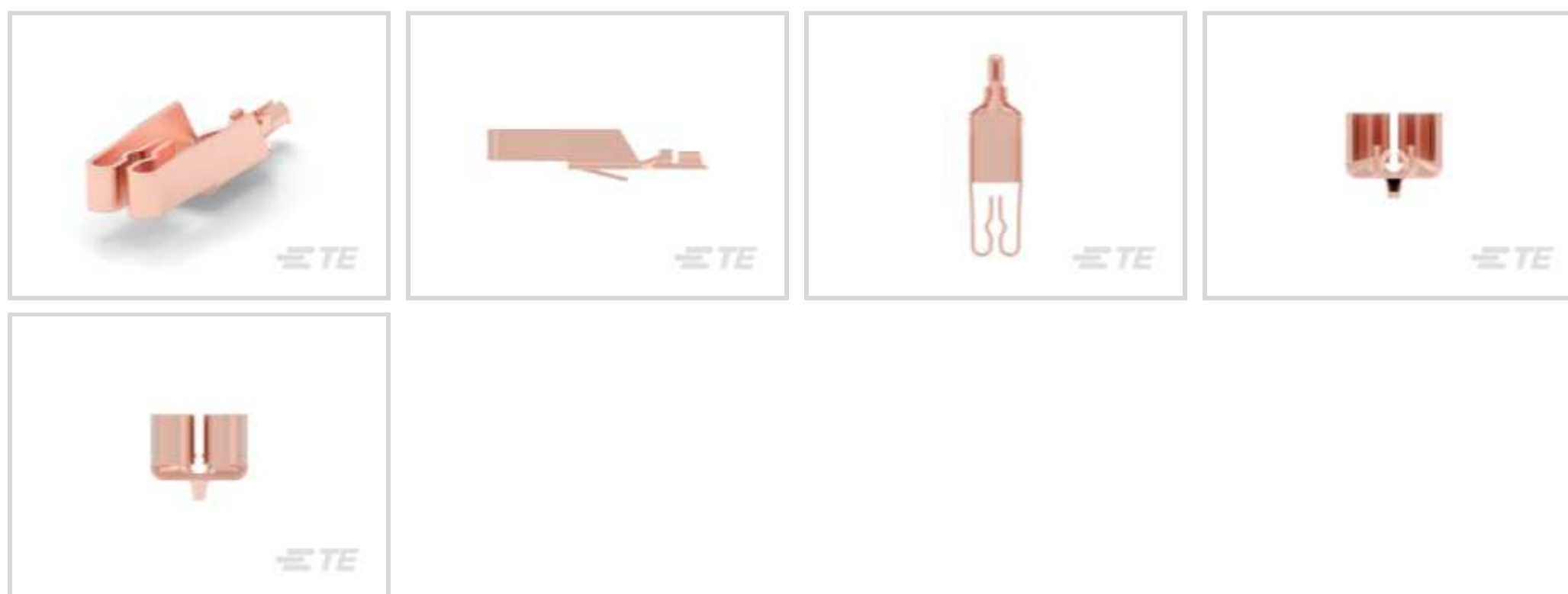

Contact Type: **Socket**

Connector System: **Wire-to-Board**

Wire Size: **3.31 – 5.26 mm²**

Features

Product Type Features

Connector System	Wire-to-Board
Sealable	No
Connector & Contact Terminates To	Wire & Cable

Contact Features

Contact Type	Socket
Contact Mating Area Plating Material	Gold
Contact Current Rating (Max)	5 A

Dimensions

Wire Size	3.31 – 5.26 mm ²
-----------	-----------------------------

Operation/Application

Circuit Application	Power & Signal
---------------------	----------------

Product Compliance

[For compliance documentation, visit the product page on TE.com>](#)

EU RoHS Directive 2011/65/EU	Compliant
EU ELV Directive 2000/53/EC	Compliant







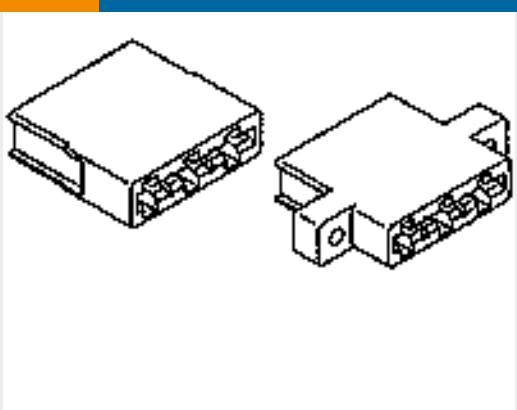
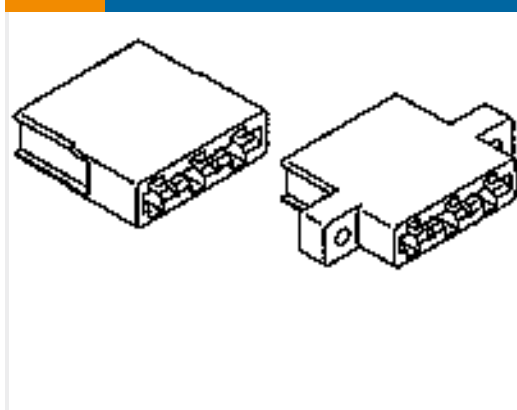
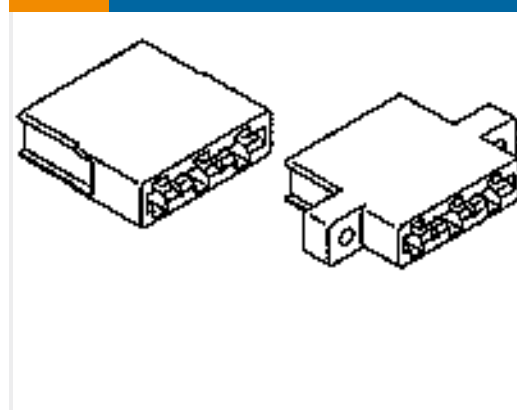

China RoHS 2 Directive MIIT Order No 32, 2016	No Restricted Materials Above Threshold
EU REACH Regulation (EC) No. 1907/2006	Current ECHA Candidate List: JAN 2023 (233) Candidate List Declared Against: JAN 2023 (233) Does not contain REACH SVHC
Halogen Content	Low Halogen - Br, Cl, F, I < 900 ppm per homogenous material. Also BFR/CFR/PVC Free
Solder Process Capability	Wave solder capable to 240°C

Product Compliance Disclaimer

This information is provided based on reasonable inquiry of our suppliers and represents our current actual knowledge based on the information they provided. This information is subject to change. The part numbers that TE has identified as EU RoHS compliant have a maximum concentration of 0.1% by weight in homogenous materials for lead, hexavalent chromium, mercury, PBB, PBDE, DBP, BBP, DEHP, DIBP, and 0.01% for cadmium, or qualify for an exemption to these limits as defined in the Annexes of Directive 2011/65/EU (RoHS2). Finished electrical and electronic equipment products will be CE marked as required by Directive 2011/65/EU. Components may not be CE marked. Additionally, the part numbers that TE has identified as EU ELV compliant have a maximum concentration of 0.1% by weight in homogenous materials for lead, hexavalent chromium, and mercury, and 0.01% for cadmium, or qualify for an exemption to these limits as defined in the Annexes of Directive 2000/53/EC (ELV). Regarding the REACH Regulation, the information TE provides on SVHC in articles for this part number is based on the latest European Chemicals Agency (ECHA) 'Guidance on requirements for substances in articles' posted at this URL: <https://echa.europa.eu/guidance-documents/guidance-on-reach>

Compatible Parts

 <p>TE Part # 530521-6 HIGH CURRENT HSG 8 POS</p>	 <p>TE Part # 530521-9 HIGH CURRENT HSG 12 POS</p>	 <p>TE Part # 530521-7 HIGH CURRENT HSG 9 POS</p>	 <p>TE Part # 1-530521-1 HOUSING</p>
 <p>TE Part # 1-530521-3 HOUSING</p>	 <p>TE Part # 1-530521-4 HOUSING</p>	 <p>TE Part # 1-530521-5 HOUSING</p>	 <p>TE Part # 1-530521-6 HOUSING</p>

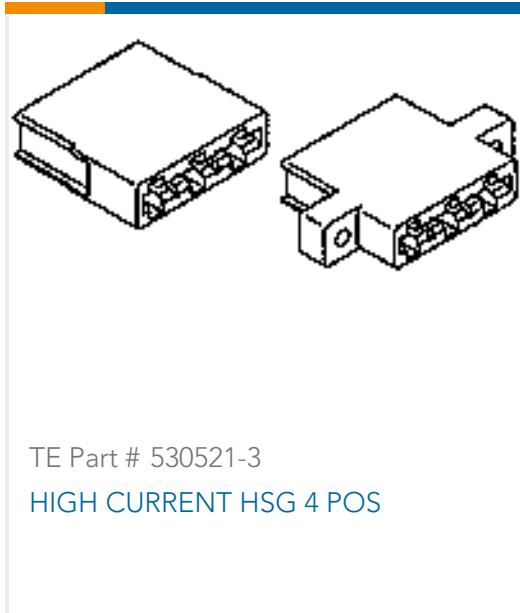

Customers Also Bought



Documents

[CAD Files](#)

[3D PDF](#)

[3D](#)

[Customer View Model](#)

[ENG_CVM_CVM_5-531355-3_Z.2d_dxf.zip](#)

English

[Customer View Model](#)

[ENG_CVM_CVM_5-531355-3_Z.3d_igs.zip](#)

English



Customer View Model

[ENG_CVM_CVM_5-531355-3_Z.3d_stp.zip](#)

English

By downloading the CAD file I accept and agree to the [Terms and Conditions](#) of use.

Product Specifications

[Application Specification](#)

English

Product Environmental Compliance

[TE Material Declaration](#)

English