

5-100526-9 ✓ ACTIVE

Z-PACK | Z-PACK 2mm HM

TE Internal #: 5-100526-9

Coding Key, Slate Gray, Z-PACK 2mm HM

[View on TE.com >](#)



Connectors > Connector Accessories > Connector Hardware

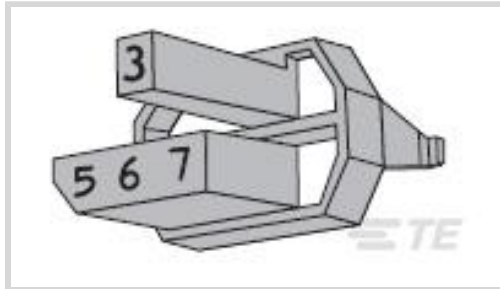

Hardware Accessory Function: **Coding & Keying**

Connector Hardware Accessory Type: **Coding Key**

Primary Product Color: **Slate Gray**

Features

Product Type Features

Hardware Accessory Function	Coding & Keying
Connector Hardware Accessory Type	Coding Key

Body Features

Connector & Keying Code	1258
Primary Product Color	Slate Gray

Usage Conditions

Compatible With Connector Style	Receptacle
---------------------------------	------------

Packaging Features

Packaging Quantity	500
Packaging Method	Bag

Product Compliance

[For compliance documentation, visit the product page on TE.com>](#)

EU RoHS Directive 2011/65/EU	Compliant
EU ELV Directive 2000/53/EC	Compliant
China RoHS 2 Directive MIIT Order No 32, 2016	No Restricted Materials Above Threshold
EU REACH Regulation (EC) No. 1907/2006	Current ECHA Candidate List: JUNE 2023 (235) Candidate List Declared Against: JUL 2021 (219) Does not contain REACH SVHC
Halogen Content	Low Halogen - Br, Cl, F, I < 900 ppm per homogenous material. Also BFR/CFR/PVC

Free

Solder Process Capability

Not applicable for solder process capability

Product Compliance Disclaimer

This information is provided based on reasonable inquiry of our suppliers and represents our current actual knowledge based on the information they provided. This information is subject to change. The part numbers that TE has identified as EU RoHS compliant have a maximum concentration of 0.1% by weight in homogenous materials for lead, hexavalent chromium, mercury, PBB, PBDE, DBP, BBP, DEHP, DIBP, and 0.01% for cadmium, or qualify for an exemption to these limits as defined in the Annexes of Directive 2011/65/EU (RoHS2). Finished electrical and electronic equipment products will be CE marked as required by Directive 2011/65/EU. Components may not be CE marked. Additionally, the part numbers that TE has identified as EU ELV compliant have a maximum concentration of 0.1% by weight in homogenous materials for lead, hexavalent chromium, and mercury, and 0.01% for cadmium, or qualify for an exemption to these limits as defined in the Annexes of Directive 2000/53/EC (ELV). Regarding the REACH Regulation, the information TE provides on SVHC in articles for this part number is based on the latest European Chemicals Agency (ECHA) 'Guidance on requirements for substances in articles' posted at this URL: <https://echa.europa.eu/guidance-documents/guidance-on-reach>

Compatible Parts

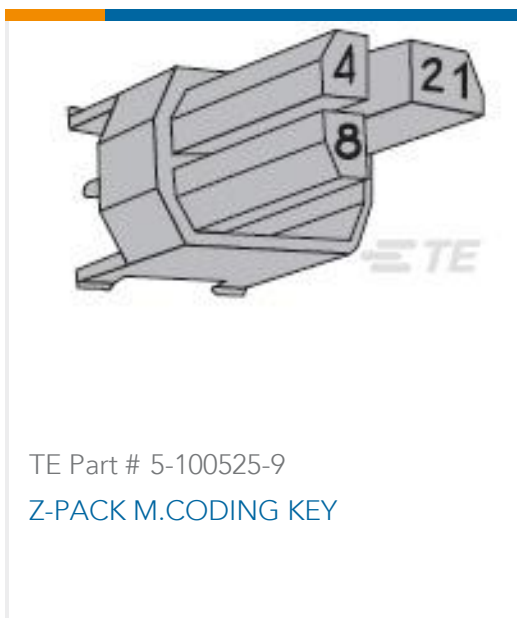

Also in the Series | Z-PACK 2mm HM

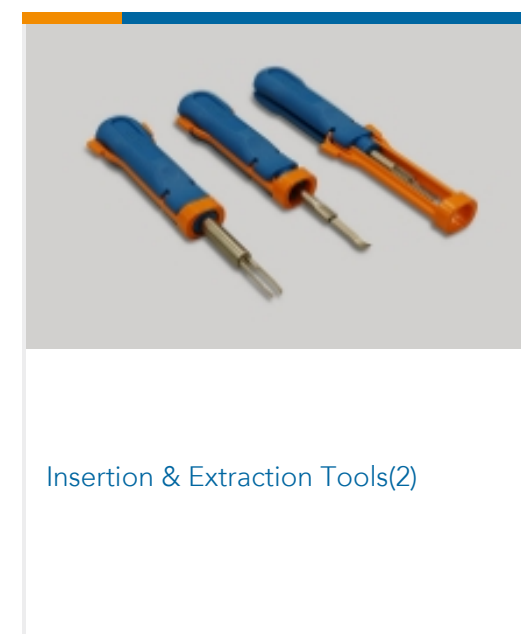
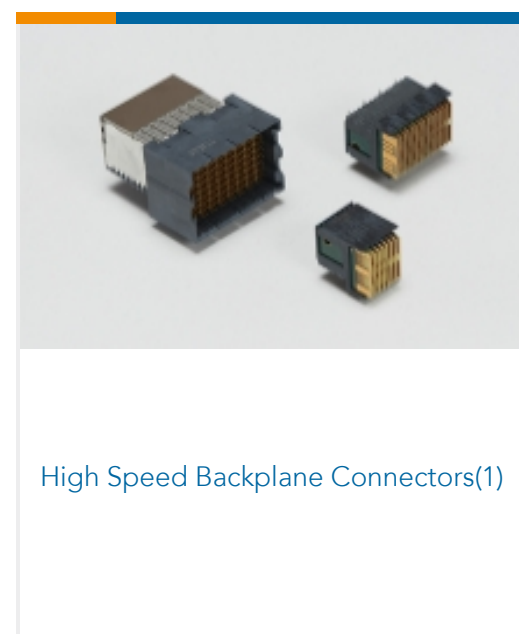
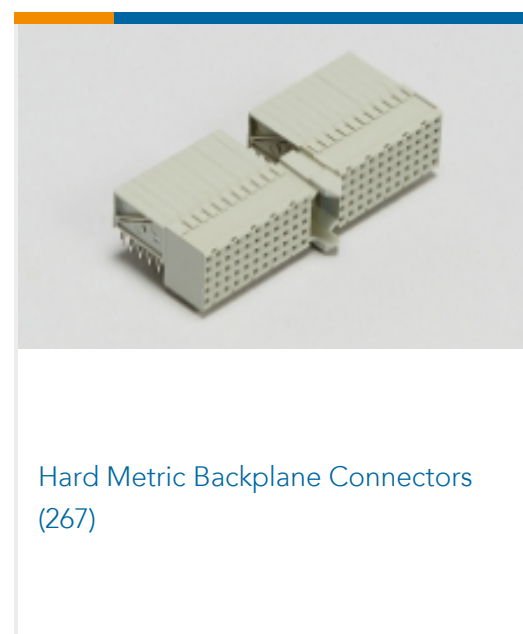
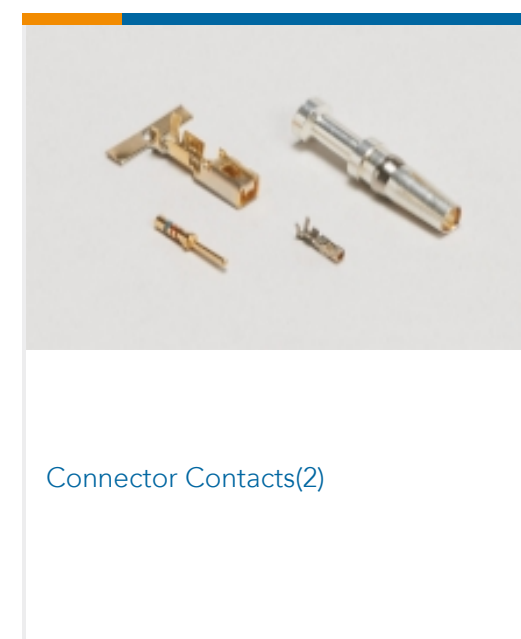
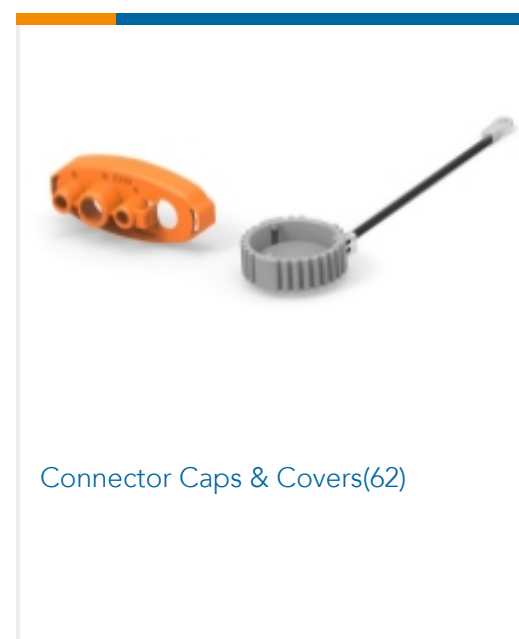
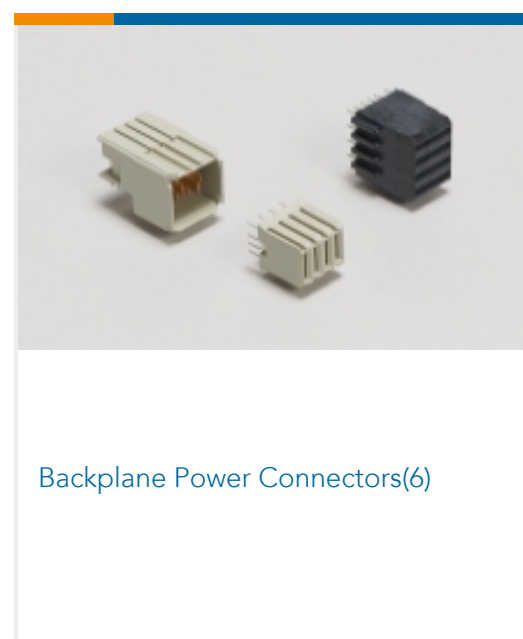
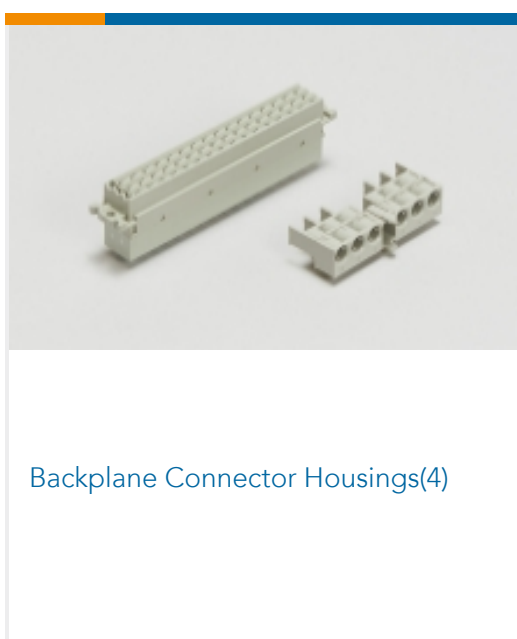



Rectangular Power Connectors(87)

Customers Also Bought

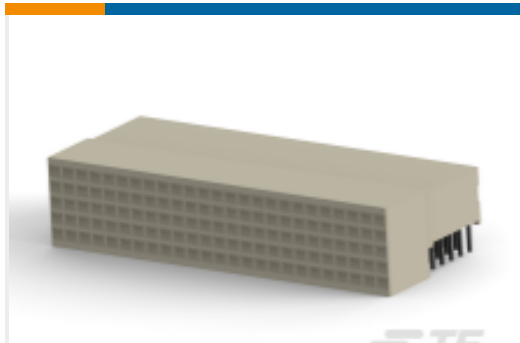

TE Part #5352152-1
HM Receptacle Connector: Traditional Backplane, Coplanar, 2mm



TE Part #2102736-1
BP, Center, MULTIGIG RT 2R



TE Part #350547-6
UMNL PIN 20-14 AU/PHBZ L/P

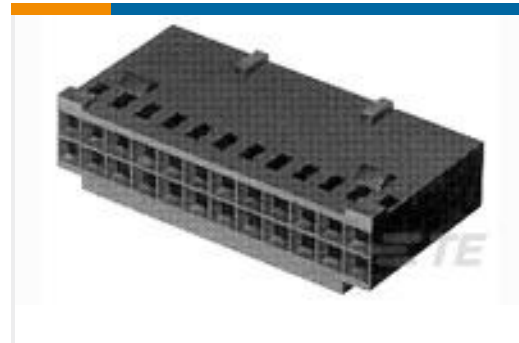

TE Part #2-87631-6
30 MODIV HSG DR MRKD .100 POL



TE Part #3-1617118-1
J1MACDD-26XM = M39016/24-030M

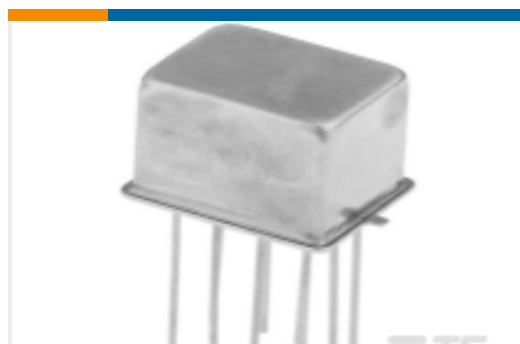

TE Part #9-1617591-5
JMGAT-18MW=M28776/6-011M

Documents

Product Drawings

Z-PACK F.CODING KEY

English

CAD Files

3D PDF

3D

Customer View Model

[ENG_CVM_CVM_5-100526-9_E.2d_dxf.zip](#)

English

Customer View Model

[ENG_CVM_CVM_5-100526-9_E.3d_igs.zip](#)

English

Customer View Model

[ENG_CVM_CVM_5-100526-9_E.3d_stp.zip](#)

English

By downloading the CAD file I accept and agree to the [Terms and Conditions](#) of use.



[Product Specifications](#)

[Application Specification](#)

English