

PLEASE CHECK WWW.MOLEX.COM FOR LATEST PART INFORMATION

Part Number: [0466250500](#)
Status: **Active**
Overview: [Micro-Fit Connector System](#)
Description: Micro-Fit BMI Plug Housing, Single Row, Panel Mount, 5 Circuits, Nylon,UL 94V-0

Documents:

3D Model	Packaging Specification 466250000-PK-000 (PDF)
3D Model (PDF)	RoHS Certificate of Compliance (PDF)
Drawing (PDF)	Product Literature (PDF)
Product Specification PS-44300-001-001 (PDF)	

Agency Certification

CSA	LR19980
UL	E29179

General

Product Family	Crimp Housings
Series	46625
Application	Power, Wire-to-Board, Wire-to-Wire
Overview	Micro-Fit Connector System
Product Name	Micro-Fit BMI
UPC	887191386713

Physical

Circuits (maximum)	5
Color - Resin	Black
Flammability	94V-0
Gender	Plug
Glow-Wire Capable	No
Lock to Mating Part	No
Material - Resin	Nylon
Net Weight	1.976/g
Number of Rows	1
Packaging Type	Bag
Panel Mount	Yes
Pitch - Mating Interface	3.00mm
Polarized to Mating Part	Yes
Stackable	No
Temperature Range - Operating	-40° to +105°C

Solder Process Data

Lead-freeProcess Capability	N/A
-----------------------------	-----

Material Info

Reference - Drawing Numbers

Packaging Specification	466250000-PK-000
Product Specification	PS-44300-001-001
Sales Drawing	SD-46625-001-001

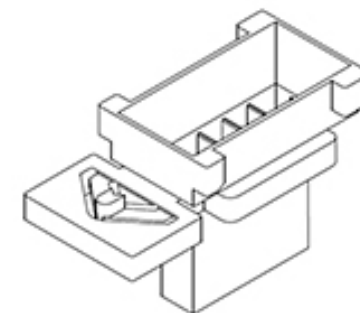

Series image - Reference only

EU ELV

Not Relevant

EU RoHS

Compliant

REACH SVHC

Not Contained Per -
D(2020)4578-DC (25
June 2020)

Halogen-Free

Status

Low-Halogen

For more information, please visit [Contact US](#)

China ROHS

ELV

RoHS Phthalates

China RoHS

Green Image

Not Relevant

Not Contained

Search Parts in this Series

[46625 Series](#)

Mates With

Micro-Fit BMI Receptacle Housing [46623](#)

Use With

Micro-Fit 3.0 Crimp Terminals [43031](#)

Micro-Fit 3.0 Pre-Crimped Lead [214762](#) ,
[214763](#)