

**PLEASE CHECK WWW.MOLEX.COM FOR LATEST PART INFORMATION**

**Part Number:** [0444750411](#)  
**Status:** **Active**  
**Overview:** [minifit\\_plus\\_hcs](#)  
**Description:** 4.20mm Pitch Mini-Fit® HCS Receptacle Header, Dual Row, Vertical, Blind Mating, with Snap-in Plastic Pegs, 4 Circuits

**Documents:**

[3D Model](#) [Product Specification PS-44476-001 \(PDF\)](#)  
[Drawing \(PDF\)](#) [RoHS Certificate of Compliance \(PDF\)](#)

**Agency Certification**

CSA LR19980  
 UL E29179

**General**

Product Family PCB Receptacles  
 Series [44475](#)  
 Application Board-to-Board, Power, Wire-to-Board  
 Comments Solder Type|With Pegs  
 Overview [minifit\\_plus\\_hcs](#)  
 Product Name Mini-Fit® HCS

**Physical**

Circuits (Loaded) 4  
 Color - Resin Natural  
 Durability (mating cycles max) 30  
 Flammability 94V-2  
 Glow-Wire Compliant No  
 Material - Metal Copper  
 Material - Plating Mating Tin  
 Material - Plating Termination Tin  
 Material - Resin Nylon  
 Number of Rows 2  
 Orientation Vertical  
 PCB Locator Yes  
 PCB Retention Yes  
 PCB Thickness - Recommended 1.60mm  
 Packaging Type Tray  
 Pitch - Mating Interface 4.20mm  
 Plating min - Mating 2.540µm  
 Plating min - Termination 2.540µm  
 Polarized to PCB Yes  
 Surface Mount Compatible (SMC) No  
 Temperature Range - Operating -40°C to +105°C  
 Termination Interface: Style Through Hole

**Electrical**

Current - Maximum per Contact 11A  
 Voltage - Maximum 600V

**Solder Process Data**

Duration at Max. Process Temperature (seconds) 5  
 Lead-free Process Capability Wave Capable (TH only)  
 Max. Cycles at Max. Process Temperature 1  
 Process Temperature max. C 240

**Material Info**

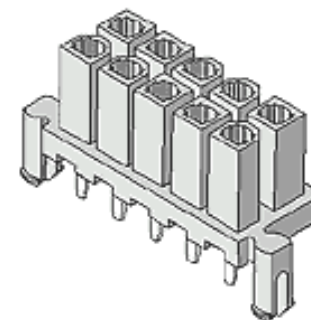

Series

image - Reference only

**EU RoHS**

**ELV and RoHS Compliant**  
**REACH SVHC Contains SVHC: No**  
**Low-Halogen Status Low-Halogen**

**China RoHS**



**Need more information on product environmental compliance?**

Email [productcompliance@molex.com](mailto:productcompliance@molex.com)  
 For a multiple part number RoHS Certificate of Compliance, [click here](#)

Please visit the [Contact Us](#) section for any non-product compliance questions.

**Search Parts in this Series**

[44475Series](#)

**Mates With**

Mini-Fit® SMC 44068 , 43810 , Mini-Fit® BMI Header 42404 , Mini-Fit® HCS [44474](#) , Mini-Fit® BMI Plug Housing [42475](#)

**Reference - Drawing Numbers**

Product Specification  
Sales Drawing

PS-44476-001, RPS-44476-001  
SDA-44475-\*\*\*\*

This document was generated on 01/20/2012

**PLEASE CHECK [WWW.MOLEX.COM](http://WWW.MOLEX.COM) FOR LATEST PART INFORMATION**