

PLEASE CHECK WWW.MOLEX.COM FOR LATEST PART INFORMATION

Part Number: [44428-2205](#)
Status: **Active**
Overview: Micro-Fit 3.0™ Connectors
Description: 3.00mm Pitch Micro-Fit 3.0 BMI™ Header, Surface Mount Compatible, Dual Row, Right Angle, without Snap-in Plastic Peg PCB Lock, 22 Circuits, 0.38µm Gold (Au) Selective Plating

Documents:

3D Model	RoHS Certificate of Compliance (PDF)
Drawing (PDF)	Product Literature (PDF)
Product Specification PS-44300-001 (PDF)	

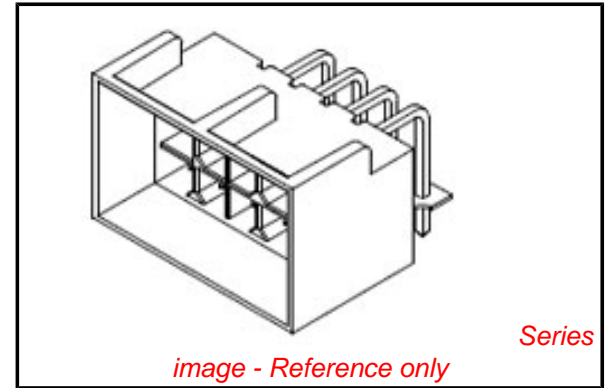

image - Reference only

Agency Certification

CSA	LR19980
TUV	R72081037
UL	E29179

General

Product Family	PCB Headers
Series	44428
Application	Board-to-Board, Power, Wire-to-Board
Comments	High Temperature Square Pin Solder Type Polarized to Mating Part
Overview	Micro-Fit 3.0™ Connectors
Product Literature Order No	987650-5984
Product Name	Micro-Fit 3.0 BMI™
UPC	756054350843

Physical

Breakaway	No
Circuits (Loaded)	22
Circuits (maximum)	22
Color - Resin	Black
Durability (mating cycles max)	30
First Mate / Last Break	No
Flammability	94V-0
Glow-Wire Compliant	No
Guide to Mating Part	No
Keying to Mating Part	None
Lock to Mating Part	Yes
Material - Metal	Brass
Material - Plating Mating	Gold
Material - Plating Termination	Tin
Material - Resin	High Temperature Thermoplastic
Net Weight	4.363/g
Number of Rows	2
Orientation	Right Angle
PC Tail Length	3.50mm
PCB Locator	Yes
PCB Retention	Yes
PCB Thickness - Recommended	1.60mm
Packaging Type	Tray
Pitch - Mating Interface	3.00mm
Plating min - Mating	0.381µm
Plating min - Termination	2.540µm
Polarized to PCB	Yes

EU RoHS

ELV and RoHS Compliant
REACH SVHC Contains SVHC: No
Low-Halogen Status Not Low-Halogen

China RoHS



Need more information on product environmental compliance?

Email productcompliance@molex.com
 For a multiple part number RoHS Certificate of Compliance, [click here](#)

Please visit the [Contact Us](#) section for any non-product compliance questions.

Search Parts in this Series

[44428Series](#)

Mates With

[44133](#) , [44764](#) , [44769](#)

Shrouded	Fully
Stackable	No
Surface Mount Compatible (SMC)	Yes
Temperature Range - Operating	-40°C to +105°C
Termination Interface: Style	Through Hole

Electrical

Current - Maximum per Contact	5A
Voltage - Maximum	250V

Solder Process Data

Duration at Max. Process Temperature (seconds)	5
Lead-free Process Capability	Wave Capable (TH only)
Max. Cycles at Max. Process Temperature	1
Process Temperature max. C	260

Material Info

Reference - Drawing Numbers

Product Specification	PS-44300-001, RPS-44300-001
Sales Drawing	SD-44428-001

This document was generated on 06/03/2013

PLEASE CHECK WWW.MOLEX.COM FOR LATEST PART INFORMATION