

Circuit Breaker for Equipment thermal, THT terminals for PCB mounting horizontal, 1 pole

new



### Approvals and Compliances

#### Description

- Thermal circuit breaker
- 1-pole
- On request available with elevated glow-wire ratings
- THT connectors

#### Unique Selling Proposition

- Reset type
- Cycling trip-free release
- Compact design
- Different mounting possibilities

#### Applications

- Power supplies
- Uninterruptible power supply
- Power tools
- Industrial appliances
- HVAC
- Household appliances

#### Weblinks

[pdf datasheet](#), [html-datasheet](#), [General Product Information](#), [Distributor-Stock-Check](#), [Detailed request for product](#), [Product News](#), [Video](#)

#### Technical Data

Rated Voltage AC	240 V, 50 / 60 Hz
Rated Voltage DC	48 / 32 V, see approvals
Rated current	3-15 A, see approbations
Conditional short circuit capacity	IEC: Inc, PC1, AC 240 V: 2 kA UL / CSA: SC, AC 240 V DC 48 / 32 V: 2 kA, C1
Degree of protection front side	IP 40
Endurance minimum	IEC: 200% I <sub>r</sub> , cos φ 0.6: min. 50 switching cycles
Endurance typical	3-8 A: 150% I <sub>r</sub> , cos φ 0.9: 2500 switching cycles 10-15 A: 150% I <sub>r</sub> , cos φ 0.9: 6000 switching cycles
Dielectric Strength	1500 VAC
Insulation Resistance	500 VDC > 1000 MΩ

Ambient temperature	3 A: -5 °C to 60 °C 4 A: -5°C to 50 °C 5-15 A: -5 °C to 60 °C
Soldering Methods	Wave
Solderability	245 °C / 3 sec acc. to IEC 60068-2-20 / Test Ta, method 1
Resistance to Soldering Heat	260 °C / 10 sec acc. to IEC 60068-2-20 / Test Tb, method 1A
Weight	approx. 12.5 g

### Approvals and Compliances

Detailed information on product approvals, code requirements, usage instructions and detailed test conditions can be looked up in [Details about Approvals](#)

#### Approvals

The approval mark is used by the testing authorities to certify compliance with the safety requirements placed on electronic products.

Approval Reference Type: T9

Approval Logo	Certificates	Certification Body	Description
	<a href="#">VDE Approvals</a>	VDE	VDE Certificate Number:
	<a href="#">UL Approvals</a>	UL	UL File Number:
	<a href="#">CQC Approvals</a>	CQC	CCC File Number:





## Application standards

Application standards where the product can be used

Organization	Design	Standard	Description
	Designed for applications acc.	IEC/UL 60950	IEC 60950-1 includes the basic requirements for the safety of information technology equipment.

## Compliances

The product complies with following Guide Lines

Identification	Details	Initiator	Description
	<a href="#">CE declaration of conformity</a>	SCHURTER AG	The CE marking declares that the product complies with the applicable requirements laid down in the harmonisation of Community legislation on its affixing in accordance with EU Regulation 765/2008.
	RoHS	SCHURTER AG	EU Directive RoHS 2011/65/EU
	China RoHS	SCHURTER AG	The law SJ / T 11363-2006 (China RoHS) has been in force since 1 March 2007. It is similar to the EU directive RoHS.
	REACH	SCHURTER AG	On 1 June 2007, Regulation (EC) No 1907/2006 on the Registration, Evaluation, Authorization and Restriction of Chemicals 1 (abbreviated as "REACH") entered into force.

## Dimension [mm]

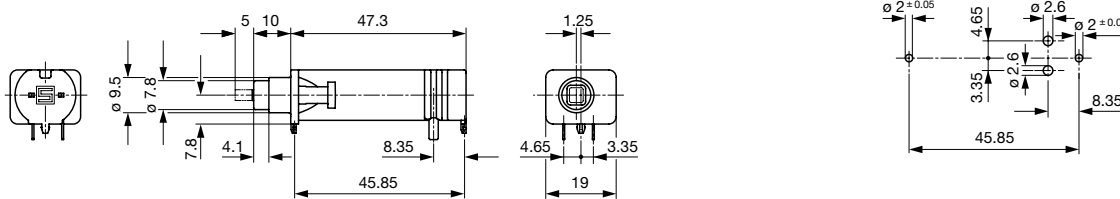



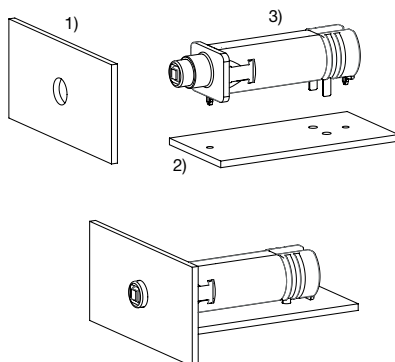

Drilling diagram

## Assembly Instructions



- 1) Front panel
- 2) PCB
- 3) T9-818

Approval		Rated current	Rated voltage AC	Rated voltage DC
	UL 1077	3 - 12 A 14 - 15 A	240 V 240 V	48 V 32 V
	CSA 22.2 235	3 - 12 A 14 - 15 A	240 V 240 V	48 V 32 V
	IEC 60934	3 - 12 A 14 - 15 A	240 V 240 V	48 V 32 V
	GB 17701	3 - 12 A 14 - 15 A	240 V 240 V	48 V 32 V

**Typical internal resistance**

Rated Current [A]	Internal Resistance [mΩ]
3	80.0
4	26.3
5	24.1
6	19.0
7	18.0
8	14.8
10	13.0
12	12.7
14	9.7
15	8.0

**Time-Current-Curves**

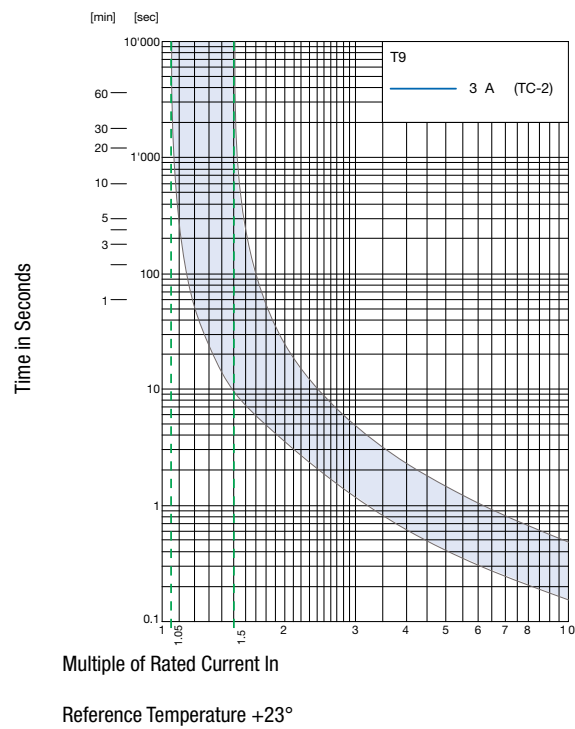
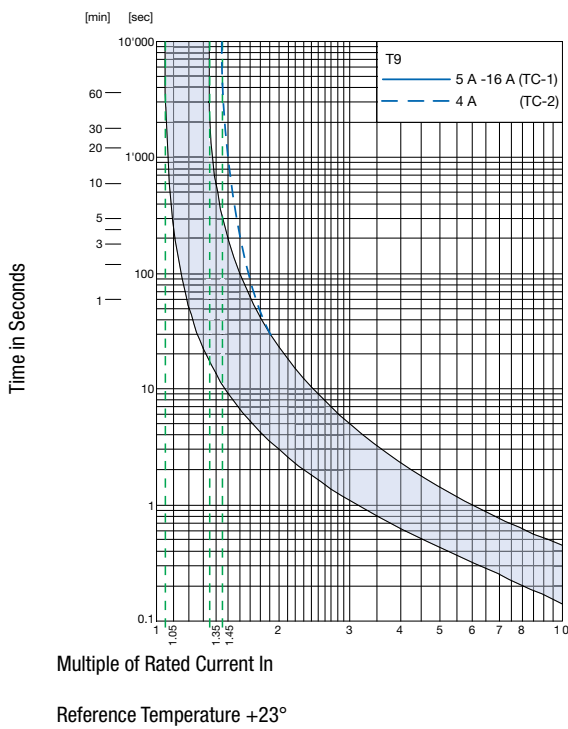

**Effect of ambient temperature**

The units are calibrated for an ambient temperature of +23°C. To determine the rated current for a lower or higher ambient temperature, use a correction factor (typical value) from the table below:

Ambient temperature [°C]	Correction factor
-5	0,85
+10	0,95
+23	1,00
+40	1,08
+60	1,21

Example: Rated current = 10 A; Environmental temperature = 60 °C; --> Correction factor = 1.21; Resulting current = 12.1 A --> Fount to next higher rated current: 13 A

## Variants

connection type	Rated current	Order Number
Solder, THT	3A	4404.0096
Solder, THT	4A	4404.0097
Solder, THT	5A	4404.0098
Solder, THT	6A	4404.0099
Solder, THT	7A	4404.0100
Solder, THT	8A	4404.0101
Solder, THT	10A	4404.0102
Solder, THT	12A	4404.0103
Solder, THT	14A	4404.0104
Solder, THT	15A	4404.0105

Most Popular.

Availability for all products can be searched real-time: <https://www.schurter.com/en/Stock-Check/Stock-Check-SCHURTER>

**Packaging Unit** 100 Pcs