

PLEASE CHECK WWW.MOLEX.COM FOR LATEST PART INFORMATION

Part Number: [43860-0005](#)
Status: **Active**
Overview: [Modular Plugs - Jacks](#)
Description: Modular Jack, Right Angle, Low Profile, Inverted, Shielded, All Panel Grounding Tabs, 6/6

Documents:

3D Model	Application Specification AS-43860-001 (PDF)
Drawing (PDF)	Test Summary TS-43860-001 (PDF)
Product Specification PS-43860-003 (PDF)	RoHS Certificate of Compliance (PDF)

Agency Certification

CSA	LR19980
UL	E107635

General

Product Family	Modular Jacks/Plugs
Series	43860
Component Type	PCB Jack
Magnetic	No
Overview	Modular Plugs - Jacks
Performance Category	3
Power over Ethernet (PoE)	N/A
Product Name	RJ11
UPC	800753918009

Physical

Boot Color	N/A
Color - Resin	Black
Durability (mating cycles max)	500
Flammability	94V-0
Inverted / Top Latch	Yes
Jack Height	13.53mm
Lightpipes/LEDs	None
Material - Metal	Brass, Phosphor Bronze
Material - Plating Mating	Gold
Material - Plating Termination	Tin
Material - Resin	High Temperature Thermoplastic
Net Weight	3.732/g
Orientation	Right Angle (Side Entry)
PCB Locator	Yes
PCB Retention	Yes
PCB Thickness - Recommended	1.60mm
Packaging Type	Tray
Panel Mount	With Flange
Pitch - Mating Interface	1.02mm
Pitch - Termination Interface	1.02mm
Plating min - Mating	1.270µm
Plating min - Termination	2.540µm
Ports	1
Positions / Loaded Contacts	6/6
Surface Mount Compatible (SMC)	No
Temperature Range - Operating	-40°C to +85°C
Termination Interface: Style	Through Hole
Waterproof / Dustproof	No
Wire/Cable Type	N/A

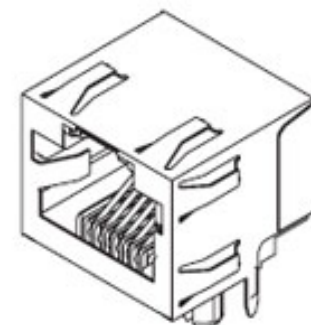

image - Reference only

Series

EU RoHS

**ELV and RoHS
Compliant**

REACH SVHC

**Contains SVHC: No
Low-Halogen Status
Not Low-Halogen**

China RoHS



**Need more information on product
environmental compliance?**

Email productcompliance@molex.com
 For a multiple part number RoHS Certificate of Compliance, [click here](#)

Please visit the [Contact Us](#) section for any non-product compliance questions.

Search Parts in this Series

[43860Series](#)

Mates With

[FCC 68 Plugs](#)

Electrical

Current - Maximum per Contact	1.5A
Grounding to PCB	Yes
Grounding to Panel	Yes
Shielded	Yes
Voltage - Maximum	150V AC (RMS)

Solder Process Data

Duration at Max. Process Temperature (seconds)	5
Lead-free Process Capability	Wave Capable (TH only)
Max. Cycles at Max. Process Temperature	1
Process Temperature max. C	260

Material Info**Reference - Drawing Numbers**

Application Specification	AS-43860-001
Product Specification	PS-43860-003, RPS-43860-004, RPS-43860-007, RPS-43860-008, RPS-43860-013
Sales Drawing	SD-43860-001
Test Summary	TS-43860-001

This document was generated on 01/22/2013

PLEASE CHECK WWW.MOLEX.COM FOR LATEST PART INFORMATION