

PLEASE CHECK WWW.MOLEX.COM FOR LATEST PART INFORMATION

Part Number: [43045-1401](#)
Status: **Active**
Overview: Micro-Fit 3.0™ Connectors
Description: 3.00mm Pitch Micro-Fit 3.0™ Header, Surface Mount Compatible, Dual Row, Right Angle, with Snap-in Plastic Peg PCB Lock, 14 Circuits, 0.38µm Gold (Au) Selective Plating, Glow Wire Compatible

Documents:

3D Model	Test Summary TS-43045-002 (PDF)
Drawing (PDF)	RoHS Certificate of Compliance (PDF)
Product Specification PS-43045 (PDF)	Product Literature (PDF)
Test Summary TS-43045-001 (PDF)	

Agency Certification

CSA	LR19980
TUV	R72081037
UL	E29179

General

Product Family	PCB Headers
Series	43045
Application	Power, Wire-to-Board
Comments	"High Temperature Square Pin Solder Type<P><P>This Molex product is manufactured from material that has the following ratings, tested by independent agencies: a) A Glow Wire Ignition Temperature (GWIT) of at least 775 deg C per IEC 60695-2-13.. b) A Glow Wire Flammability Index (GWFI) above 850 deg C per IEC 60695-2-12.and hence complies with the requirements set out in the International Standard IEC 60335-1 5th edition - household and similar electrical appliances - safety, section 30 Resistance to heat and fire. <P><P> The customers using this product must determine its suitability for use in their particular application through testing or other acceptable means as described in end-product glow-wire flammability test standard IEC 60695-2-11 and any applicable product end-use standard(s). <P> If it is determined during the customer's evaluation of suitability, that higher performance is required, please contact Molex for possible product options." <u>Micro-Fit 3.0™ Connectors</u>
Overview	<u>Micro-Fit 3.0™ Connectors</u>
Product Literature Order No	987650-5984
Product Name	Micro-Fit 3.0™
UPC	800754373425

Physical

Breakaway	No
Circuits (Loaded)	14
Circuits (maximum)	14
Color - Resin	Black
Durability (mating cycles max)	30
Flammability	94V-0
Glow-Wire Compliant	Yes
Mated Height	10.29mm
Material - Metal	Brass

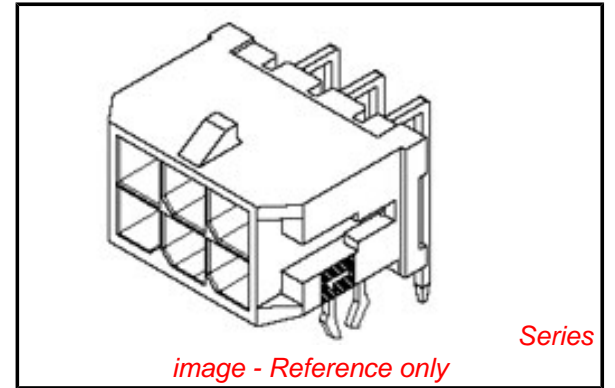

EU RoHS

ELV and RoHS Compliant
REACH SVHC Contains SVHC: No
Low-Halogen Status Low-Halogen

China RoHS



Need more information on product environmental compliance?

Email productcompliance@molex.com
For a multiple part number RoHS Certificate of Compliance, [click here](#)

Please visit the [Contact Us](#) section for any non-product compliance questions.

Search Parts in this Series

[43045Series](#)

Mates With

[43025](#)

Material - Plating Mating	Gold
Material - Plating Termination	Tin
Material - Resin	High Temperature Thermoplastic
Net Weight	2.231/g
Number of Rows	2
Orientation	Right Angle
PCB Locator	Yes
PCB Retention	Yes
PCB Thickness - Recommended	1.60mm
Packaging Type	Tray
Pitch - Mating Interface	3.00mm
Plating min - Mating	0.381µm
Plating min - Termination	2.540µm
Polarized to PCB	Yes
Shrouded	Fully
Stackable	No
Surface Mount Compatible (SMC)	Yes
Temperature Range - Operating	-40°C to +105°C
Termination Interface: Style	Through Hole

Electrical

Current - Maximum per Contact	5A
Voltage - Maximum	250V

Solder Process Data

Duration at Max. Process Temperature (seconds)	30
Lead-free Process Capability	SMC & Wave Capable (TH only)
Max. Cycles at Max. Process Temperature	3
Process Temperature max. C	260

Material Info

Reference - Drawing Numbers

Product Specification	PS-43045, RPS-43045-003, RPS-43045-004
Sales Drawing	SD-43045-001
Test Summary	TS-43045-001, TS-43045-002

This document was generated on 12/17/2012

PLEASE CHECK WWW.MOLEX.COM FOR LATEST PART INFORMATION