

IEC Appliance Inlet C14 with Fuseholder 1- or 2-pole and Voltage Selector

Standard or Medical Fuse drawer



V-Lock



Fuse drawer must be ordered separately (see accessories).

Fuse drawer must be ordered separately (see accessories).



Description

- Panel Mount:
Screw-on version from front or rear side, snap-in version from front side
- 3 Functions:
Appliance Inlet Protection class I, Fuseholder with interchangeable fuse drawer for Fuse-links 5x20 mm or 6.3x32 mm 1- or 2-pole, with or without voltage selector (step switch)
- Quick connect terminals 4.8 x 0.8 mm

Approvals

- VDE Certificate Number: 40030345
- UL File Number: E93617
- CSA File Number: 38456
- CCC File Number: 2010010204409773

Characteristics

- Available with or without internal connections
- The fuse drawer "Fingergrip" can be removed by hand
For added safety "Extra-Safe" fuse drawers are available
Fuse drawer meets requirements of medical standard IEC/EN 60601-1
The fuse drawer can only be opened with the aid of a tool
The fuseholder is accessible from the equipment front
- Suitable for use in equipment according to IEC/UL 60950

Other versions on request

- Fuse drawer with other voltage values
- For protection class II
- Variant with notch for V-Lock mating Cordsets

References

Alternative: version with line filter [KFC](#)

Weblinks

[pdf-datasheet](#), [html-datasheet](#), [General Product Information](#), [Approvals](#), [CE declaration of conformity](#), [RoHS](#), [CHINA-RoHS](#), [REACH](#), [Mating Connectors](#), [e-Shop](#), [SCHURTER-Stock-Check](#), [Distributor-Stock-Check](#), [CAD-Drawings](#), [Accessories](#), [Detailed request for product](#)

Newly available variants corresponding to V-Lock mating cordset. The connector is equipped with a notch intended for use with the latching cordset. The cord latching system prevents against accidental removal of the cordset.

Technical Data

Ratings IEC	10A / 250VAC; 50Hz	Appliance Inlet	C14 acc. to IEC 60320, UL 498, CSA C22.2 no. 42 (for cold conditions) pin-temperature 70 °C, 10A, Protection Class I
Ratings UL/CSA	13A / 125VAC; 60Hz ¹⁾	Fuseholder	1 or 2 pole, Shocksafe category PC2 acc. to IEC 60127-6, for fuse-links 5 x 20 or 6.3 x 32 mm
Dielectric Strength	> 3kVAC between L-N > 4kVAC between L/N-PE (1 min/50Hz)	Rated Power Acceptance @ Ta 23 °C	5 x 20: 2.5W (1 pole)/ 2W (2-pole) per pole 6.3 x 32: 3.15W (1 pole)/ 2.5W (2-pole) per pole
Allowable Operation Temp.	-25 °C to 70 °C	Power Acceptance @ Ta > 23°C	Admissible power acceptance at higher ambient temperature see derating curves
Degree of Protection	from front side IP 40 acc. to IEC 60529	Voltage Selector	optional, step, 2-4 digits
Protection Class	Suitable for appliances with protection class I acc. to IEC 61140		
Terminal	Quick connect terminals 4.8 x 0.8 mm		
Panel Thickness s	Screw: max 8 mm Mounting screw torque max 0.5Nm Snap-in: 1.5/2/2.5 mm		
Material: Housing	Thermoplastic, black, UL 94V-0		

Dimensions

Screw-on mounting

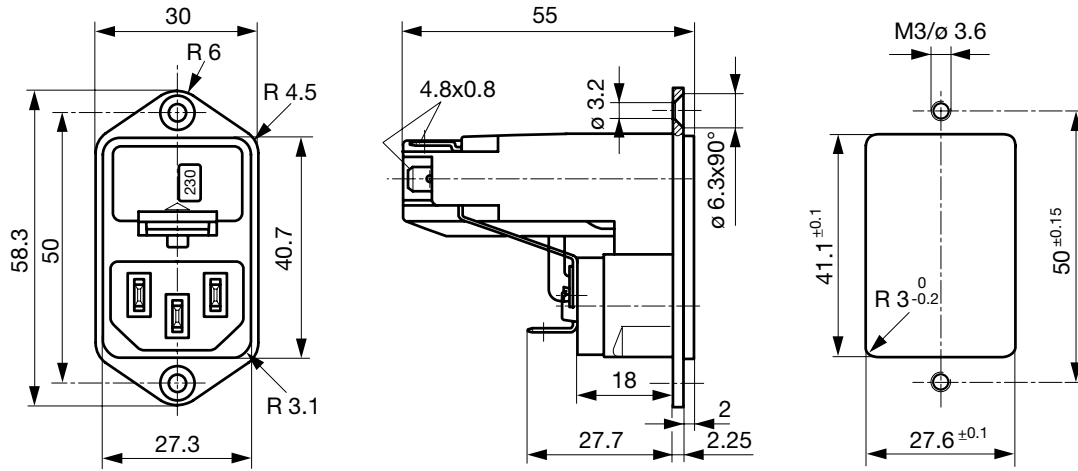

Snap-in mounting

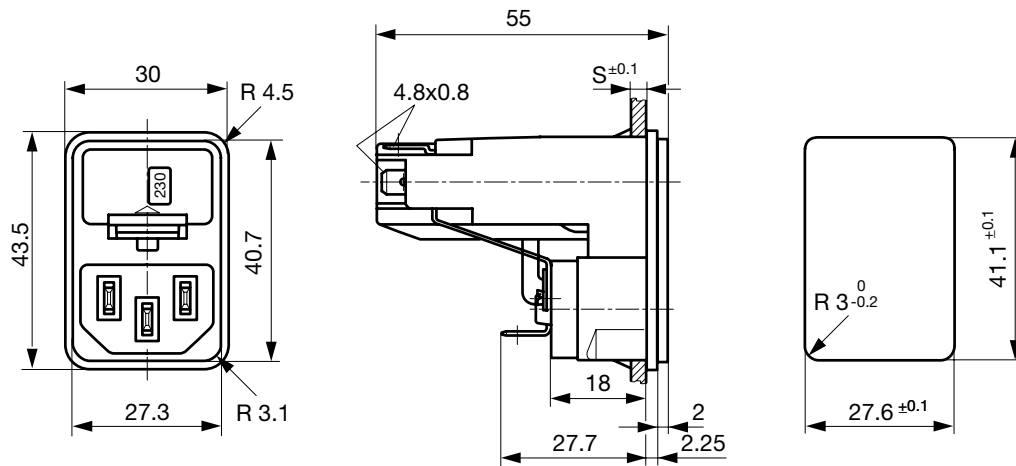

Diagrams

without internal connections
Voltage selector
4-positions, 1-pole

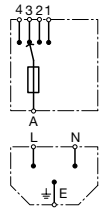

without internal connections
Voltage selector
4-positions, 2-pole

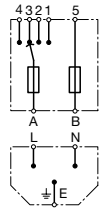

with internal connections
Voltage selector
4-positions, 1-pole

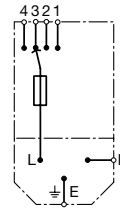

with internal connections
Voltage selector
4-positions, 2-pole

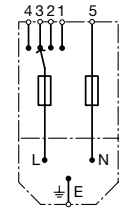

Voltage selector
3-positions
1-pole

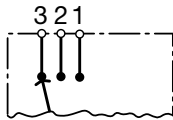

Voltage selector
3-positions
2-pole

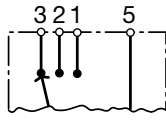

Voltage selector
2-positions
1-pole

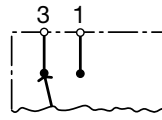

Voltage selector
2-positions
2-pole

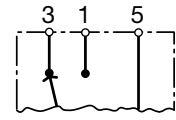

without voltage selector
1-pole

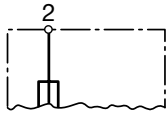

without voltage selector
2-pole

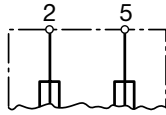

Derating Curves

Fuses
5 x 20 mm (1-pole)

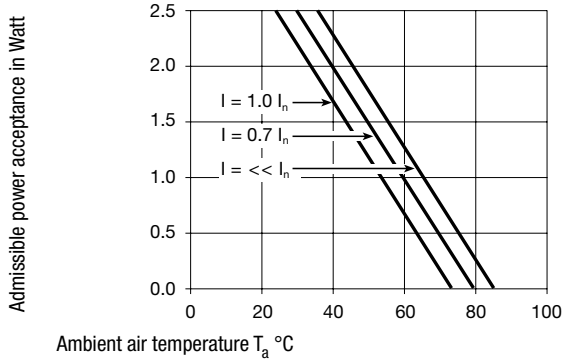

Fuses
5 x 20 mm (2-pole, per pole)

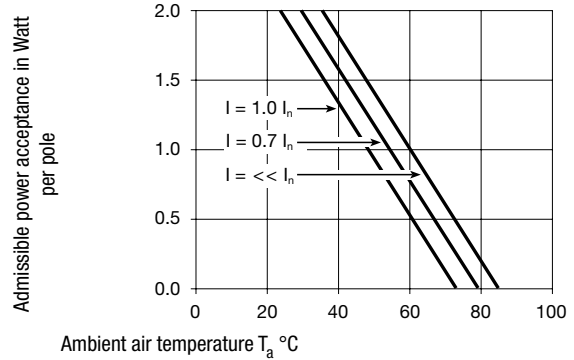

Fuses
6.3 x 32 mm (1-pole)

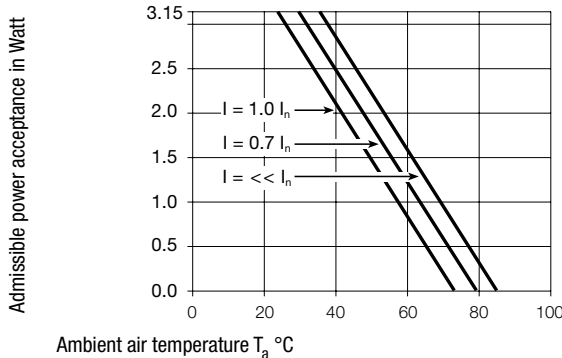

Fuses
6.3 x 32 mm (2-pole, per pole)

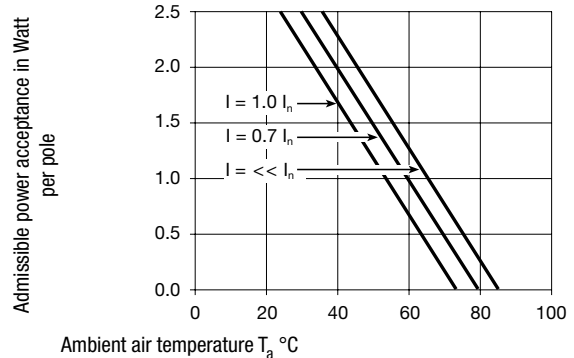

All Variants

Panel mounting	Panel Thickness s [mm]	Fuseholder	Voltage Selector	Internally wired	Order Number
Snap-in	1.5	1-pole	-	●	4303.0032
Snap-in	1.5	1-pole	3/4 digits	●	4303.0092
Snap-in	1.5	1-pole	2 pos.	●	4303.0212
Snap-in	2	1-pole	-	●	4303.0033
Snap-in	2	1-pole	3/4 digits	●	4303.0093
Snap-in	2	1-pole	2 pos.	●	4303.0213
Snap-in	2.5	1-pole	-	●	4303.0034
Snap-in	2.5	1-pole	3/4 digits	●	4303.0094
Snap-in	2.5	1-pole	2 pos.	●	4303.0214
Snap-in	1.5	1-pole	-		4303.1032
Snap-in	1.5	1-pole	3/4 digits		4303.1092
Snap-in	1.5	1-pole	2 pos.		4303.1212
Snap-in	2	1-pole	-		4303.1033
Snap-in	2	1-pole	3/4 digits		4303.1093
Snap-in	2	1-pole	2 pos.		4303.1213
Snap-in	2.5	1-pole	-		4303.1034
Snap-in	2.5	1-pole	3/4 digits		4303.1094
Snap-in	2.5	1-pole	2 pos.		4303.1214
Snap-in	1.5	2-pole	-	●	4303.0002
Snap-in	1.5	2-pole	3/4 digits	●	4303.0062
Snap-in	1.5	2-pole	2 pos.	●	4303.0182
Snap-in	2	2-pole	-	●	4303.0003
Snap-in	2	2-pole	3/4 digits	●	4303.0063
Snap-in	2	2-pole	2 pos.	●	4303.0183
Snap-in	2.5	2-pole	-	●	4303.0004
Snap-in	2.5	2-pole	3/4 digits	●	4303.0064
Snap-in	2.5	2-pole	2 pos.	●	4303.0184
Snap-in	1.5	2-pole	-		4303.1002
Snap-in	1.5	2-pole	3/4 digits		4303.1062
Snap-in	1.5	2-pole	2 pos.		4303.1182
Snap-in	2	2-pole	-		4303.1003
Snap-in	2	2-pole	3/4 digits		4303.1063
Snap-in	2	2-pole	2 pos.		4303.1183
Snap-in	2.5	2-pole	-		4303.1004
Snap-in	2.5	2-pole	3/4 digits		4303.1064
Snap-in	2.5	2-pole	2 pos.		4303.1184
Screw	-	1-pole	-	●	4303.0031
Screw	-	1-pole	3/4 digits	●	4303.0091
Screw	-	1-pole	2 pos.	●	4303.0211
Screw	-	1-pole	-		4303.1031
Screw	-	1-pole	3/4 digits		4303.1091
Screw	-	1-pole	2 pos.		4303.1211
Screw	-	2-pole	-	●	4303.0001
Screw	-	2-pole	3/4 digits	●	4303.0061
Screw	-	2-pole	2 pos.	●	4303.0181
Screw	-	2-pole	-		4303.1001
Screw	-	2-pole	3/4 digits		4303.1061
Screw	-	2-pole	2 pos.		4303.1181

Most Popular.

Availability for all products can be searched real-time: <http://www.schurter.com/en/Stock-Check/Stock-Check-SCHURTER>

Suffix ".21" corresponds to the version with V-Lock mating cordset. The connector is equipped with a notch intended for use with the latching cordset. The cord latching system prevents against accidental removal of the cordset.

Packaging unit 50 Pcs

Required Accessory

Description



Fusedrawer 3
Fusedrawer for Fuse Links 5x20 mm resp. 6.3x32 mm

Accessories

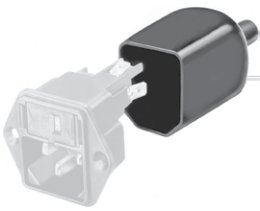

Assorted Covers
Rear Cover



Cord retaining kits
Cord retaining strain relief

Mating Outlets/Connectors

Category / Description



[Appliance Outlet Overview complete](#)

IEC Appliance Outlet F, Screw-on Mounting, Front Side, Solder Terminal	4787
IEC Appliance Outlet F, Snap-in Mounting, Front Side, Solder or Quick-connect Terminal	4788
IEC Appliance Outlet F or H, Screw-on Mounting, Front Side, Solder, PCB or Quick-connect Terminal	5091

[Appliance Outlet further types to KEC](#)

[Connector Overview complete](#)



IEC Connector C15A, Rewireable, Straight	0102
IEC Connector C15A, Rewireable, Straight	0102-G
IEC Connector C15A, Rewireable, Angled	0112
IEC Connector C13, Rewireable, Angled	4012
IEC Connector C13, Rewireable, Straight	4022

[Connector further types to KEC](#)

...

Mating Outlets/Connectors shuttered



[Power Cord Overview complete](#)

[Overview Power Supply Cord with IEC Connector C13, V-Lock, straight](#)

[VAC13KS](#)

[Power Cord further types to KEC](#)