

# 42KEPS10BBSW ✓ ACTIVE

Corcom KEP

TE Internal #: 6-1609968-2

3-Phase Filters, 42A Current Rating, Terminal Block Input, Terminal Block Output, WYE (4 wire + ground), Operating Voltage 520 VAC, Corcom KEP

[View on TE.com >](#)



EMI & EMC Solutions > EMI Filters > Power Line Filters > 3-Phase Filters



Current Rating: **42 A**

Input Termination Type: **Terminal Block**

Output Termination Type: **Terminal Block**

Wiring Configuration: **WYE (4 wire + ground)**

Operating Voltage: **520 VAC**

## Features

### Product Type Features

Filtering Requirements	Filtered
Input Termination Type	Terminal Block
Output Termination Type	Terminal Block

### Configuration Features

Wiring Configuration	WYE (4 wire + ground)
----------------------	-----------------------

### Electrical Characteristics

Leakage Current (Max) (230VAC, 50Hz)	6
Current Rating	42 A
Operating Voltage	520 VAC

### Mechanical Attachment

Product Mount Type	Chassis
--------------------	---------

### Usage Conditions

Operating Temperature Range	-25 – 85 °C
-----------------------------	-------------

## Product Compliance

[For compliance documentation, visit the product page on TE.com>](#)

EU RoHS Directive 2011/65/EU	Compliant with Exemptions
EU ELV Directive 2000/53/EC	Not Compliant
China RoHS 2 Directive MIIT Order No 32, 2016	Restricted Materials Above Threshold
EU REACH Regulation (EC) No. 1907/2006	<p>Current ECHA Candidate List: JUNE 2024 (241)</p> <p>Candidate List Declared Against: JUNE 2024 (241)</p> <p>SVHC &gt; Threshold: Pb (3% in Component Part)</p> <p><b>Article Safe Usage Statements:</b> Do not eat, drink or smoke when using this product. Wash thoroughly after handling. Recycle if possible and dispose of the article by following all applicable governmental regulations relevant to your geographic location.</p>
Halogen Content	Not Low Halogen - contains Br or Cl > 900 ppm.
Solder Process Capability	Not reviewed for solder process capability

### Product Compliance Disclaimer

This information is provided based on reasonable inquiry of our suppliers and represents our current actual knowledge based on the information they provided. This information is subject to change. The part numbers that TE has identified as EU RoHS compliant have a maximum concentration of 0.1% by weight in homogenous materials for lead, hexavalent chromium, mercury, PBB, PBDE, DBP, BBP, DEHP, DIBP, and 0.01% for cadmium, or qualify for an exemption to these limits as defined in the Annexes of Directive 2011/65/EU (RoHS2). Finished electrical and electronic equipment products will be CE marked as required by Directive 2011/65/EU. Components may not be CE marked. Additionally, the part numbers that TE has identified as EU ELV compliant have a maximum concentration of 0.1% by weight in homogenous materials for lead, hexavalent chromium, and mercury, and 0.01% for cadmium, or qualify for an exemption to these limits as defined in the Annexes of Directive 2000/53/EC (ELV). Regarding the REACH Regulation, the information TE provides on SVHC in articles for this part number is based on the latest European Chemicals Agency (ECHA) 'Guidance on requirements for substances in articles' posted at this URL: <https://echa.europa.eu/guidance-documents/guidance-on-reach>

## Compatible Parts



Also in the Series | [Corcom KEP](#)



3-Phase Filters(48)

## Customers Also Bought

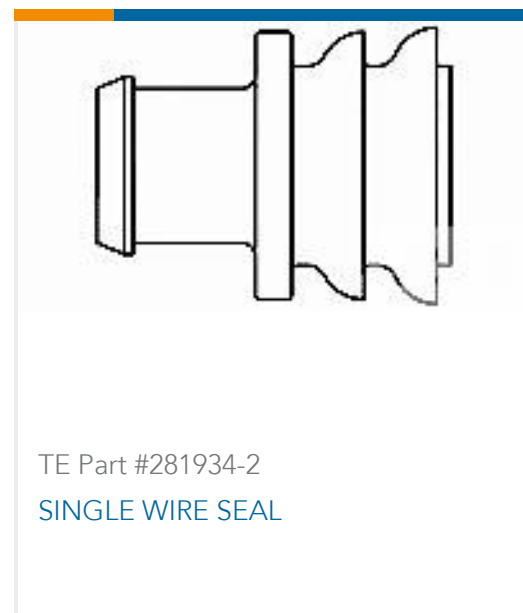
TE Part #DT04-2P  
REC, 2P, GRY, NTE Part #DT06-2S  
PLG, 2P, GRY, NTE Part #W2S  
Wedgelocks: DEUTSCH DTTE Part #0460-202-16141  
DEUTSCH Solid ContactsTE Part #282104-1  
AMP SUPERSEAL 1.5MM,  
CONNECTOR HOUSINGTE Part #281934-2  
SINGLE WIRE SEALTE Part #114017-ZZ  
SEALING PLUG, SIZE 12/16, WHT

## Documents

### Product Drawings

[KEP 42A 1S HIGH PLUS SP BS WYE 520VAC](#)

English

### CAD Files

Customer View Model

[ENG\\_CVM\\_CVM\\_6-1609968-2\\_B.2d\\_dxf.zip](#)

English

Customer View Model

[ENG\\_CVM\\_CVM\\_6-1609968-2\\_B.3d\\_stp.zip](#)

English

Customer View Model

[ENG\\_CVM\\_CVM\\_6-1609968-2\\_B.3d\\_igs.zip](#)

English

### 3D PDF

3D

By downloading the CAD file I accept and agree to the [Terms and Conditions](#) of use.



---

[Datasheets & Catalog Pages](#)

[KEP-BS SERIES](#)

English