

PLEASE CHECK WWW.MOLEX.COM FOR LATEST PART INFORMATION

Part Number: [42819-4223](#)
Status: **Active**
Overview: [Mini-Fit Sr.™](#)
Description: 10.00mm Pitch Mini-Fit Sr.™ Header, Single Row, Vertical, 4 Circuits, 2.36mm PCB Thickness, 0.76µm Gold (Au) Selective Plating

Documents:

[3D Model](#) [RoHS Certificate of Compliance \(PDF\)](#)
[Drawing \(PDF\)](#)

Agency Certification

CSA	LR19980
TUV	R72081037
UL	E29179

General

Product Family	PCB Headers
Series	42819
Application	Power, Wire-to-Board
Overview	Mini-Fit Sr.™
Product Name	Mini-Fit Sr.™
UPC	800756513508

Physical

Breakaway	No
Circuits (Loaded)	4
Circuits (maximum)	4
Color - Resin	Black
Durability (mating cycles max)	100
First Mate / Last Break	No
Flammability	94V-0
Glow-Wire Compliant	No
Guide to Mating Part	No
Keying to Mating Part	None
Lock to Mating Part	Yes
Material - Metal	Brass
Material - Plating Mating	Gold
Material - Plating Termination	Tin
Material - Resin	High Temperature Thermoplastic
Net Weight	9.760/g
Number of Rows	1
Orientation	Vertical
PC Tail Length	5.10mm
PCB Locator	Yes
PCB Retention	Yes
PCB Thickness - Recommended	2.40mm
Packaging Type	Tray
Pitch - Mating Interface	10.00mm
Pitch - Termination Interface	10.00mm
Plating min - Mating	0.762µm
Plating min - Termination	2.540µm
Polarized to Mating Part	Yes
Polarized to PCB	Yes
Shrouded	Fully
Stackable	No
Surface Mount Compatible (SMC)	No

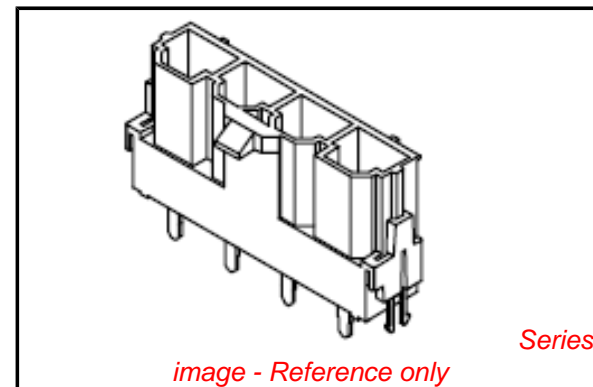

EU RoHS

ELV and RoHS Compliant
REACH SVHC
Contains SVHC: No
Low-Halogen Status
Not Low-Halogen

China RoHS



Need more information on product environmental compliance?

Email productcompliance@molex.com
 For a multiple part number RoHS Certificate of Compliance, [click here](#)

Please visit the [Contact Us](#) section for any non-product compliance questions.

Search Parts in this Series

[42819Series](#)

Mates With

Mini-Fit Sr.™ Receptacle Housing with TPA
[42816](#)

Temperature Range - Operating -40°C to +105°C
Termination Interface: Style Through Hole

Electrical

Current - Maximum per Contact 50A
Voltage - Maximum 600V

Solder Process Data

Duration at Max. Process Temperature (seconds) 3
Lead-free Process Capability Wave Capable (TH only)
Max. Cycles at Max. Process Temperature 1
Process Temperature max. C 265

Material Info

Reference - Drawing Numbers

Product Specification RPS-42815-011, RPS-42815-012, RPS-42815-013,
RPS-42815-014
Sales Drawing SDA-42819-0002

This document was generated on 01/22/2013

PLEASE CHECK WWW.MOLEX.COM FOR LATEST PART INFORMATION