



MTA 100

TE Internal #: 4-641190-4

Standard Rectangular Connectors, Connector Assembly, Receptacle, Mating Retention, Insulation Displacement (IDC), Wire-to-Board, MTA 100

[View on TE.com >](#)

Connectors > Rectangular Connectors > Standard Rectangular Connectors > Nylon Gold Plated Receptacle: 2.54 mm, no Mating Alignment



Connector Product Type: **Connector Assembly**

Connector & Housing Type: **Receptacle**

Mating Alignment: **Without**

Mating Retention: **With**

Mating Retention Type: **Locking Ramp**

[All Nylon Gold Plated Receptacle: 2.54 mm, no Mating Alignment \(89\)](#)

## Features

### Product Type Features

Compatible With Discrete Wire Type	Stranded
Connector Product Type	Connector Assembly
Connector & Housing Type	Receptacle
Connector System	Wire-to-Board
Insertion Force Type	Normal
Sealable	No
Connector & Contact Terminates To	Wire & Cable

### Configuration Features

Number of Cavities	14
Contacts Preloaded	Yes
Number of Positions	14
Number of Rows	1

### Electrical Characteristics

Operating Voltage	250 VAC
-------------------	---------

### Contact Features

Contact Type	Receptacle
Wire Contact Termination Area Plating Material	Tin



Contact Underplating Material	Nickel
Contact Mating Area Plating Material	Gold, Gold Flash over Palladium Nickel
Contact Retention Within Housing	With
Contact Current Rating (Max)	5 A

#### Termination Features

Termination Method to Wire & Cable	Insulation Displacement (IDC)
------------------------------------	-------------------------------

#### Mechanical Attachment

Contact Retention Type Within Housing	Locking Lance
Mating Alignment	Without
Mating Retention	With
Mating Retention Type	Locking Ramp
Connector Mounting Type	Cable Mount (Free-Hanging)

#### Housing Features

Housing Material	Nylon 6/6
Housing Color	Red
Centerline (Pitch)	2.54 mm[.1 in]

#### Dimensions

Connector Height	13.21 mm[.52 in]
Product Width	6.99 mm[.275 in]
Product Length	35.56 mm[1.4 in]
Wire Size	.3 – .4 mm <sup>2</sup>

#### Usage Conditions

Operating Temperature Range	-55 – 105 °C[-67 – 221 °F]
-----------------------------	----------------------------

#### Operation/Application

Shielded	No
Circuit Application	Signal

#### Industry Standards

CSA Rating	LR 7189
UL Rating	Recognized
Compatible With Agency/Standards Products	CSA, UL
Compatible With Approved Standards Products	UL E28476
UL Flammability Rating	UL 94V-2



### Packaging Features

Packaging Quantity	250
Packaging Method	Bag/Box

### Product Compliance

[For compliance documentation, visit the product page on TE.com>](#)

EU RoHS Directive 2011/65/EU	Compliant
EU ELV Directive 2000/53/EC	Compliant
China RoHS 2 Directive MIIT Order No 32, 2016	No Restricted Materials Above Threshold
EU REACH Regulation (EC) No. 1907/2006	Current ECHA Candidate List: JUNE 2024 (241) Candidate List Declared Against: JUNE 2023 (235) Does not contain REACH SVHC
Halogen Content	BFR/CFR/PVC Free, but Br/Cl >900 ppm in other sources.
Solder Process Capability	Not applicable for solder process capability

#### Product Compliance Disclaimer

This information is provided based on reasonable inquiry of our suppliers and represents our current actual knowledge based on the information they provided. This information is subject to change. The part numbers that TE has identified as EU RoHS compliant have a maximum concentration of 0.1% by weight in homogenous materials for lead, hexavalent chromium, mercury, PBB, PBDE, DBP, BBP, DEHP, DIBP, and 0.01% for cadmium, or qualify for an exemption to these limits as defined in the Annexes of Directive 2011/65/EU (RoHS2). Finished electrical and electronic equipment products will be CE marked as required by Directive 2011/65/EU. Components may not be CE marked. Additionally, the part numbers that TE has identified as EU ELV compliant have a maximum concentration of 0.1% by weight in homogenous materials for lead, hexavalent chromium, and mercury, and 0.01% for cadmium, or qualify for an exemption to these limits as defined in the Annexes of Directive 2000/53/EC (ELV). Regarding the REACH Regulation, the information TE provides on SVHC in articles for this part number is based on the latest European Chemicals Agency (ECHA) 'Guidance on requirements for substances in articles' posted at this URL: <https://echa.europa.eu/guidance-documents/guidance-on-reach>

### Compatible Parts

 <p>TE Part # 1-640550-4 14P MTA100 COVER</p>	 <p>TE Part # 58074-1 MTA 50/100/156 MANUAL TOOL FRAME</p>	 <p>TE Part # 58579-1 MTA 100 MANUAL TOOL ASSEMBLY DISCRETE</p>	 <p>TE Part # CAT-104MTA-NYLCC Nylon PCB Connector Covers: 2.54 mm, MTA 100</p>
--	---	--	--



TE Part # 4-641126-4  
14P MTA100 HDR ASY FL/STR LF



TE Part # 58246-3  
MTA 100 CRIMP HEAD PRODUCTION RBBN CABLE



TE Part # 58246-2  
MTA 100 CRIMP HEAD PRODUCTION DISCRETE

### Also in the Series | MTA 100



Connector Caps & Covers(69)

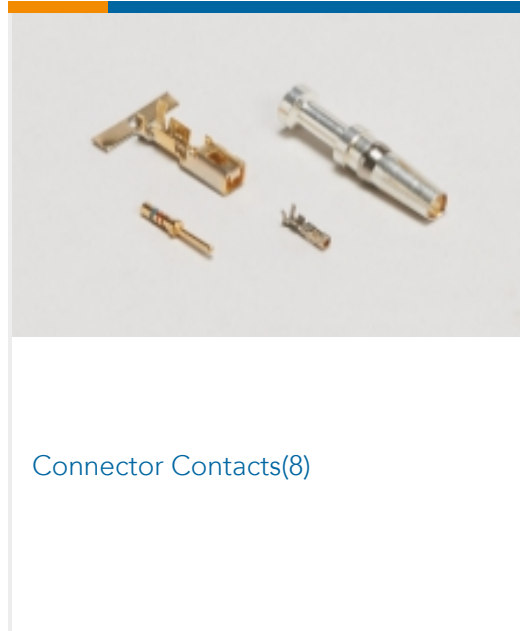

Connector Contacts(8)



Connector Hardware(1)

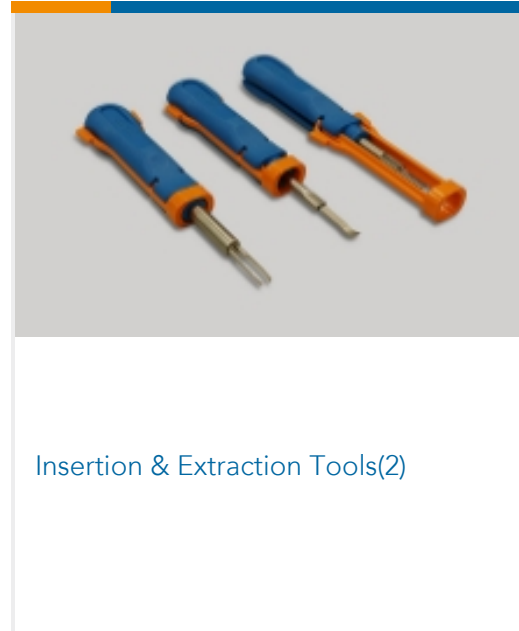

Insertion & Extraction Tools(2)



PCB Headers & Receptacles(440)

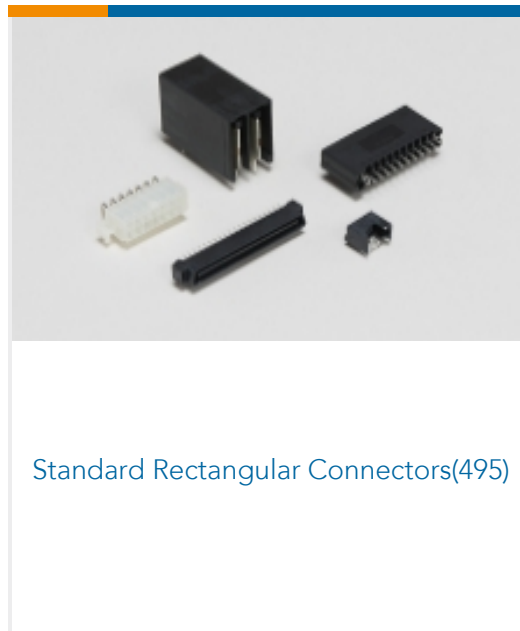

Standard Rectangular Connectors(495)

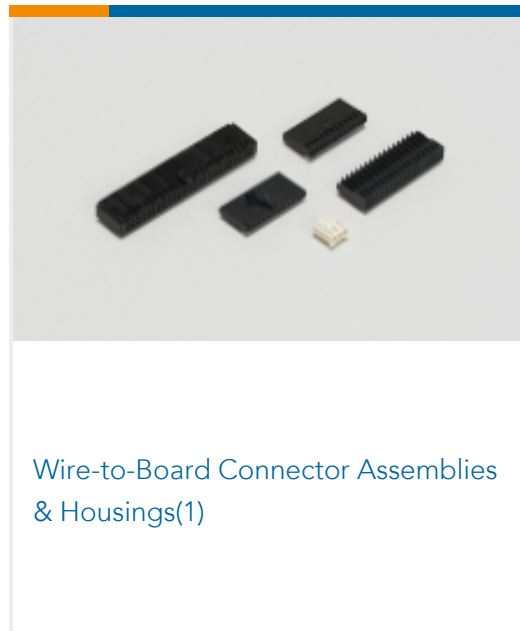

Wire-to-Board Connector Assemblies & Housings(1)

### Customers Also Bought

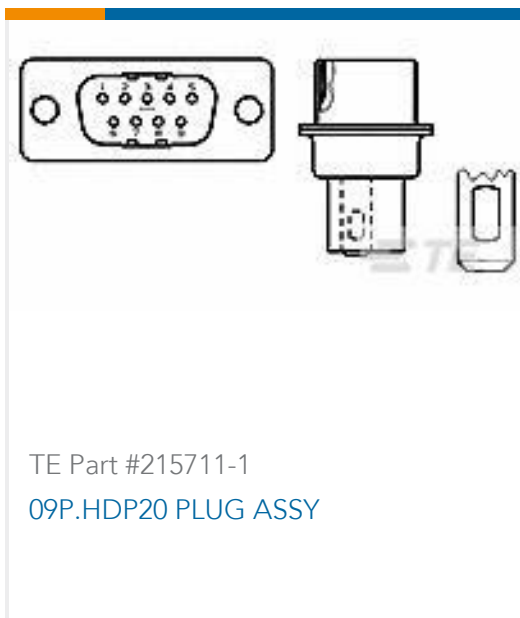

TE Part #215711-1  
09P.HDP20 PLUG ASSY



TE Part #9-160313-2  
PIDG FASTON Receptacle Quick Disconnects



TE Part #166293-1  
LP HD20 COSI PIN CONTACT DF; 24-20 AWG



TE Part #34155  
PG SPD 22-16 COMM 22-18 MIL 8

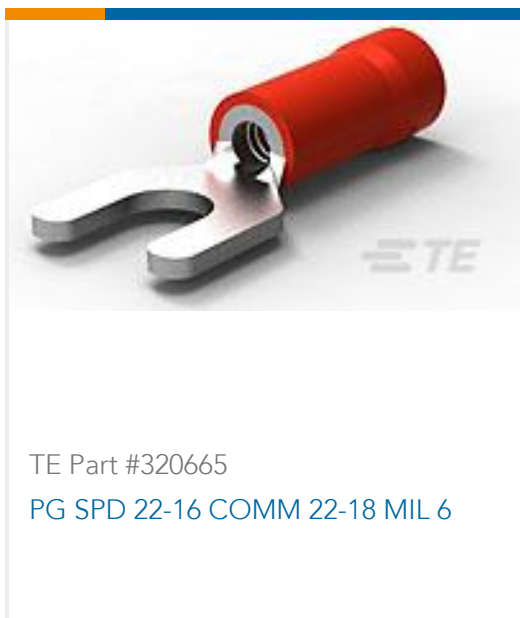

TE Part #320665  
PG SPD 22-16 COMM 22-18 MIL 6



TE Part #34142  
PG R 22-16 COMM 22-18 MIL 6



TE Part #165619-2  
110 PIDG FASTON REC

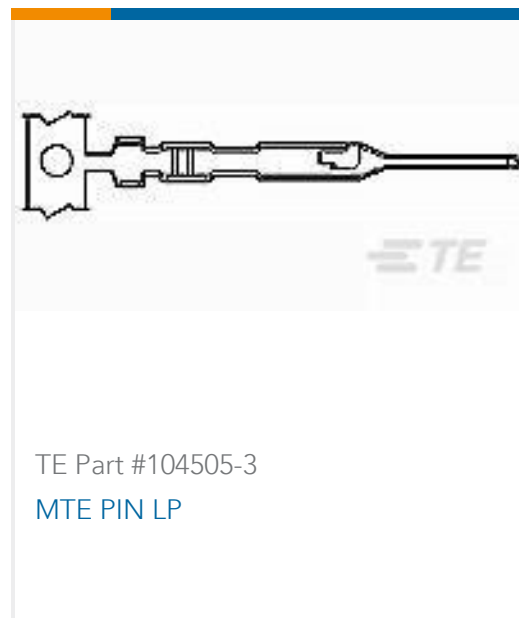

TE Part #104505-3  
MTE PIN LP



## Documents

### Product Drawings

[14P MTA100 CONN ASSY RED LF](#)

English

---

### CAD Files

[3D PDF](#)

3D

Customer View Model

[ENG\\_CVM\\_CVM\\_4-641190-4\\_S.2d\\_dxf.zip](#)

English

Customer View Model

[ENG\\_CVM\\_CVM\\_4-641190-4\\_S.3d\\_igs.zip](#)

English

Customer View Model

[ENG\\_CVM\\_CVM\\_4-641190-4\\_S.3d\\_stp.zip](#)

English

By downloading the CAD file I accept and agree to the [Terms and Conditions](#) of use.

---

### Product Specifications

[Application Specification](#)

English

---

### Agency Approvals

[Agency Approval Document](#)

English