

3-phase supply terminal for 3-phase busbar connection from top Size S00/S0

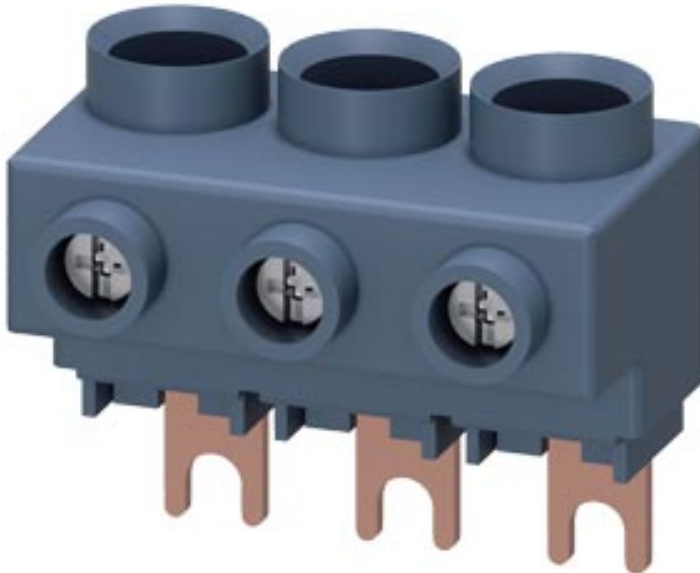





General technical data		
Product brand name		SIRIUS
Product designation		Three-phase feeder terminal
Design of the product		from above, size S0/S00
Size of the circuit-breaker		S00, S0
Protection class IP on the front		IP20
Insulation voltage with degree of pollution 3 at AC rated value	V	690
Ambient temperature		
• during storage	°C	-50 ... +80
• during operation	°C	-20 ... +60
Ampacity maximum	A	63
Installation/ mounting/ dimensions		
Width	mm	44.5
Height	mm	39
Depth	mm	27.2
Connections/ Terminals		
Type of electrical connection for main current circuit		screw-type terminals

Type of connectable conductor cross-sections	
<ul style="list-style-type: none"> • for main contacts <ul style="list-style-type: none"> — solid — stranded — finely stranded <ul style="list-style-type: none"> — with core end processing • at AWG conductors for main contacts 	<p>1x (2.5 ... 16 mm²)</p> <p>1x (2.5 ... 25 mm²)</p> <p>1x (2.5 ... 16 mm²)</p> <p>1x (10 ... 4)</p>

Certificates/ approvals



Certificate of suitability CE / UL / CSA / CCC

General Product Approval	Declaration of Conformity	Test Certificates
 CSA	 UL	 EAC
	 EG-Konf.	Miscellaneous
		Type Test Certificates/Test Report

Test Certificates	Shipping Approval
-------------------	-------------------

Special Test Certificate	 ABS	 BUREAU VERITAS	 LRS	 PRS	 RINA
--	---	--	---	---	--

Shipping Approval	other	Railway
-------------------	-------	---------

 RMRS	Confirmation	 VDE
		Vibration and Shock

Further information

- Information- and Downloadcenter (Catalogs, Brochures,...)**
<https://www.siemens.com/ic10>
- Industry Mall (Online ordering system)**
<https://mall.industry.siemens.com/mall/en/en/Catalog/product?mlfb=3RV2925-5AB>
- Cax online generator**
<http://support.automation.siemens.com/WW/CAXorder/default.aspx?lang=en&mlfb=3RV2925-5AB>
- Service&Support (Manuals, Certificates, Characteristics, FAQs,...)**
<https://support.industry.siemens.com/cs/ww/en/ps/3RV2925-5AB>
- Image database (product images, 2D dimension drawings, 3D models, device circuit diagrams, EPLAN macros, ...)**
http://www.automation.siemens.com/bilddb/cax_de.aspx?mlfb=3RV2925-5AB&lang=en

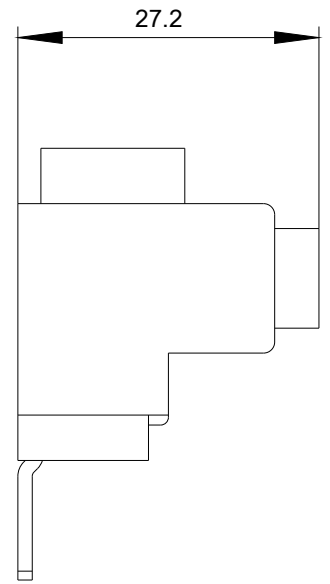
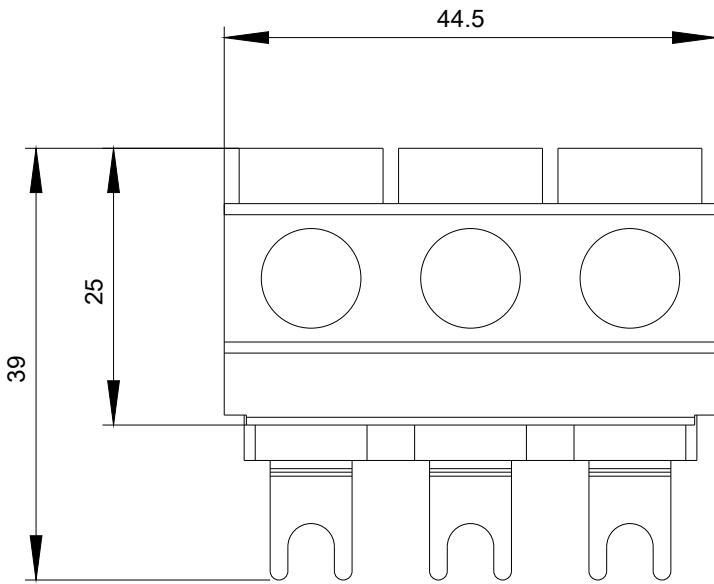

last modified:

12/08/2020