



Circuit breaker size S00 for motor protection, CLASS 10 A-release 1.4...2 A N-release 26 A screw terminal Standard switching capacity





product brand name	SIRIUS
product designation	Circuit breaker
design of the product	For motor protection
product type designation	3RV2
General technical data	
size of the circuit-breaker	S00
size of contactor can be combined company-specific	S00, S0
product extension auxiliary switch	Yes
power loss [W] for rated value of the current	
• at AC in hot operating state	7.25 W
• at AC in hot operating state per pole	2.4 W
insulation voltage with degree of pollution 3 at AC rated value	690 V
surge voltage resistance rated value	6 kV
shock resistance according to IEC 60068-2-27	25g / 11 ms
mechanical service life (operating cycles)	
• of the main contacts typical	100 000
• of auxiliary contacts typical	100 000
electrical endurance (operating cycles) typical	100 000
type of protection according to ATEX directive 2014/34/EU	Ex II (2) GD
certificate of suitability according to ATEX directive 2014/34/EU	DMT 02 ATEX F 001
reference code according to IEC 81346-2	Q
Substance Prohibitance (Date)	10/01/2009
SVHC substance name	Blei - 7439-92-1
Ambient conditions	
installation altitude at height above sea level maximum	2 000 m
ambient temperature	
• during operation	-20 ... +60 °C
• during storage	-50 ... +80 °C
• during transport	-50 ... +80 °C
relative humidity during operation	10 ... 95 %
Main circuit	
number of poles for main current circuit	3
adjustable current response value current of the current-dependent overload release	1.4 ... 2 A
operating voltage	
• rated value	20 ... 690 V
• at AC-3 rated value maximum	690 V
• at AC-3e rated value maximum	690 V
operating frequency rated value	50 ... 60 Hz
operational current rated value	2 A





operational current	
<ul style="list-style-type: none"> • at AC-3 at 400 V rated value • at AC-3e at 400 V rated value 	2 A 2 A
operating power	
<ul style="list-style-type: none"> • at AC-3 <ul style="list-style-type: none"> — at 230 V rated value — at 400 V rated value — at 500 V rated value — at 690 V rated value • at AC-3e <ul style="list-style-type: none"> — at 230 V rated value — at 400 V rated value — at 500 V rated value — at 690 V rated value 	0.4 kW 0.75 kW 0.8 kW 1.1 kW 0.4 kW 0.75 kW 0.8 kW 1.1 kW
operating frequency	
<ul style="list-style-type: none"> • at AC-3 maximum • at AC-3e maximum 	15 1/h 15 1/h
Auxiliary circuit	
number of NC contacts for auxiliary contacts	
•	0
number of NO contacts for auxiliary contacts	
•	0
number of CO contacts for auxiliary contacts	0
Protective and monitoring functions	
product function	
<ul style="list-style-type: none"> • ground fault detection • phase failure detection 	No Yes
trip class	CLASS 10
design of the overload release	thermal
maximum short-circuit current breaking capacity (Icu)	
<ul style="list-style-type: none"> • at AC at 240 V rated value • at AC at 400 V rated value • at AC at 500 V rated value • at AC at 690 V rated value 	100 kA 100 kA 100 kA 10 kA
operating short-circuit current breaking capacity (Ics) at AC	
<ul style="list-style-type: none"> • at 240 V rated value • at 400 V rated value • at 500 V rated value • at 690 V rated value 	100 kA 100 kA 100 kA 10 kA
response value current of instantaneous short-circuit trip unit	26 A
UL/CSA ratings	
full-load current (FLA) for 3-phase AC motor	
<ul style="list-style-type: none"> • at 480 V rated value • at 600 V rated value 	2 A 2 A
yielded mechanical performance [hp]	
<ul style="list-style-type: none"> • for single-phase AC motor <ul style="list-style-type: none"> — at 230 V rated value • for 3-phase AC motor <ul style="list-style-type: none"> — at 460/480 V rated value — at 575/600 V rated value 	0.13 hp 1 hp 1 hp
Short-circuit protection	
product function short circuit protection	Yes
design of the short-circuit trip	magnetic
design of the fuse link for IT network for short-circuit protection of the main circuit	
<ul style="list-style-type: none"> • at 400 V • at 500 V • at 690 V 	gL/gG 25 A gL/gG 25 A gL/gG 20 A
Installation/ mounting/ dimensions	
mounting position	any
fastening method	screw and snap-on mounting onto 35 mm DIN rail according to DIN EN 60715

height	97 mm
width	45 mm
depth	97 mm
required spacing	
<ul style="list-style-type: none"> ● with side-by-side mounting at the side 	0 mm
<ul style="list-style-type: none"> ● for grounded parts at 400 V <ul style="list-style-type: none"> — downwards — upwards — at the side 	30 mm 30 mm 9 mm
<ul style="list-style-type: none"> ● for live parts at 400 V <ul style="list-style-type: none"> — downwards — upwards — at the side 	30 mm 30 mm 9 mm
<ul style="list-style-type: none"> ● for grounded parts at 500 V <ul style="list-style-type: none"> — downwards — upwards — at the side 	30 mm 30 mm 9 mm
<ul style="list-style-type: none"> ● for live parts at 500 V <ul style="list-style-type: none"> — downwards — upwards — at the side 	30 mm 30 mm 9 mm
<ul style="list-style-type: none"> ● for grounded parts at 690 V <ul style="list-style-type: none"> — downwards — upwards — backwards — at the side — forwards 	50 mm 50 mm 0 mm 30 mm 0 mm
<ul style="list-style-type: none"> ● for live parts at 690 V <ul style="list-style-type: none"> — downwards — upwards — backwards — at the side — forwards 	50 mm 50 mm 0 mm 30 mm 0 mm
Connections/ Terminals	
type of electrical connection	
<ul style="list-style-type: none"> ● for main current circuit 	screw-type terminals
arrangement of electrical connectors for main current circuit	Top and bottom
type of connectable conductor cross-sections	
<ul style="list-style-type: none"> ● for main contacts <ul style="list-style-type: none"> — solid or stranded — finely stranded with core end processing ● for AWG cables for main contacts 	2x (0,75 ... 2,5 mm ²), 2x 4 mm ² 2x (0.5 ... 1.5 mm ²), 2x (0.75 ... 2.5 mm ²) 2x (18 ... 14), 2x 12
tightening torque	
<ul style="list-style-type: none"> ● for main contacts with screw-type terminals 	0.8 ... 1.2 N·m
design of screwdriver shaft	Diameter 5 to 6 mm
size of the screwdriver tip	Pozidriv size 2
design of the thread of the connection screw	
<ul style="list-style-type: none"> ● for main contacts 	M3
Safety related data	
proportion of dangerous failures	
<ul style="list-style-type: none"> ● with low demand rate according to SN 31920 ● with high demand rate according to SN 31920 	50 % 50 %
failure rate [FIT] with low demand rate according to SN 31920	50 FIT
B10 value with high demand rate according to SN 31920	5 000
IEC 61508	
T1 value for proof test interval or service life according to IEC 61508	10 a
Electrical Safety	
protection class IP on the front according to IEC 60529	IP20

touch protection on the front according to IEC 60529	finger-safe, for vertical contact from the front
display version for switching status	Handle

Approvals Certificates

General Product Approval					
			Confirmation		KC

General Product Approval	For use in hazardous locations	Test Certificates	Marine / Shipping
			Type Test Certificates/Test Report Special Test Certificate 

Marine / Shipping	other
    	Miscellaneous

other	Railway	Environment
Confirmation		Confirmation EPD Typ II/III (with life cycle assessment)

Further information

- Information on the packaging
<https://support.industry.siemens.com/cs/ww/en/view/109813875>
- Information- and Downloadcenter (Catalogs, Brochures,...)
<https://www.siemens.com/ic10>
- Industry Mall (Online ordering system)
<https://mall.industry.siemens.com/mall/en/en/Catalog/product?mlfb=3RV2011-1BA10>
- Cax online generator
<http://support.automation.siemens.com/WW/CAXorder/default.aspx?lang=en&mlfb=3RV2011-1BA10>
- Service&Support (Manuals, Certificates, Characteristics, FAQs,...)
<https://support.industry.siemens.com/cs/ww/en/ps/3RV2011-1BA10>
- Image database (product images, 2D dimension drawings, 3D models, device circuit diagrams, EPLAN macros, ...)
http://www.automation.siemens.com/bilddb/cax_de.aspx?mlfb=3RV2011-1BA10&lang=en
- Characteristic: Tripping characteristics, I²t, Let-through current
<https://support.industry.siemens.com/cs/ww/en/ps/3RV2011-1BA10/char>
- Further characteristics (e.g. electrical endurance, switching frequency)
<http://www.automation.siemens.com/bilddb/index.aspx?view=Search&mlfb=3RV2011-1BA10&objecttype=14&gridview=view1>

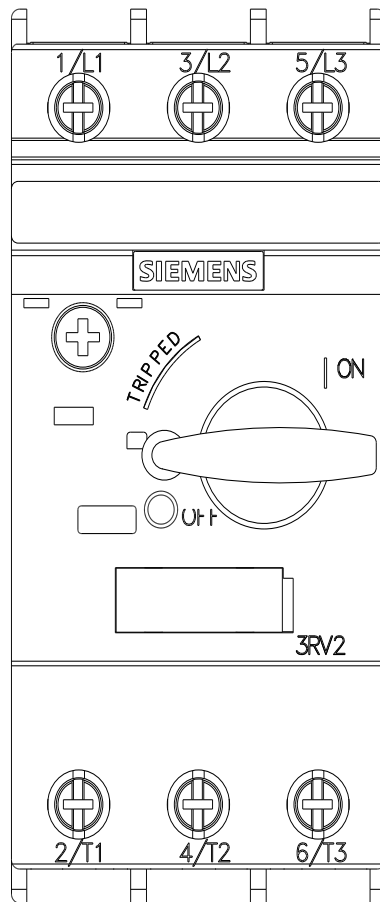



last modified:

8/29/2023 