



Circuit breaker size S00 for motor protection, CLASS 10 A-release 0.18...0.25 A N-release 3.3 A screw terminal Standard switching capacity

product brand name	SIRIUS
product designation	Circuit breaker
design of the product	For motor protection
product type designation	3RV2
General technical data	
size of the circuit-breaker	S00
size of contactor can be combined company-specific	S00, S0
product extension auxiliary switch	Yes
power loss [W] for rated value of the current	
• at AC in hot operating state	5.5 W
• at AC in hot operating state per pole	1.8 W
insulation voltage with degree of pollution 3 at AC rated value	690 V
surge voltage resistance rated value	6 kV
shock resistance according to IEC 60068-2-27	25g / 11 ms
mechanical service life (operating cycles)	
• of the main contacts typical	100 000
• of auxiliary contacts typical	100 000
electrical endurance (operating cycles) typical	100 000
type of protection according to ATEX directive 2014/34/EU	Ex II (2) GD
certificate of suitability according to ATEX directive 2014/34/EU	DMT 02 ATEX F 001
reference code according to IEC 81346-2	Q
Substance Prohibitance (Date)	10/01/2009
SVHC substance name	Blei - 7439-92-1
Ambient conditions	
installation altitude at height above sea level maximum	2 000 m
ambient temperature	
• during operation	-20 ... +60 °C
• during storage	-50 ... +80 °C
• during transport	-50 ... +80 °C
relative humidity during operation	10 ... 95 %
Main circuit	
number of poles for main current circuit	3
adjustable current response value current of the current-dependent overload release	0.18 ... 0.25 A
operating voltage	
• rated value	20 ... 690 V
• at AC-3 rated value maximum	690 V
• at AC-3e rated value maximum	690 V
operating frequency rated value	50 ... 60 Hz
operational current rated value	0.25 A

operational current	
<ul style="list-style-type: none"> at AC-3 at 400 V rated value at AC-3e at 400 V rated value 	0.25 A 0.25 A
operating power	
<ul style="list-style-type: none"> at AC-3 <ul style="list-style-type: none"> at 230 V rated value at 400 V rated value at 500 V rated value at 690 V rated value at AC-3e <ul style="list-style-type: none"> at 230 V rated value at 400 V rated value at 500 V rated value at 690 V rated value 	0 kW 0.06 kW 0.1 kW 0.1 kW 0 kW 0.06 kW 0.1 kW 0.1 kW
operating frequency	
<ul style="list-style-type: none"> at AC-3 maximum at AC-3e maximum 	15 1/h 15 1/h
Auxiliary circuit	
number of NC contacts for auxiliary contacts	
<ul style="list-style-type: none"> 	0
number of NO contacts for auxiliary contacts	
<ul style="list-style-type: none"> 	0
number of CO contacts for auxiliary contacts	
<ul style="list-style-type: none"> 	0
Protective and monitoring functions	
product function	
<ul style="list-style-type: none"> ground fault detection phase failure detection 	No Yes
trip class	CLASS 10
design of the overload release	thermal
maximum short-circuit current breaking capacity (Icu)	
<ul style="list-style-type: none"> at AC at 240 V rated value at AC at 400 V rated value at AC at 500 V rated value at AC at 690 V rated value 	100 kA 100 kA 100 kA 100 kA
operating short-circuit current breaking capacity (Ics) at AC	
<ul style="list-style-type: none"> at 240 V rated value at 400 V rated value at 500 V rated value at 690 V rated value 	100 kA 100 kA 100 kA 100 kA
response value current of instantaneous short-circuit trip unit	3.3 A
UL/CSA ratings	
full-load current (FLA) for 3-phase AC motor	
<ul style="list-style-type: none"> at 480 V rated value at 600 V rated value 	0.25 A 0.25 A
Short-circuit protection	
product function short circuit protection	Yes
design of the short-circuit trip	magnetic
Installation/ mounting/ dimensions	
mounting position	any
fastening method	screw and snap-on mounting onto 35 mm DIN rail according to DIN EN 60715
height	97 mm
width	45 mm
depth	97 mm
required spacing	
<ul style="list-style-type: none"> with side-by-side mounting at the side for grounded parts at 400 V <ul style="list-style-type: none"> downwards upwards at the side for live parts at 400 V 	0 mm 30 mm 30 mm 9 mm

— downwards	30 mm
— upwards	30 mm
— at the side	9 mm
• for grounded parts at 500 V	
— downwards	30 mm
— upwards	30 mm
— at the side	9 mm
• for live parts at 500 V	
— downwards	30 mm
— upwards	30 mm
— at the side	9 mm
• for grounded parts at 690 V	
— downwards	50 mm
— upwards	50 mm
— backwards	0 mm
— at the side	30 mm
— forwards	0 mm
• for live parts at 690 V	
— downwards	50 mm
— upwards	50 mm
— backwards	0 mm
— at the side	30 mm
— forwards	0 mm

Connections/ Terminals

type of electrical connection	
• for main current circuit	screw-type terminals
arrangement of electrical connectors for main current circuit	Top and bottom
type of connectable conductor cross-sections	
• for main contacts	
— solid or stranded	2x (0,75 ... 2,5 mm ²), 2x 4 mm ²
— finely stranded with core end processing	2x (0.5 ... 1.5 mm ²), 2x (0.75 ... 2.5 mm ²)
• for AWG cables for main contacts	2x (18 ... 14), 2x 12
tightening torque	
• for main contacts with screw-type terminals	0.8 ... 1.2 N·m
design of screwdriver shaft	Diameter 5 to 6 mm
size of the screwdriver tip	Pozidriv size 2
design of the thread of the connection screw	
• for main contacts	M3

Safety related data

proportion of dangerous failures	
• with low demand rate according to SN 31920	50 %
• with high demand rate according to SN 31920	50 %
failure rate [FIT] with low demand rate according to SN 31920	50 FIT
B10 value with high demand rate according to SN 31920	5 000

IEC 61508

T1 value for proof test interval or service life according to IEC 61508

10 a

Electrical Safety

protection class IP on the front according to IEC 60529

IP20

touch protection on the front according to IEC 60529

finger-safe, for vertical contact from the front

display version for switching status

Handle

Approvals Certificates











General Product Approval



[Confirmation](#)



[KC](#)

General Product Approval	For use in hazardous locations	Test Certificates		Marine / Shipping
	 ATEX	 IECEX	Special Test Certificate	Type Test Certificates/Test Report  ABS
Marine / Shipping				other
 BUREAU VERITAS	 DNV	 LRS	 PRS	 RINA Miscellaneous
other	Railway	Environment		
Confirmation	 VDE	Confirmation	EPD Typ II/III (with life cycle assessment)	

Further information

Information on the packaging

<https://support.industry.siemens.com/cs/ww/en/view/109813875>

Information- and Downloadcenter (Catalogs, Brochures,...)

<https://www.siemens.com/ic10>

Industry Mall (Online ordering system)

<https://mall.industry.siemens.com/mall/en/en/Catalog/product?mlfb=3RV2011-0CA10>

Cax online generator

<http://support.automation.siemens.com/WWW/CAXorder/default.aspx?lang=en&mlfb=3RV2011-0CA10>

Service&Support (Manuals, Certificates, Characteristics, FAQs,...)

<https://support.industry.siemens.com/cs/ww/en/ps/3RV2011-0CA10>

Image database (product images, 2D dimension drawings, 3D models, device circuit diagrams, EPLAN macros, ...)

http://www.automation.siemens.com/bilddb/cax_de.aspx?mlfb=3RV2011-0CA10&lang=en

Characteristic: Tripping characteristics, I_t, Let-through current

<https://support.industry.siemens.com/cs/ww/en/ps/3RV2011-0CA10/char>

Further characteristics (e.g. electrical endurance, switching frequency)

<http://www.automation.siemens.com/bilddb/index.aspx?view=Search&mlfb=3RV2011-0CA10&objecttype=14&gridview=view1>

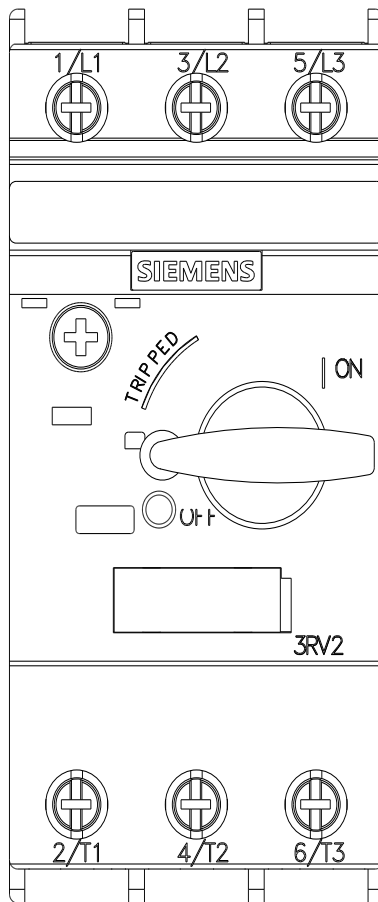



last modified:

8/29/2023 