

PLEASE CHECK WWW.MOLEX.COM FOR LATEST PART INFORMATION

Part Number: [0395326002](#)
Status: **Active**
Overview: Eurostyle Terminal Blocks
Description: 5.08mm Pitch Eurostyle Horizontal PCB Header, Green Housing, 2 Circuits

Documents:

3D Model	Product Specification PS-39500-001-001 (PDF)
Drawing (PDF)	RoHS Certificate of Compliance (PDF)
3D Model (PDF)	

Agency Certification

UL E48521

General

Product Family	Terminal Blocks
Series	39532
Application	N/A
Component Type	PCB Header
Overview	Eurostyle Terminal Blocks
Product Name	ESE, Eurostyle Pluggable
Type	Euro Block
UPC	822350516273

Physical

Circuits (Loaded)	2
Entry Angle	N/A
Lock to Mating Part	Yes
Number of Rows	1
Orientation	Horizontal
PC Tail Length	5.08mm
PCB Thickness - Recommended	3.20mm
Panel Mount	No
Pitch - Mating Interface	5.08mm
Pitch - Termination Interface	5.08mm
Polarized to Mating Part	Yes
Shrouded	Closed Ends
Stackable	No
Surface Mount Compatible (SMC)	N/A
Temperature Range - Operating	-40° to +105°C
Wire Size AWG	N/A

Electrical

Current - Maximum per Contact	15.0A
Voltage - Maximum	300V

Solder Process Data

Lead-free Process Capability	N/A
------------------------------	-----

Material Info

Reference - Drawing Numbers

Product Specification	PS-39500-001-001
Sales Drawing	SD-39532-002-001

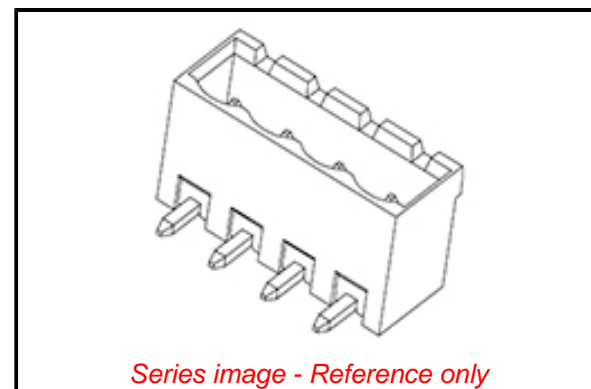

EU ELV

Not Relevant

EU RoHS

Not Reviewed

REACH SVHC

Not Reviewed

Halogen-Free

Status

Not Reviewed

For more information, please visit [Contact US](#)

China ROHS

Not Reviewed

ELV

Not Relevant

RoHS Phthalates

Not Reviewed

China RoHS

Search Parts in this Series

[39532](#) Series

Mates With

[39530](#) Horizontal Plug, [39533](#) Vertical Plug, Most 5.08mm Pitch Industry Standard Plugs