

HiTemp ETX Series Thermoelectric Cooler

The ETX4-7-F2-3030-TA-RT-W6 high temperature, high-performance Thermoelectric Cooler uses Laird's enhanced Thermoelectric Module construction preventing performance degrading copper diffusion, which is common in standard grade Thermoelectric Coolers operating in high temperature environments exceeding 80 °C. It has a maximum Qc of 20.9 Watts when ΔT = 0 and a maximum ΔT of 83.2 °C at Qc = 0.

Features

- High-temperature operation
- Reliable solid-state
- No sound or vibration
- Environmentally-friendly
- RoHS-compliant

Applications

- Peltier Cooling for Refrigerated Centrifuges
- Peltier Cooling for Machine Vision
- Thermoelectric Cooling for CMOS Sensors
- Cooling Solutions for Autonomous Systems
- Peltier Cooling for Digital
- Light Processors

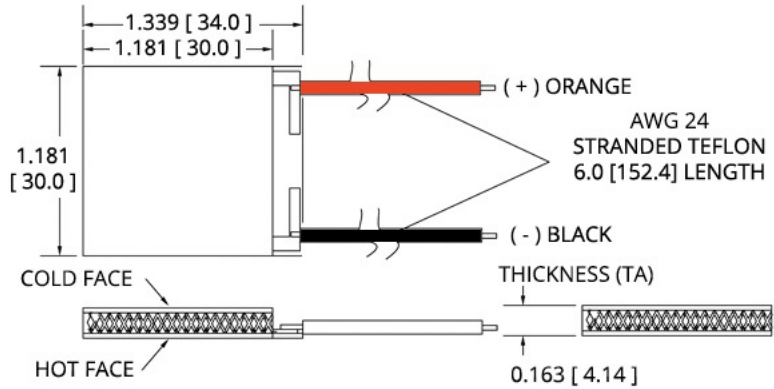
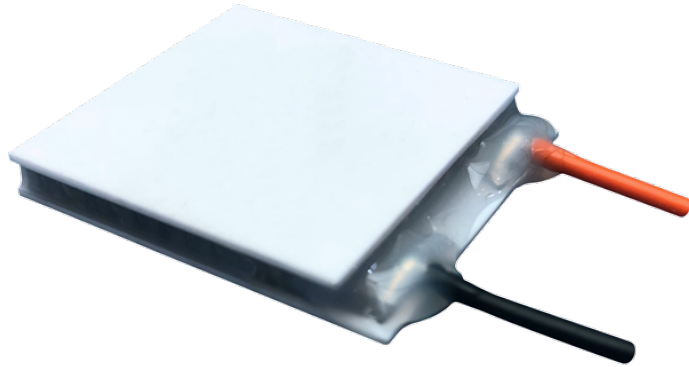

Ceramic Material: Alumina (Al₂O₃)
 Solder Construction: 232°C, SbSn

INCHES [MM]

Note: Allow 0.020 in [0.5 mm] around perimeter of the thermoelectric cooler and lead wire attachment to accommodate sealant

ELECTRICAL AND THERMAL PERFORMANCE

Heat Pumped at Cold Side
 Thot = 85 °C

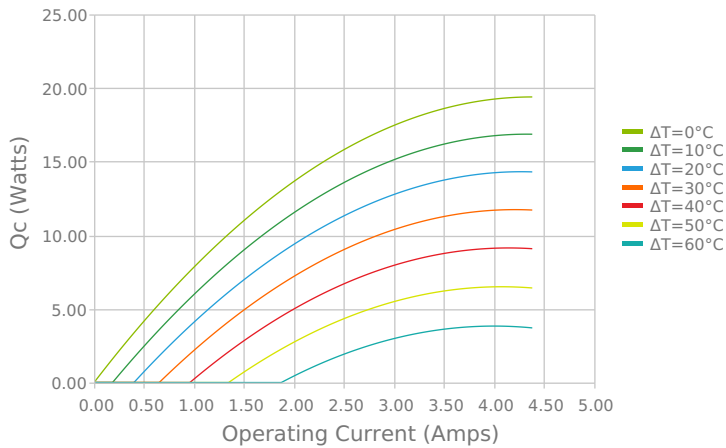

Heat Pumped at Cold Side
 Thot = 85 °C

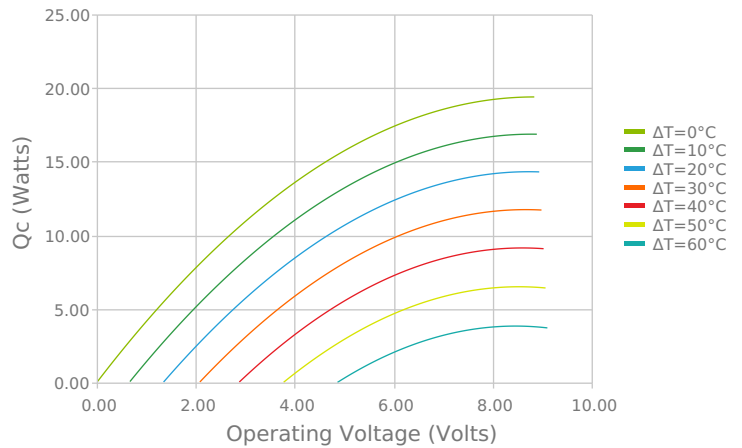

Current vs Voltage (I vs V)
 Thot = 85 °C

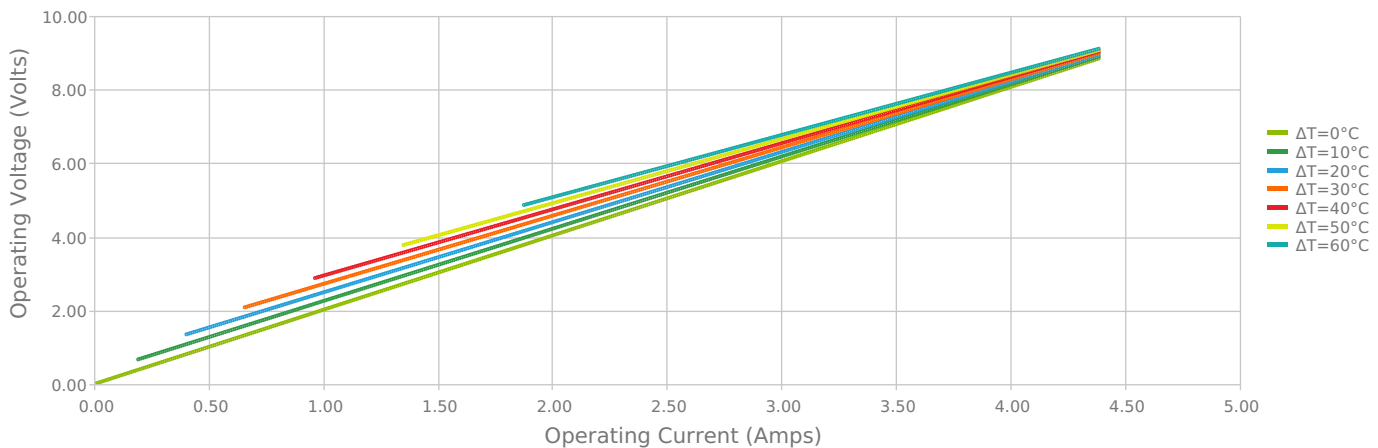

Coefficient of Performance (COP = Qc/Pin)
 Thot = 85 °C

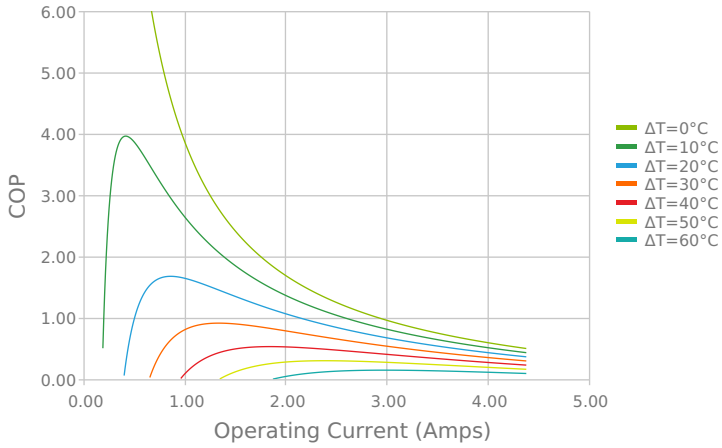

Coefficient of Performance (COP = Qc/Pin)
 Thot = 85 °C

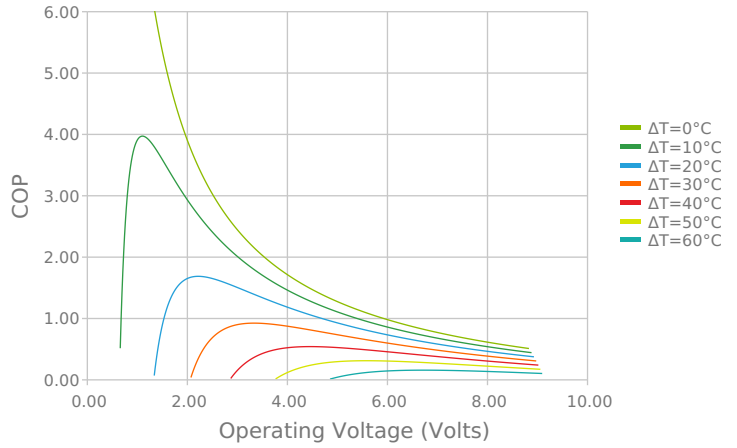

Total Heat Dissipated at Hot Side (Qh=Qc+Pin)
 Thot = 85 °C

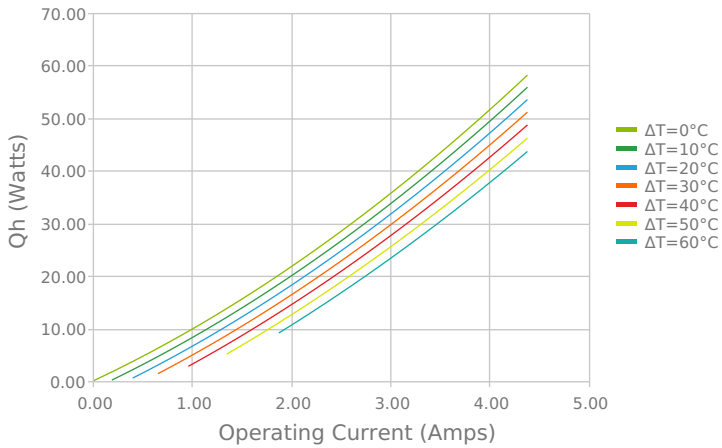

Total Heat Dissipated at Hot Side (Qh=Qc+Pin)
 Thot = 85 °C

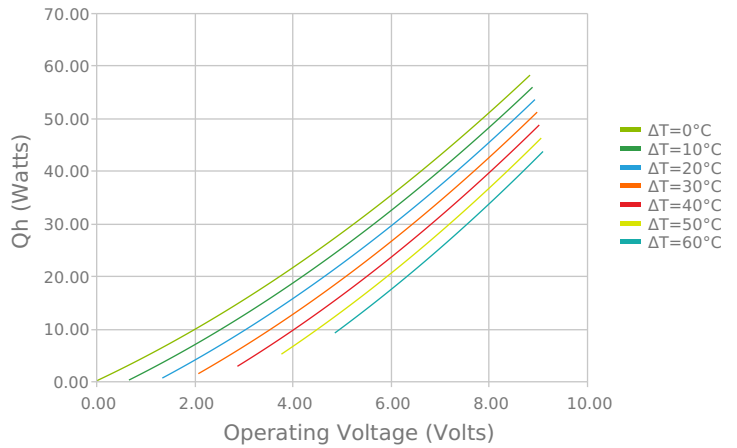

Heat Pumped at Cold Side (Qc)
 Thot = 85 °C | Current = 3.3 Amps

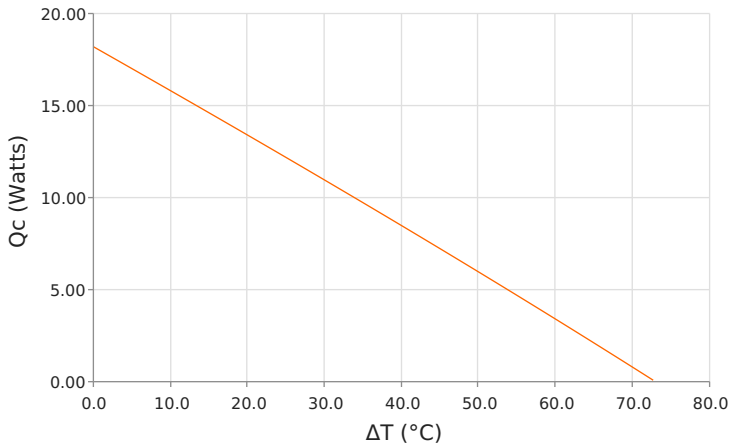

Coefficient of Performance (COP = Qc/Pin)
 Thot = 85 °C | Current = 3.3 Amps

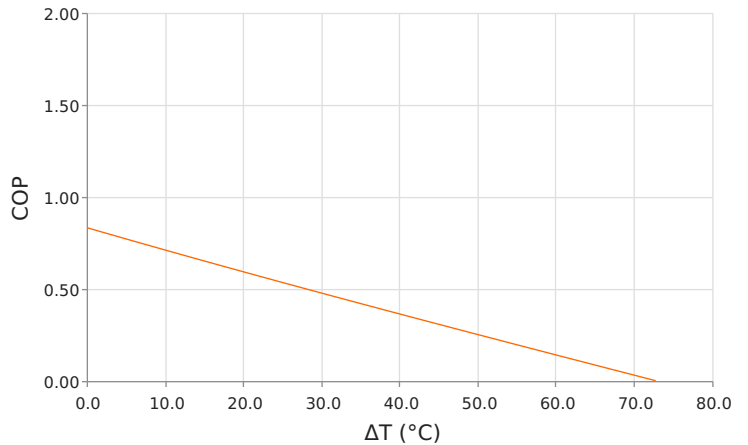

SPECIFICATIONS*

Hot Side Temperature	50.0 °C	85.0 °C	110.0 °C
Qcmax ($\Delta T = 0$)	20.9 Watts	22.6 Watts	23.3 Watts
ΔT_{max} ($Q_c = 0$)	83.2°C	95.3°C	102.0°C
I_{max} (I @ ΔT_{max})	3.8 Amps	3.7 Amps	3.6 Amps
V_{max} (V @ ΔT_{max})	9.3 Volts	10.7 Volts	11.6 Volts
Module Resistance	2.27 Ohms	2.65 Ohms	2.90 Ohms
Max Operating Temperature	150 °C		
Weight	11.0 gram(s)		

* Specifications reflect thermoelectric coefficients updated March 2020

FINISHING OPTIONS

Suffix	Thickness	Flatness / Parallelism	Hot Face	Cold Face	Lead Length
TA	4.140 ± 0.254 mm 0.163 ± 0.010 in	0.025 mm / 0.025 mm 0.001 in / 0.001 in	Lapped	Lapped	152.4 mm 6.00 in

SEALING OPTIONS

Suffix	Sealant	Color	Temp Range	Description
RT	RTV	Translucent or White	-60 to 204°C	Non-corrosive, silicone adhesive

NOTES

1. Max operating temperature: 150°C
2. Do not exceed I_{max} or V_{max} when operating module
3. Reference assembly guidelines for recommended installation

Any information furnished by Laird and its agents, whether in specifications, data sheets, product catalogues or otherwise, is believed to be (but is not warranted as being) accurate and reliable, is provided for information only and does not form part of any contract with Laird. All specifications are subject to change without notice. Laird assumes no responsibility and disclaims all liability for losses or damages resulting from use of or reliance on this information. All Laird products are sold subject to the Laird Terms and Conditions of sale (including Laird's limited warranty) in effect from time to time, a copy of which will be furnished upon request.

© Copyright 2020 Laird Thermal Systems GmbH. All Rights Reserved. Laird, Laird Technologies, Laird Thermal Systems, the Laird Logo, and other word marks and logos are trademarks or registered trademarks of Laird Limited or an affiliate company thereof. Other product or service names may be the property of third parties. Nothing herein provides a license under any Laird or any third party intellectual property rights.

Date: 07/22/2020