

368165-1 ✓ ACTIVE

Econoseal

TE Internal #: 368165-1

Other Automotive Connector Accessories, Mounting Clip, PA,  
Black, -40 – 120 °C [-40 – 248 °F], Econoseal

[View on TE.com >](#)



Connectors > Automotive Connectors > Automotive Connector Accessories > Other Automotive Connector Accessories

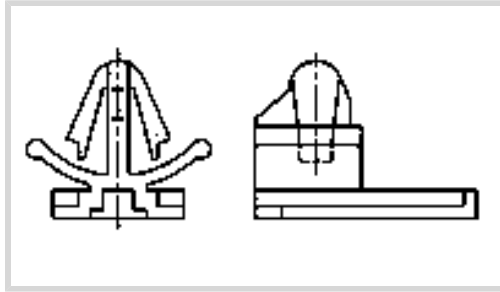

Automotive Connector Accessory Type: **Mounting Clip**

Primary Product Material: **PA**

Primary Product Color: **Black**

Operating Temperature Range: **-40 – 120 °C [-40 – 248 °F]**

## Features

### Product Type Features

Automotive Connector Accessory Type	Mounting Clip
-------------------------------------	---------------

### Body Features

Primary Product Material	PA
Primary Product Color	Black

### Usage Conditions

Operating Temperature Range	-40 – 120 °C[-40 – 248 °F]
-----------------------------	----------------------------

### Industry Standards

UL Flammability Rating	UL 94HB
------------------------	---------

### Packaging Features

Packaging Quantity	1000
Packaging Method	Bag

### Other

Serviceable	Yes
-------------	-----

## Product Compliance

[For compliance documentation, visit the product page on TE.com>](#)

EU RoHS Directive 2011/65/EU	Compliant
EU ELV Directive 2000/53/EC	Compliant
China RoHS 2 Directive MIIT Order No 32, 2016	No Restricted Materials Above Threshold



EU REACH Regulation (EC) No. 1907/2006

Current ECHA Candidate List: JUNE 2022 (224)

Candidate List Declared Against: JUNE 2022 (224)

Does not contain REACH SVHC

Halogen Content

Low Halogen - Br, Cl, F, I < 900 ppm per homogenous material. Also BFR/CFR/PVC Free

Solder Process Capability

Not applicable for solder process capability

Product Compliance Disclaimer

This information is provided based on reasonable inquiry of our suppliers and represents our current actual knowledge based on the information they provided. This information is subject to change. The part numbers that TE has identified as EU RoHS compliant have a maximum concentration of 0.1% by weight in homogenous materials for lead, hexavalent chromium, mercury, PBB, PBDE, DBP, BBP, DEHP, DIBP, and 0.01% for cadmium, or qualify for an exemption to these limits as defined in the Annexes of Directive 2011/65/EU (RoHS2). Finished electrical and electronic equipment products will be CE marked as required by Directive 2011/65/EU. Components may not be CE marked. Additionally, the part numbers that TE has identified as EU ELV compliant have a maximum concentration of 0.1% by weight in homogenous materials for lead, hexavalent chromium, and mercury, and 0.01% for cadmium, or qualify for an exemption to these limits as defined in the Annexes of Directive 2000/53/EC (ELV). Regarding the REACH Regulation, the information TE provides on SVHC in articles for this part number is based on the latest European Chemicals Agency (ECHA) 'Guidance on requirements for substances in articles' posted at this URL: <https://echa.europa.eu/guidance-documents/guidance-on-reach>

## Compatible Parts



TE Part # CAT-M8793-CH8172  
MQS, CONNECTOR HOUSING



TE Part # CAT-M9194-CH8172  
MULTILOCK, CONNECTOR HOUSING

## Also in the Series | Econoseal



Automotive Connector Caps & Covers (1)



Automotive Connector Locks & Position Assurance(25)



Automotive Housings(62)



Automotive Seals & Cavity Plugs(17)



Automotive Terminals(47)



Insertion & Extraction Tools(7)



Other Automotive Connector Accessories(5)



PCB Headers & Receptacles(4)



Primary Wire(1)

### Customers Also Bought

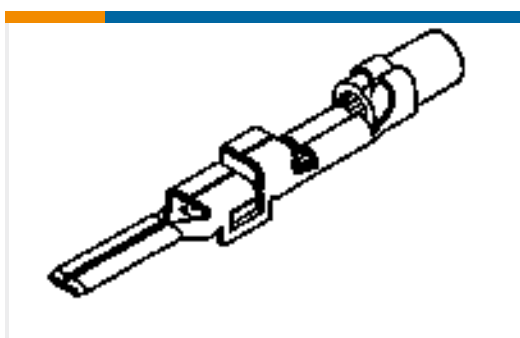

TE Part #368088-1  
090III NON SLD TAB(SQ 0.3-0.5)



TE Part #5-1418758-1  
MCON 1.2 LL TAB STC SN

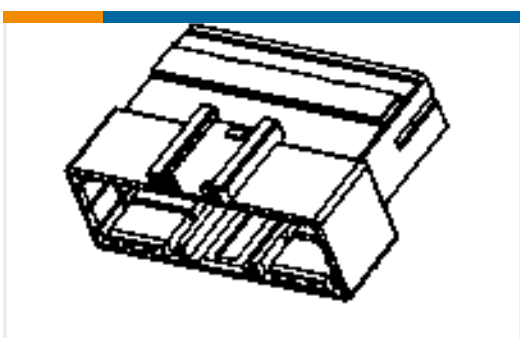

TE Part #936238-1  
090III 4P CAP ASSY

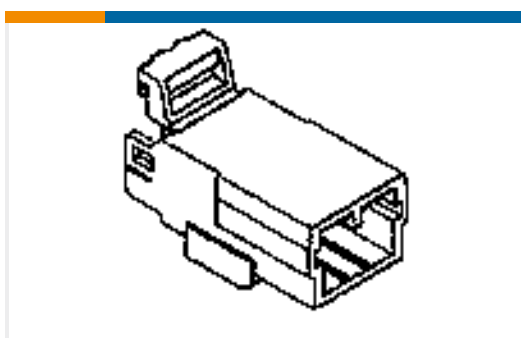

TE Part #174929-1  
070 MLC W-W CAP HSG 4P NATURAL



TE Part #368036-1  
CLIP FOR 070 & EJ MK-II(DAEWOO



TE Part #1-2355506-1  
2POS,MCON 1.2,REC HSG ASSY,SLD, COD A



TE Part #2374441-1  
CAS HTS MIL PN A211B-028A0Z, L-400MM



TE Part #2374441-2  
CAS HTS MIL PN A211D-028A0Z, L-300MM

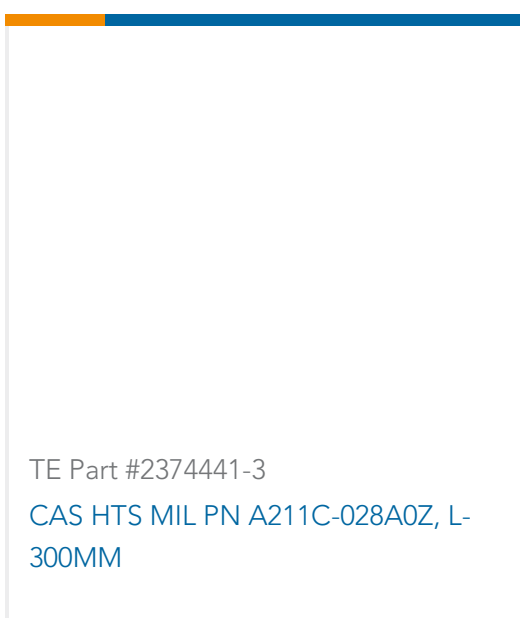

TE Part #2374441-3  
CAS HTS MIL PN A211C-028A0Z, L-300MM

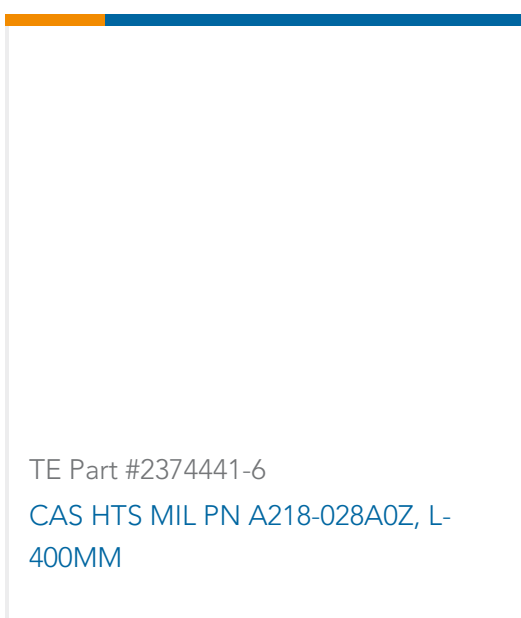

TE Part #2374441-6  
CAS HTS MIL PN A218-028A0Z, L-400MM

### Documents



## Product Drawings

### CLIP HSG FOR 070/EJ MK-II(+)

English

---

## CAD Files

### Customer View Model

[ENG\\_CVM\\_CVM\\_368165-1\\_O.2d\\_dxf.zip](#)

English

### 3D PDF

3D

### Customer View Model

[ENG\\_CVM\\_CVM\\_368165-1\\_O.3d\\_igs.zip](#)

English

### Customer View Model

[ENG\\_CVM\\_CVM\\_368165-1\\_O.3d\\_stp.zip](#)

English

By downloading the CAD file I accept and agree to the [Terms and Conditions](#) of use.