

SCHOTTKY RECTIFIER
HIGH EFFICIENCY SERIES

35SCGQ060

35 Amp, 60V

Major Ratings and Characteristics

Characteristics	35SCGQ060	Units
$I_{F(AV)}$	35	A
V_{RRM} (Per Leg)	60	V
I_{FSM} @ $t_p = 8.3ms$ half-sine (Per Leg)	400	A
V_F @ 17.5Apk, $T_J = 125^\circ C$ (Per Leg)	0.61	V
T_J, T_{stg} Operating and storage	-55 to 150	$^\circ C$

Description/Features

The 35SCGQ060 center tap Schottky rectifier has been expressly designed to meet the rigorous requirements of hirel environments. It is packaged in the hermetic isolated TO-254AA package. The device's forward voltage drop and reverse leakage current are optimized for the lowest power loss and the highest circuit efficiency for typical high frequency switching power supplies and resonant power converters. Full MIL-PRF-19500 quality conformance testing is available on source control drawings to TX, TXV and S quality levels.

- Hermetically Sealed
- Center Tap
- Low Forward Voltage Drop
- High Frequency Operation
- Guard Ring for Enhanced Ruggedness and Long term Reliability
- Lightweight

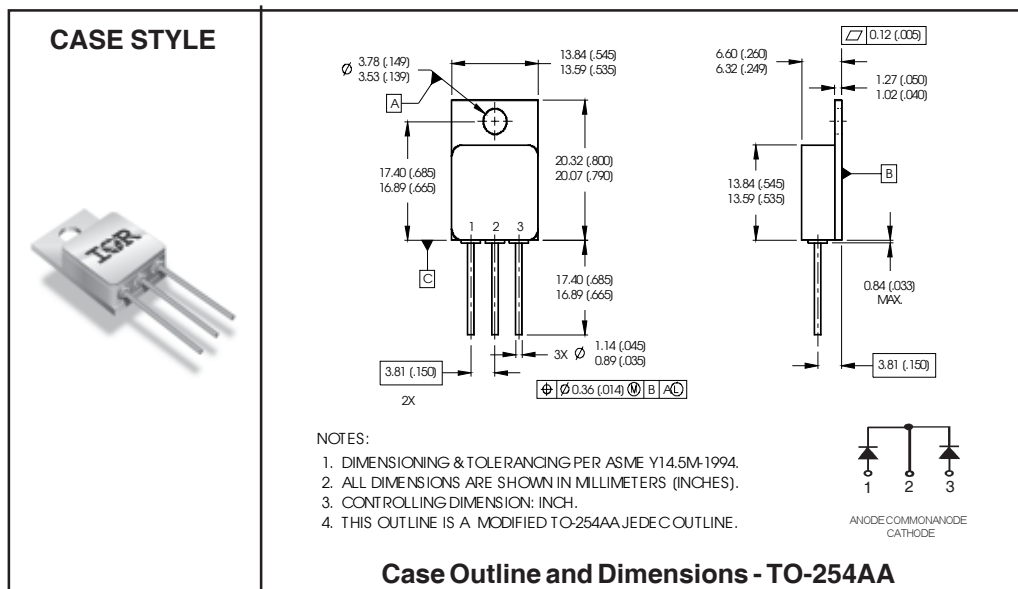

Voltage Ratings

Part number	35SCGQ060
V _R Max. DC Reverse Voltage (V) (Per Leg)	60
V _{RWM} Max. Working Peak Reverse Voltage (V) (Per Leg)	

Absolute Maximum Ratings

Parameters	Limits	Units	Conditions
I _{F(AV)} Max. Average Forward Current See Fig. 5	35	A	50% duty cycle @ T _C = 113 °C, square waveform
I _{FSM} Max. Peak One Cycle Non - Repetitive Surge Current (Per Leg)	400	A	@ t _p = 8.3 ms half-sine

Electrical Specifications

Parameters	Limits	Units	Conditions
V _{FM} Max. Forward Voltage Drop (Per Leg) See Fig. 1 ①	0.64	V	@ 17.5A T _J = -55°C
	0.82	V	@ 35A
	0.61	V	@ 17.5A T _J = 25°C
	0.86	V	@ 35A
	0.61	V	@ 17.5A T _J = 125°C
I _{RM} Max. Reverse Leakage Current (Per Leg) See Fig. 2 ①	0.22	mA	T _J = 25°C
	40	mA	T _J = 100°C
	180	mA	T _J = 125°C
C _T Max. Junction Capacitance (Per Leg)	1520	pF	V _R = 5V _{DC} (1MHz, 25°C)
L _S Typical Series Inductance (Per Leg)	7.8	nH	Measured from anode lead to cathode lead 6mm (0.025 in.) from package

Thermal-Mechanical Specifications

Parameters	Limits	Units	Conditions
T _J Max. Junction Temperature Range	-55 to 150	°C	
T _{stg} Max. Storage Temperature Range	-55 to 150	°C	
R _{thJC} Max. Thermal Resistance, Junction to Case (Per Leg)	1.25	°C/W	DC operation See Fig. 4
R _{thJC} Max. Thermal Resistance, Junction to Case (Per Package)	0.63	°C/W	DC operation
wt Weight (Typical)	9.3	g	
Die Size (Typical)	150X180	mils	
Case Style	TO-254AA		

① Pulse Width < 300µs, Duty Cycle < 2%

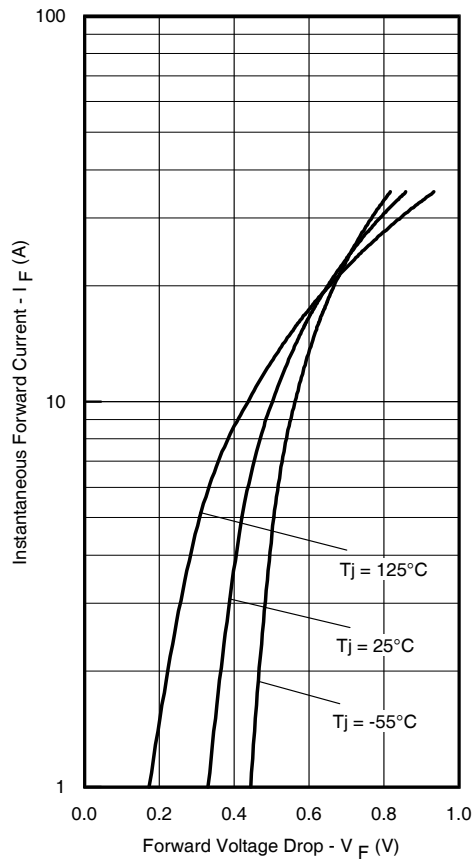

Fig. 1 - Max. Forward Voltage Drop Characteristics (Per Leg)

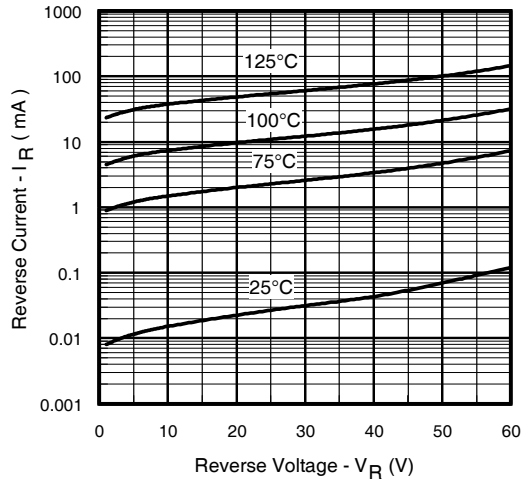

Fig. 2 - Typical Values of Reverse Current Vs. Reverse Voltage (Per Leg)

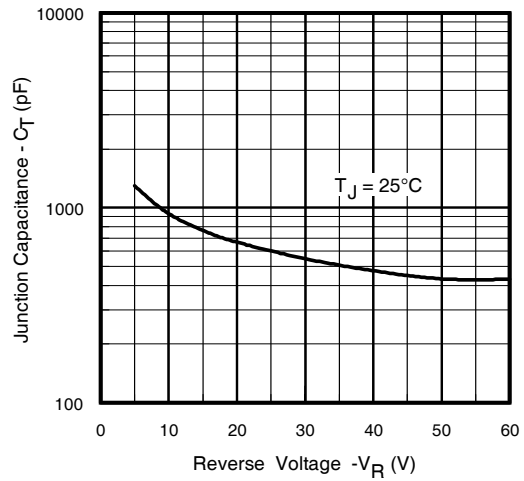

Fig. 3 - Typical Junction Capacitance Vs. Reverse Voltage (Per Leg)

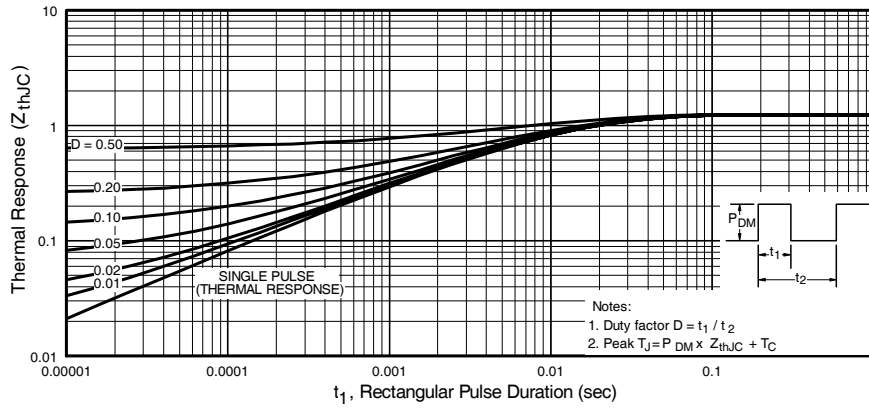

Fig. 4 - Max. Thermal Impedance Z_{thJC} Characteristics (Per Leg)

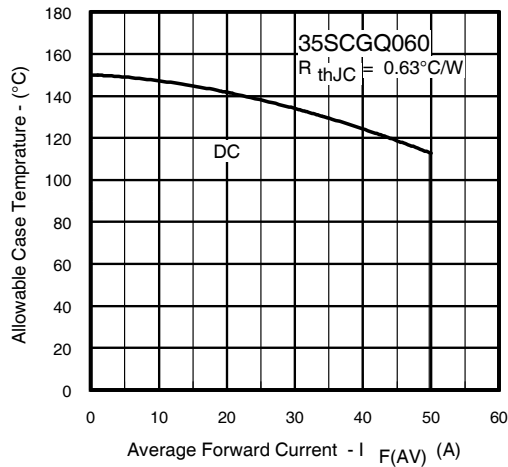

Fig. 5 - Max. Allowable Case Temperature Vs. Average Forward Current