

PLEASE CHECK WWW.MOLEX.COM FOR LATEST PART INFORMATION

Part Number: [35312-0760](#)
Status: **Active**
Description: 2.50mm Pitch Header, Vertical, Shrouded, with Positive Lock, 7 Circuits, PA Polyamide (Nylon) 6/6, Glass-filled, Natural, Lead-Free

Documents:

3D Model	Packaging Specification PK-35312-013 (PDF)
Drawing (PDF)	Packaging Specification PK-35312-014 (PDF)
Product Specification PS-35155-002 (PDF)	RoHS Certificate of Compliance (PDF)

Agency Certification

CSA	LR19980
TUV	E9450420E01
UL	E29179

General

Product Family	PCB Headers
Series	35312
Application	Signal, Wire-to-Board
Product Name	N/A
UPC	822348799251

Physical

Breakaway	No
Circuits (Loaded)	7
Circuits (maximum)	7
Color - Resin	Natural
Durability (mating cycles max)	30
First Mate / Last Break	No
Flammability	94V-0
Glow-Wire Compliant	No
Guide to Mating Part	No
Keying to Mating Part	None
Lock to Mating Part	Yes
Material - Plating Mating	Tin
Material - Plating Termination	Tin
Material - Resin	Nylon
Net Weight	0.687/g
Number of Rows	1
Orientation	Vertical
PC Tail Length	3.40mm
PCB Locator	No
PCB Retention	None
PCB Thickness - Recommended	1.60mm
Packaging Type	Bag
Pitch - Mating Interface	2.50mm
Pitch - Termination Interface	2.50mm
Plating min - Mating	5.080µm
Plating min - Termination	5.080µm
Polarized to PCB	No
Shrouded	Partial
Stackable	No
Surface Mount Compatible (SMC)	No
Temperature Range - Operating	-40°C to +105°C
Termination Interface: Style	Through Hole

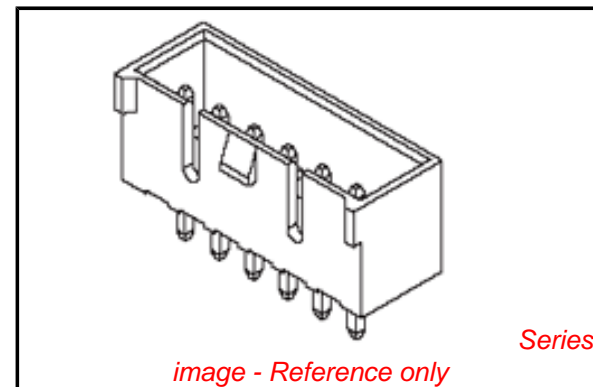

EU RoHS

ELV and RoHS Compliant
REACH SVHC
Contains SVHC: No
Low-Halogen Status
Not Low-Halogen

China RoHS



Need more information on product environmental compliance?

Email productcompliance@molex.com
 For a multiple part number RoHS Certificate of Compliance, [click here](#)

Please visit the [Contact Us](#) section for any non-product compliance questions.

Search Parts in this Series

[35312Series](#)

Mates With

Wire-to-Wire and Wire-to-Board Housing
[35572 Crimp Housing](#), [35155](#)

Electrical

Current - Maximum per Contact

3A

Voltage - Maximum

250V

Material Info**Reference - Drawing Numbers**

Packaging Specification

PK-35312-013, PK-35312-014

Product Specification

PS-35155-002

Sales Drawing

SD-35312-001, SD-35312-004, SD-35312-005

This document was generated on 06/03/2013

PLEASE CHECK WWW.MOLEX.COM FOR LATEST PART INFORMATION