

PLEASE CHECK WWW.MOLEX.COM FOR LATEST PART INFORMATION

Part Number: [35156-0600](#)
Status: **Active**
Description: 3.96mm Pitch Wire-to-Board Housing: Positive Locking, 6 Circuits, Natural

Documents:

3D Model	Product Specification PS-35156-003 (PDF)
Drawing (PDF)	Packaging Specification PK-35156-001 (PDF)
Product Specification PS-35156-001 (PDF)	RoHS Certificate of Compliance (PDF)

Agency Certification

CSA	LR19980
TUV	R72081037
UL	E29179

General

Product Family	Crimp Housings
Series	35156
Application	Power, Wire-to-Board
Product Name	N/A
UPC	800754375870

Physical

Breakaway	No
Circuits (maximum)	6
Color - Resin	Natural
Flammability	94V-0
Gender	Female
Glow-Wire Compliant	No
Keying to Mating Part	None
Lock to Mating Part	Yes
Material - Resin	Polyester
Net Weight	1.573/g
Number of Rows	1
Packaging Type	Bag
Panel Mount	No
Pitch - Mating Interface	3.96mm
Pitch - Termination Interface	3.96mm
Stackable	No
Temperature Range - Operating	-40°C to +105°C

Material Info

Reference - Drawing Numbers

Packaging Specification	PK-35156-001
Product Specification	PS-35156-001, PS-35156-003, RPS-35156-002, RPS-35156-003, RPS-35156-101
Sales Drawing	SD-35156-**0*

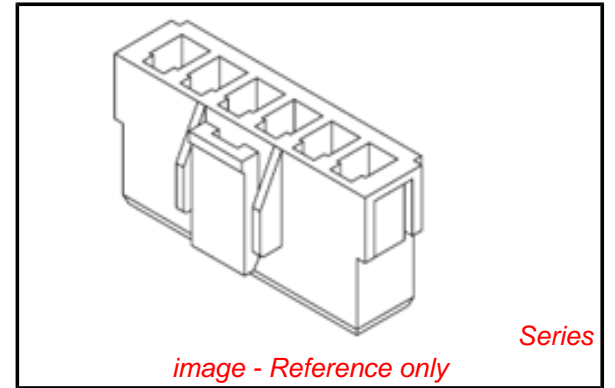

EU RoHS

ELV and RoHS Compliant
REACH SVHC Contains SVHC: No
Low-Halogen Status Not Low-Halogen

China RoHS



Need more information on product environmental compliance?

Email productcompliance@molex.com
 For a multiple part number RoHS Certificate of Compliance, [click here](#)

Please visit the [Contact Us](#) section for any non-product compliance questions.

Search Parts in this Series

[35156Series](#)

Mates With

Use With

[50217 Crimp Terminals](#)