

PLEASE CHECK WWW.MOLEX.COM FOR LATEST PART INFORMATION

Part Number: [35155-0801](#)
Status: **Active**
Description: 2.50mm Pitch Wire-to-Board Housing, Positive Lock, Black, 8 Circuits

Documents:

3D Model	Product Specification PS-68143-001 (PDF)
Drawing (PDF)	Packaging Specification PK-35155-001 (PDF)
Product Specification PS-35155-001 (PDF)	RoHS Certificate of Compliance (PDF)
Product Specification PS-35155-002 (PDF)	

Agency Certification

CSA	LR19980
TUV	R72081037
UL	E29179

General

Product Family	Crimp Housings
Series	35155
Application	Signal, Wire-to-Wire
Product Name	N/A
UPC	756054257425

Physical

Breakaway	No
Circuits (maximum)	8
Color - Resin	Natural
Flammability	94V-0
Gender	Female
Glow-Wire Compliant	No
Keying to Mating Part	None
Lock to Mating Part	Yes
Material - Resin	Polyester
Net Weight	0.853/g
Number of Rows	1
Packaging Type	Bag
Panel Mount	No
Pitch - Mating Interface	2.50mm
Pitch - Termination Interface	2.50mm
Polarized to Mating Part	Yes
Temperature Range - Operating	-40°C to +105°C

Material Info

Reference - Drawing Numbers

Packaging Specification	PK-35155-001
Product Specification	PS-35155-001, PS-35155-002, PS-68143-001
Sales Drawing	SD-35155-**0*

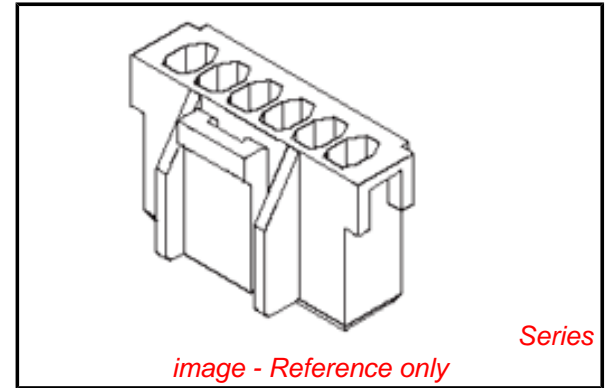

EU RoHS

ELV and RoHS Compliant
REACH SVHC
Contains SVHC: No
Low-Halogen Status
Not Low-Halogen

China RoHS



Need more information on product environmental compliance?

Email productcompliance@molex.com
 For a multiple part number RoHS Certificate of Compliance, [click here](#)

Please visit the [Contact Us](#) section for any non-product compliance questions.

Search Parts in this Series

[35155Series](#)

Mates With

[35312 Vertical Shrouded Header](#), [35184 Wire-to-Wire Plug Housing](#)

Use With

[5103 SPOX™ Crimp Terminal](#)