

# High-current terminal block - PTPOWER 95-3L/N/FE



3260118

<https://www.phoenixcontact.com/de/produkte/3260118>

Please be informed that the data shown in this PDF document is generated from our Online Catalog. Please find the complete data in the user documentation. Our General Terms of Use for Downloads are valid.



High-current terminal block, Blocked, nom. voltage: 1000 V, nominal current: 232 A, connection method: PowerTurn connection, 1 level, cross section: 25 mm<sup>2</sup> - 95 mm<sup>2</sup>, mounting type: NS 35/15, color: gray/blue/black-yellow

## Your advantages

- Quick and easy connection is now also possible for large conductors with the high-current terminal block
- In addition to using the existing test connection, pick-off terminal blocks can be connected, each of which can also accommodate two test cables
- The Push-in connection terminal blocks are characterized by the system features of the CLIPLINE complete system and by easy and tool-free wiring of conductors with ferrules or solid conductors
- The compact design enables wiring in a confined space

## Commercial Data

Item number	3260118
Packing unit	2 pc
Minimum order quantity	1 pc
Sales Key	A1 - Reihenklemmen
Product Key	BE2211
Catalog Page	Page 139 (C-1-2019)
GTIN	4046356778985
Weight per Piece (including packing)	1.040 g
Weight per Piece (excluding packing)	984,65 g
Customs tariff number	85369010
Country of origin	PL

# High-current terminal block - PTPOWER 95-3L/N/FE



3260118

<https://www.phoenixcontact.com/de/produkte/3260118>

## Technical Data

### Product properties

Product type	High current terminal block
Number of positions	5
Number of connections	10
Number of rows	1
Potentials	5

### Insulation characteristics

Overvoltage category	III
Degree of pollution	3

### Electrical properties

Rated surge voltage	8 kV
Maximum power dissipation for nominal condition	7.54 W

### Connection data

Number of connections per level	2
Nominal cross section	95 mm <sup>2</sup>

#### 1 level

Stripping length	40 mm
Connection in acc. with standard	IEC 60947-7-1
Conductor cross section solid	25 mm <sup>2</sup> ... 95 mm <sup>2</sup>
Cross section AWG	4 ... 4/0 (converted acc. to IEC)
Conductor cross section flexible	25 mm <sup>2</sup> ... 95 mm <sup>2</sup>
Conductor cross section, flexible [AWG]	4 ... 4/0 (converted acc. to IEC)
Flexible conductor cross section flexible (ferrule, w/o plastic sleeve)	25 mm <sup>2</sup> ... 95 mm <sup>2</sup>
Flexible conductor cross section (ferrule with plastic sleeve)	25 mm <sup>2</sup> ... 95 mm <sup>2</sup>
Cross-section with insertion bridge, rigid	95 mm <sup>2</sup>
Cross-section with insertion bridge, flexible	70 mm <sup>2</sup>
Nominal current	232 A
Maximum load current	232 A (with 95 mm <sup>2</sup> conductor cross section)
Nominal voltage	1000 V

#### 1 level Connection cross sections directly pluggable

Conductor cross section solid	25 mm <sup>2</sup> ... 95 mm <sup>2</sup>
Flexible conductor cross section flexible (ferrule, w/o plastic sleeve)	25 mm <sup>2</sup> ... 95 mm <sup>2</sup>
Flexible conductor cross section (ferrule with plastic sleeve)	25 mm <sup>2</sup> ... 95 mm <sup>2</sup>

### Dimensions

Width	125 mm
-------	--------

# High-current terminal block - PTPOWER 95-3L/N/FE



3260118

<https://www.phoenixcontact.com/de/produkte/3260118>

Height	99.8 mm
Height NS 35/15	108.7 mm
Length	105.5 mm

## Material specifications

Color	gray/blue/black-yellow
Flammability rating according to UL 94	V0
Insulating material group	I
Insulating material	PA
Static insulating material application in cold	-60 °C
Temperature index of insulation material (DIN EN 60216-1 (VDE 0304-21))	125 °C
Relative insulation material temperature index (Elec., UL 746 B)	130 °C
Fire protection for rail vehicles (DIN EN 45545-2) R22	HL 1 - HL 3
Fire protection for rail vehicles (DIN EN 45545-2) R23	HL 1 - HL 3
Fire protection for rail vehicles (DIN EN 45545-2) R24	HL 1 - HL 3
Fire protection for rail vehicles (DIN EN 45545-2) R26	HL 1 - HL 3
Calorimetric heat release NFPA 130 (ASTM E 1354)	27,5 MJ/kg
Surface flammability NFPA 130 (ASTM E 162)	passed
Specific optical density of smoke NFPA 130 (ASTM E 662)	passed
Smoke gas toxicity NFPA 130 (SMP 800C)	passed

## Mechanical properties

### Mechanical data

Open side panel	No
-----------------	----

## Environmental and real-life conditions

### Ambient conditions

Ambient temperature (operation)	-60 °C ... 105 °C (max. short-term operating temperature RTI Elec.)
Ambient temperature (storage/transport)	-25 °C ... 60 °C (for a short time, not exceeding 24 h, -60 °C to +70 °C)
Ambient temperature (assembly)	-5 °C ... 70 °C
Ambient temperature (actuation)	-5 °C ... 70 °C
Permissible humidity (storage/transport)	30 % ... 70 %

## Standards and regulations

Connection in acc. with standard	IEC 60947-7-1
----------------------------------	---------------

## Mounting

Mounting type	NS 35/15
---------------	----------

# High-current terminal block - PTPOWER 95-3L/N/FE

3260118

<https://www.phoenixcontact.com/de/produkte/3260118>

## Drawings

Schematic diagram

### PTPOWER

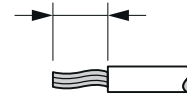

AGK 10-PTPOWER	0,5 mm <sup>2</sup> ... 16 mm <sup>2</sup>	18 mm
PTPOWER 35	2,5 mm <sup>2</sup> ... 35 mm <sup>2</sup>	25 mm
PTPOWER 50	10 mm <sup>2</sup> ... 50 mm <sup>2</sup>	32 mm
PTPOWER 95	25 mm <sup>2</sup> ... 95 mm <sup>2</sup>	40 mm
PTPOWER 185	95 mm <sup>2</sup> ... 185 mm <sup>2</sup>	40 mm

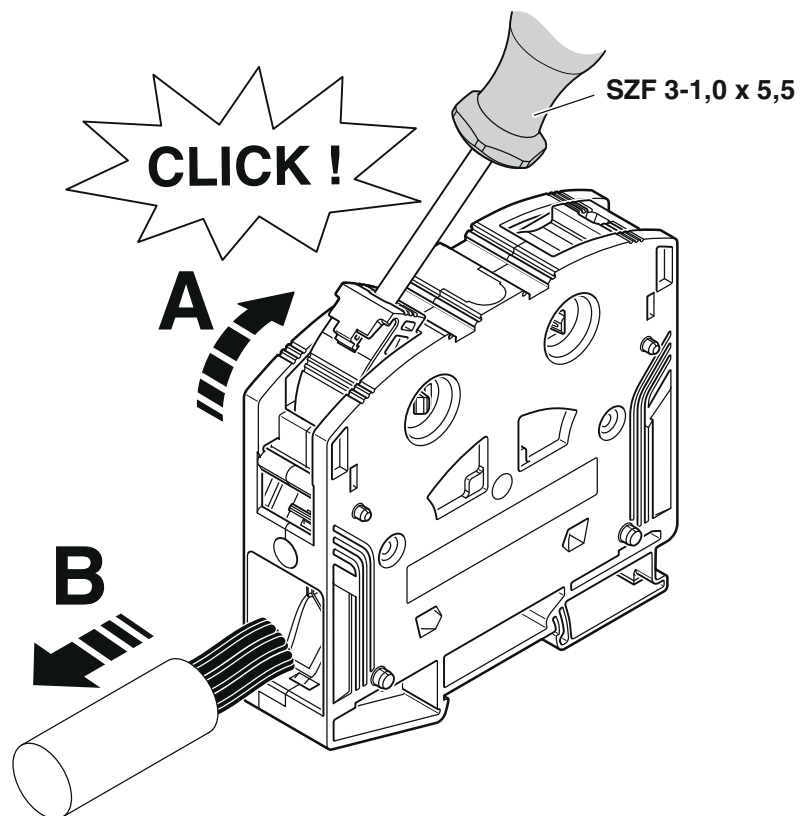

3260118

<https://www.phoenixcontact.com/de/produkte/3260118>

Circuit diagram

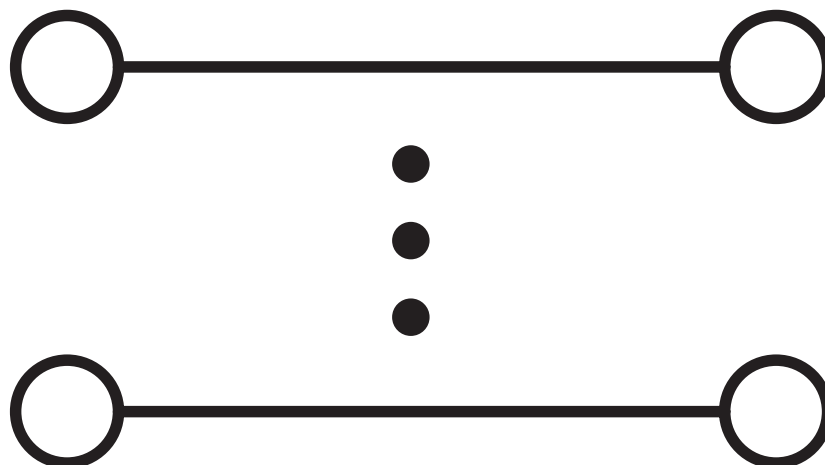

# High-current terminal block - PTPOWER 95-3L/N/FE





3260118

<https://www.phoenixcontact.com/de/produkte/3260118>

## Approvals

 <b>CSA</b> Approval ID: 13631				
	Nominal Voltage $U_N$	Nominal Current $I_N$	Cross Section AWG	Cross Section $\text{mm}^2$
Use group B	600 V	230 A	4 - 4/0	-
Use group C	1000 V	230 A	4 - 4/0	-

 <b>cUL Recognized</b> Approval ID: E60425				
	Nominal Voltage $U_N$	Nominal Current $I_N$	Cross Section AWG	Cross Section $\text{mm}^2$
Use group C	1000 V	230 A	4 - 4/0	-

 <b>UL Recognized</b> Approval ID: E60425				
	Nominal Voltage $U_N$	Nominal Current $I_N$	Cross Section AWG	Cross Section $\text{mm}^2$
Use group E	1000 V	230 A	4 - 4/0	-

 <b>EAC</b> Approval ID: RU C-DE.AI30.B.01102				
---	--	--	--	--

 <b>EAC</b> Approval ID: RU C-DE.BL08.B.00644				
---	--	--	--	--

<b>DNV</b> Approval ID: TAE00000Z9				
---------------------------------------	--	--	--	--

<b>cULus Recognized</b>				
-------------------------	--	--	--	--

# High-current terminal block - PTPOWER 95-3L/N/FE



3260118

<https://www.phoenixcontact.com/de/produkte/3260118>

## Classifications

### ECLASS

ECLASS-9.0	27141120
ECLASS-10.0.1	27141120
ECLASS-11.0	27141120

### ETIM

ETIM 8.0	EC000897
----------	----------

### UNSPSC

UNSPSC 21.0	39121400
-------------	----------

# High-current terminal block - PTPOWER 95-3L/N/FE



3260118

<https://www.phoenixcontact.com/de/produkte/3260118>

## Environmental Product Compliance

China RoHS	Environmentally friendly use period: unlimited = EFUP-e
	No hazardous substances above threshold values

Phoenix Contact 2023 © - all rights reserved  
<https://www.phoenixcontact.com>

PHOENIX CONTACT Deutschland GmbH  
Flachmarktstraße 8  
D-32825 Blomberg  
+49 52 35/3-1 20 00  
[info@phoenixcontact.de](mailto:info@phoenixcontact.de)