

Bolt connection terminal block - RBO 10 BU



3244616

<https://www.phoenixcontact.com/de/produkte/3244616>

Please be informed that the data shown in this PDF document is generated from our Online Catalog. Please find the complete data in the user documentation. Our General Terms of Use for Downloads are valid.



Bolt connection terminal block, nom. voltage: 1000 V, nominal current: 309 A, connection method: Bolt connection, 1 level, Rated cross section: 150 mm², mounting type: NS 35/7,5, NS 35/15, color: blue

Your advantages

- Tested for railway applications

Commercial Data

Item number	3244616
Packing unit	5 pc
Minimum order quantity	5 pc
Sales Key	A1 - Reihenklemmen
Product Key	BE4412
Catalog Page	Page 391 (C-1-2019)
GTIN	4046356724388
Weight per Piece (including packing)	273,6 g
Weight per Piece (excluding packing)	273,6 g
Customs tariff number	85369010
Country of origin	CN

Bolt connection terminal block - RBO 10 BU



3244616

<https://www.phoenixcontact.com/de/produkte/3244616>

Technical Data

Product properties

Product type	Bolt connection terminal block
Number of positions	1
Pitch	41 mm
Area of application	Railway industry
	Machine building
	Plant engineering
Number of connections	2
Number of rows	1
Potentials	1

Insulation characteristics

Overvoltage category	III
Degree of pollution	3

Electrical properties

Rated surge voltage	8 kV
Maximum power dissipation for nominal condition	9.55 W

Connection data

Number of connections per level	2
Nominal cross section	150 mm ²

1 level

Screw thread	M10
Stripping length	The stripping length depends on the specification provided by the cable lug manufacturer.
Connection in acc. with standard	IEC 60947-7-1
Nominal current	309 A
Maximum load current	309 A (with 150 mm ² conductor cross section)
Nominal voltage	1000 V
Nominal cross section	150 mm ²

Cable lug connection DIN 46234:1980-03

Connection in acc. with standard	DIN 46234:1980-03
Cross section	6 mm ² ... 150 mm ²
Cross section range AWG	(converted acc. to IEC)
Hole diameter	10.5 mm
Width	30 mm
Bolt diameter	10 mm
Screw thread	M10
Tightening torque	10 ... 20 Nm
Connection in acc. with standard	DIN 46235:1983-07

Bolt connection terminal block - RBO 10 BU



3244616

<https://www.phoenixcontact.com/de/produkte/3244616>

Cross section	16 mm ² ... 150 mm ²
Cross section range AWG	(converted acc. to IEC)
Hole diameter	10.5 mm
Width	34 mm
Bolt diameter	10 mm
Screw thread	M10
Tightening torque	10 ... 20 Nm
Connection in acc. with standard	DIN 46237:1970-07
Cross section	6 mm ² ... 6 mm ²
Cross section range AWG	(converted acc. to IEC)
Hole diameter	10.5 mm
Width	18 mm
Bolt diameter	10 mm
Screw thread	M10
Tightening torque	10 ... 20 Nm
Identification color of ring cable lugs	
Identification color of ring cable lugs : yellow	6 mm ²

Ex data

Rated data (ATEX/IECEx)

Identification	□ II 2 GD Ex eb IIC Gb
Operating temperature range	-60 °C ... 110 °C
Ex-certified accessories	3247970 HC-RBO 10 0800886 E/NS 35 N
List of bridges	/ RBO 10-VS 2 / 3244643 / RBO 10-VS 3 / 3244656
Bridge data	309 A / 150 mm ²
Ex temperature increase	40 K (309 A / 150 mm ²)
Rated voltage	1100 V
for bridging with bridge	1100 V
Rated insulation voltage	1000 V
output	(Permanent)

Ex level General

Rated current	309 A
Maximum load current	309 A
Contact resistance	0.05 mΩ

Ex connection data General

Torque range	10 Nm ... 20 Nm
Nominal cross section	150 mm ²
Rated cross section AWG	300 kcmil
Connection capacity rigid	6 mm ² ... 150 mm ²
Connection capacity AWG	10 ... 300 kcmil

Bolt connection terminal block - RBO 10 BU



3244616

<https://www.phoenixcontact.com/de/produkte/3244616>

Connection capacity flexible	6 mm ² ... 150 mm ²
Connection capacity AWG	10 ... 300 kcmil
2 conductors with same cross section, solid	6 mm ² ... 150 mm ²
2 conductors with the same cross-section AWG rigid	10 ... 300 kcmil
2 conductors with same cross section, stranded	6 mm ² ... 70 mm ²
2 conductors with the same cross-section AWG flexible	10 ... 300 kcmil

Dimensions

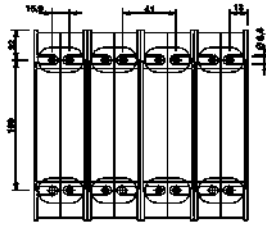
Dimensional drawing	
Width	41 mm
Height NS 35/15	84.5 mm
Height NS 35/7,5	77 mm
Length	144 mm
Bolt length	31 mm
Pitch	41 mm

Material specifications

Color	blue
Flammability rating according to UL 94	V0
Insulating material group	I
Insulating material	PA
Static insulating material application in cold	-60 °C
Temperature index of insulation material (DIN EN 60216-1 (VDE 0304-21))	130 °C
Relative insulation material temperature index (Elec., UL 746 B)	130 °C
Fire protection for rail vehicles (DIN EN 45545-2) R22	HL 1 - HL 3
Fire protection for rail vehicles (DIN EN 45545-2) R23	HL 1 - HL 3
Fire protection for rail vehicles (DIN EN 45545-2) R24	HL 1 - HL 3
Fire protection for rail vehicles (DIN EN 45545-2) R26	HL 1 - HL 3
Calorimetric heat release NFPA 130 (ASTM E 1354)	28 MJ/kg
Surface flammability NFPA 130 (ASTM E 162)	passed
Specific optical density of smoke NFPA 130 (ASTM E 662)	passed
Smoke gas toxicity NFPA 130 (SMP 800C)	passed

Mechanical properties

Mechanical data

Open side panel	No
-----------------	----

Bolt connection terminal block - RBO 10 BU



3244616

<https://www.phoenixcontact.com/de/produkte/3244616>

Environmental and real-life conditions

Ambient conditions

Ambient temperature (operation)	-60 °C ... 105 °C (max. short-term operating temperature RTI Elec.)
Ambient temperature (storage/transport)	-25 °C ... 60 °C (for a short time, not exceeding 24 h, -60 °C to +70 °C)
Ambient temperature (assembly)	-5 °C ... 70 °C
Ambient temperature (actuation)	-5 °C ... 70 °C
Permissible humidity (storage/transport)	30 % ... 70 %

Standards and regulations

Connection in acc. with standard	IEC 60947-7-1
----------------------------------	---------------

Mounting

Mounting type	NS 35/7,5
	NS 35/15

Bolt connection terminal block - RBO 10 BU

3244616

<https://www.phoenixcontact.com/de/produkte/3244616>

Drawings

Dimensional drawing

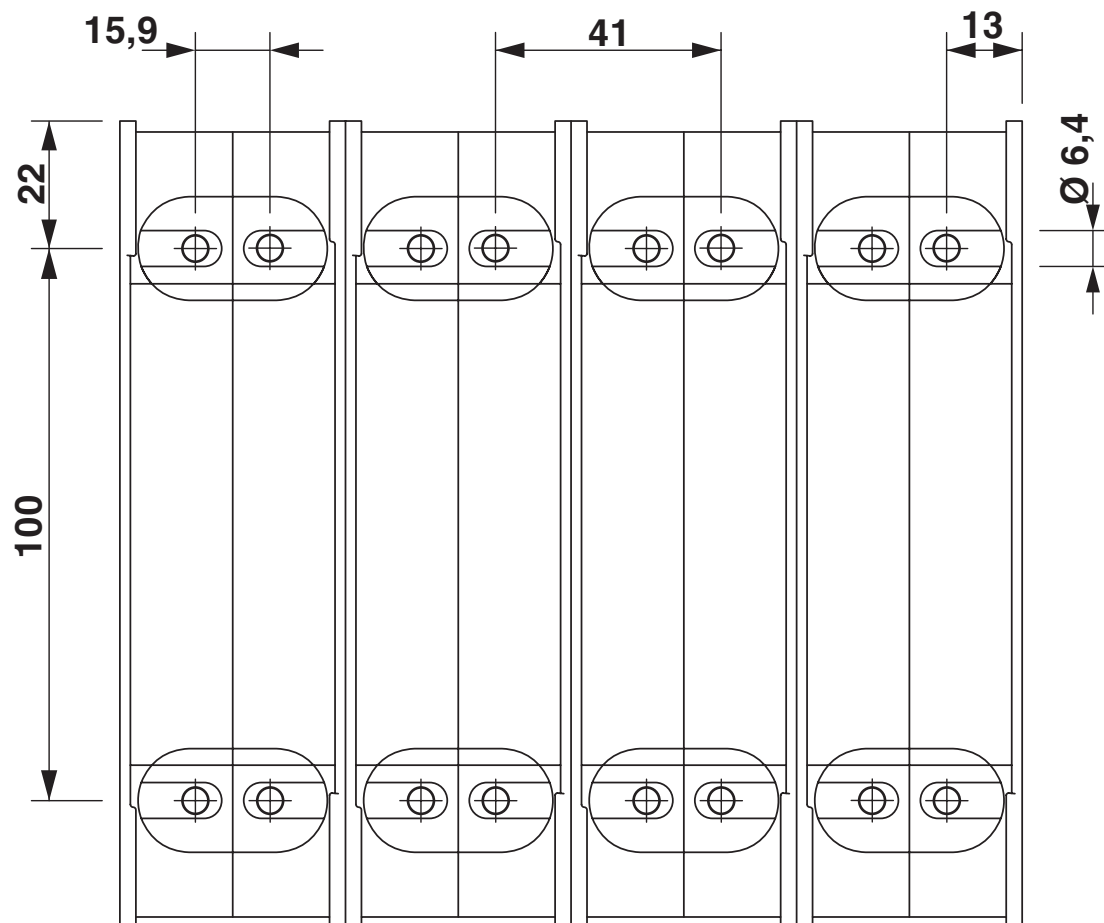

Bolt connection terminal block - RBO 10 BU



3244616

<https://www.phoenixcontact.com/de/produkte/3244616>

Circuit diagram



Bolt connection terminal block - RBO 10 BU



3244616

<https://www.phoenixcontact.com/de/produkte/3244616>

Approvals

 CSA Approval ID: 13631				
	Nominal Voltage U_N	Nominal Current I_N	Cross Section AWG	Cross Section mm^2
Use group B	600 V	310 A	10 - 350	-
Use group C	1000 V	310 A	10 - 350	-
Use group E	600 V	310 A	10 - 350	-

 UL Recognized Approval ID: E60425				
	Nominal Voltage U_N	Nominal Current I_N	Cross Section AWG	Cross Section mm^2
Use group B	600 V	310 A	10 - 350	-
Use group C	600 V	310 A	10 - 350	-
Use group E	1000 V	310 A	10 - 350	-

 EAC Approval ID: RU C-DE.BL08.B.00540				
---	--	--	--	--

DNV Approval ID: TAE00004G1				
---------------------------------------	--	--	--	--

 EAC Ex Approval ID: RU C-DE.HA91.B.00066				
--	--	--	--	--

 IECEX Approval ID: IECEXSEV13.0003U				
	Nominal Voltage U_N	Nominal Current I_N	Cross Section AWG	Cross Section mm^2
	1100 V	309 A	-	6 - 150

 ATEX Approval ID: SEV13ATEX0132U				
	Nominal Voltage U_N	Nominal Current I_N	Cross Section AWG	Cross Section mm^2
	1100 V	309 A	-	6 - 150

Bolt connection terminal block - RBO 10 BU



3244616

<https://www.phoenixcontact.com/de/produkte/3244616>



CCC

Approval ID: 2020322313000627



NEPSI

Approval ID: GYJ20.1202U



UKCA-EX

Approval ID: CML 22UKEX1230U

Bolt connection terminal block - RBO 10 BU



3244616

<https://www.phoenixcontact.com/de/produkte/3244616>

Classifications

ECLASS

ECLASS-9.0	27141120
ECLASS-10.0.1	27141120
ECLASS-11.0	27141120

ETIM

ETIM 8.0	EC000897
----------	----------

UNSPSC

UNSPSC 21.0	39121400
-------------	----------

Bolt connection terminal block - RBO 10 BU



3244616

<https://www.phoenixcontact.com/de/produkte/3244616>

Environmental Product Compliance

China RoHS	Environmentally friendly use period: unlimited = EFUP-e
	No hazardous substances above threshold values

Phoenix Contact 2023 © - all rights reserved
<https://www.phoenixcontact.com>

PHOENIX CONTACT Deutschland GmbH
Flachmarktstraße 8
D-32825 Blomberg
+49 52 35/3-1 20 00
info@phoenixcontact.de