

High-current terminal block - UKH 70 BU



3244601

<https://www.phoenixcontact.com/de/produkte/3244601>

Please be informed that the data shown in this PDF document is generated from our Online Catalog. Please find the complete data in the user documentation. Our General Terms of Use for Downloads are valid.



High-current terminal block, nom. voltage: 1000 V, nominal current: 192 A, connection method: Screw connection, Rated cross section: 70 mm², cross section: 16 mm² - 95 mm², mounting type: NS 35/7,5, NS 35/15, NS 35/15-2,3, NS 32, color: blue

Your advantages

- Reliable cable connection is ensured by three-point centering of the conductor in the prismatic sleeve base
- Tested for railway applications
- Low contact resistance of the contact surface due to ribbing
- Screw locking by means of spring-loaded elements in the clamping part

Commercial Data

Item number	3244601
Packing unit	10 pc
Minimum order quantity	1 pc
Sales Key	A1 - Reihenklemmen
Product Key	BE1311
Catalog Page	Page 191 (C-1-2019)
GTIN	4046356561853
Weight per Piece (including packing)	153,9 g
Weight per Piece (excluding packing)	145,4 g
Customs tariff number	85369010
Country of origin	CN

High-current terminal block - UKH 70 BU



3244601

<https://www.phoenixcontact.com/de/produkte/3244601>

Technical Data

Notes

General

Note	For a reliable contact of multi stranded conductors it is recommended to untwist multi stranded conductors.
------	---

Product properties

Product type	High current terminal block
Number of positions	1
Area of application	Railway industry
	Machine building
	Plant engineering
Number of connections	2
Number of rows	1
Potentials	1

Insulation characteristics

Overvoltage category	III
Degree of pollution	3

Electrical properties

Rated surge voltage	8 kV
Maximum power dissipation for nominal condition	6.27 W

Connection data

Number of connections per level	2
Nominal cross section	70 mm ²

Level 1 above 1 below 1

Screw thread	M8
Tightening torque	8 ... 10 Nm
Stripping length	24 mm
Internal cylindrical gage	A11
Connection in acc. with standard	IEC 60947-7-1
Conductor cross section solid	16 mm ² ... 95 mm ²
Cross section AWG	4 ... 3/0 (converted acc. to IEC)
Conductor cross section flexible	25 mm ² ... 70 mm ²
Conductor cross section, flexible [AWG]	3 ... 2/0 (converted acc. to IEC)
Flexible conductor cross section flexible (ferrule, w/o plastic sleeve)	16 mm ² ... 70 mm ²
Flexible conductor cross section (ferrule with plastic sleeve)	16 mm ² ... 70 mm ²
2 conductors with same cross section, solid	16 mm ² ... 25 mm ²
2 conductors with same cross section, flexible	16 mm ² ... 25 mm ²

High-current terminal block - UKH 70 BU



3244601

<https://www.phoenixcontact.com/de/produkte/3244601>

2 conductors with same cross section, flexible, with ferrule without plastic sleeve	16 mm ² ... 25 mm ²
Nominal current	192 A
Maximum load current	192 A (with 70 mm ² conductor cross section)
Nominal voltage	1000 V
Note	Note: Product releases, connection cross sections and notes on connecting aluminum cables can be found in the download area.
Nominal cross section	70 mm ²

Ex data

Rated data (ATEX/IECEx)

Identification	□ II 2 GD Ex eb IIC Gb
Operating temperature range	-60 °C ... 110 °C
Ex-certified accessories	1201934 VDE-ISS 6 1201659 E/AL-NS 32 1201662 E/AL-NS 35
List of bridges	/ FBI 2-20 N EX / 3213210 / FBI 3-20 N EX / 3213211
Bridge data	180 A / 70 mm ²
Ex temperature increase	40 K (180 A / 70 mm ²)
Rated voltage	880 V (NS 35)
Rated insulation voltage	800 V (NS 35) 630 V (NS 32)
output	(Permanent)

Ex level General

Rated current	180 A
Maximum load current	180 A
Contact resistance	0.08 mΩ

Ex connection data General

Torque range	8 Nm ... 10 Nm
Nominal cross section	70 mm ²
Rated cross section AWG	2/0
Connection capacity rigid	16 mm ² ... 95 mm ²
Connection capacity AWG	4 ... 3/0
Connection capacity flexible	25 mm ² ... 70 mm ²
Connection capacity AWG	3 ... 2/0
2 conductors with same cross section, solid	16 mm ² ... 25 mm ²
2 conductors with the same cross-section AWG rigid	4 ... 3
2 conductors with same cross section, stranded	16 mm ² ... 25 mm ²
2 conductors with the same cross-section AWG flexible	4 ... 3

Dimensions

Width	20.3 mm
-------	---------

High-current terminal block - UKH 70 BU



3244601

<https://www.phoenixcontact.com/de/produkte/3244601>

Height	78.3 mm
Height NS 35/15	87.5 mm
Height NS 35/7,5	80 mm
Height NS 32	85 mm
Length	70.5 mm

Material specifications

Color	blue
Flammability rating according to UL 94	V0
Insulating material group	I
Insulating material	PA
Static insulating material application in cold	-60 °C
Temperature index of insulation material (DIN EN 60216-1 (VDE 0304-21))	130 °C
Relative insulation material temperature index (Elec., UL 746 B)	130 °C
Fire protection for rail vehicles (DIN EN 45545-2) R22	HL 1 - HL 3
Fire protection for rail vehicles (DIN EN 45545-2) R23	HL 1 - HL 3
Fire protection for rail vehicles (DIN EN 45545-2) R24	HL 1 - HL 3
Fire protection for rail vehicles (DIN EN 45545-2) R26	HL 1 - HL 3
Calorimetric heat release NFPA 130 (ASTM E 1354)	28 MJ/kg
Surface flammability NFPA 130 (ASTM E 162)	passed
Specific optical density of smoke NFPA 130 (ASTM E 662)	passed
Smoke gas toxicity NFPA 130 (SMP 800C)	passed

Electrical tests

Surge voltage test

Test voltage setpoint	9.8 kV
Result	Test passed

Temperature-rise test

Requirement temperature-rise test	Increase in temperature \leq 45 K
Result	Test passed
Short-time withstand current 70 mm ²	8.4 kA
Result	Test passed

Power-frequency withstand voltage

Test voltage setpoint	2.2 kV
Result	Test passed

Mechanical properties

Mechanical data

Open side panel	No
-----------------	----

Mechanical tests

High-current terminal block - UKH 70 BU



3244601

<https://www.phoenixcontact.com/de/produkte/3244601>

Mechanical strength

Result	Test passed
--------	-------------

Attachment on the carrier

DIN rail/fixing support	NS 32/NS 35
Test force setpoint	10 N
Result	Test passed

Test for conductor damage and slackening

Rotation speed	10 rpm
Revolutions	135
Conductor cross section/weight	25 mm ² / 4.5 kg
	70 mm ² /10.4 kg
	95 mm ² /14 kg
Result	Test passed

Environmental and real-life conditions

Needle-flame test

Time of exposure	30 s
Result	Test passed

Oscillation/broadband noise

Specification	DIN EN 50155 (VDE 0115-200):2008-03
Spectrum	Service life test category 1, class B, body mounted
Frequency	$f_1 = 5 \text{ Hz}$ to $f_2 = 150 \text{ Hz}$
ASD level	1.857 (m/s ²) ² /Hz
Acceleration	0.8g
Test duration per axis	5 h
Test directions	X-, Y- and Z-axis
Result	Test passed

Shocks

Specification	DIN EN 50155 (VDE 0115-200):2008-03
Pulse shape	Half-sine
Acceleration	5g
Shock duration	30 ms
Number of shocks per direction	3
Test directions	X-, Y- and Z-axis
Result	Test passed

Ambient conditions

Ambient temperature (operation)	-60 °C ... 105 °C (max. short-term operating temperature RTI Elec.)
Ambient temperature (storage/transport)	-25 °C ... 60 °C (for a short time, not exceeding 24 h, -60 °C to +70 °C)
Ambient temperature (assembly)	-5 °C ... 70 °C

High-current terminal block - UKH 70 BU



3244601

<https://www.phoenixcontact.com/de/produkte/3244601>

Ambient temperature (actuation)	-5 °C ... 70 °C
Permissible humidity (storage/transport)	30 % ... 70 %

Standards and regulations

Connection in acc. with standard	IEC 60947-7-1
----------------------------------	---------------

Mounting

Mounting type	NS 35/7,5
	NS 35/15
	NS 35/15-2,3
	NS 32

High-current terminal block - UKH 70 BU

3244601

<https://www.phoenixcontact.com/de/produkte/3244601>

Drawings

Schematic diagram

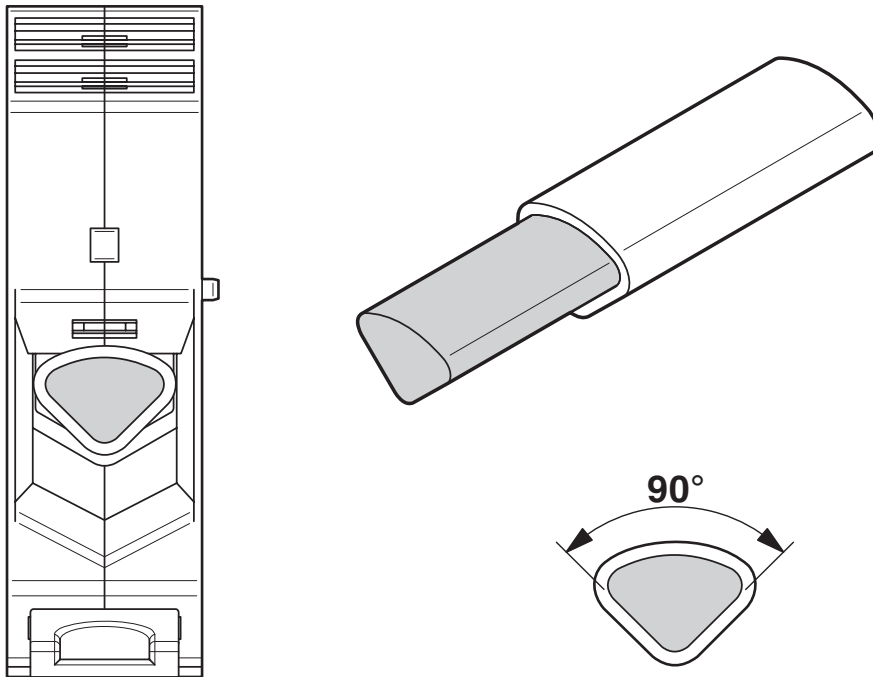

Connecting aluminum cables. Further notes can be found in the download area

Circuit diagram



High-current terminal block - UKH 70 BU



3244601

<https://www.phoenixcontact.com/de/produkte/3244601>

Approvals

DNV Approval ID: TAE00001CT				
	Nominal Voltage U_N	Nominal Current I_N	Cross Section AWG	Cross Section mm^2
			-	-

CSA Approval ID: 13631				
	Nominal Voltage U_N	Nominal Current I_N	Cross Section AWG	Cross Section mm^2
Use group B	1000 V	192 A	6 - 3/0	-
Use group C	600 V	192 A	6 - 3/0	-

CB IECEE CB Scheme Approval ID: DE1-62936				
	Nominal Voltage U_N	Nominal Current I_N	Cross Section AWG	Cross Section mm^2
	1000 V	192 A	-	- 70

EAC Approval ID: RU C-DE.BL08.B.00534				
--	--	--	--	--

cULus Recognized Approval ID: E60425				
	Nominal Voltage U_N	Nominal Current I_N	Cross Section AWG	Cross Section mm^2
Use group C	1000 V	192 A	6 - 3/0	-
Use group E	1000 V	192 A	6 - 3/0	-

LR Approval ID: LR2004271TA				
--------------------------------	--	--	--	--

VDE Zeichengenehmigung Approval ID: 40036368				
	Nominal Voltage U_N	Nominal Current I_N	Cross Section AWG	Cross Section mm^2
	1000 V	192 A	-	- 70

High-current terminal block - UKH 70 BU





3244601

<https://www.phoenixcontact.com/de/produkte/3244601>

 cUL Recognized Approval ID: E192998				
	Nominal Voltage U_N	Nominal Current I_N	Cross Section AWG	Cross Section mm^2
	880 V	192 A	6 - 3/0	-

 EAC Ex Approval ID: RU C-DE.HA91.B.00066				
--	--	--	--	--

 IECEX Approval ID: IECEX SEV12.0008U				
	Nominal Voltage U_N	Nominal Current I_N	Cross Section AWG	Cross Section mm^2
Mounting on NS 32	690 V	180 A	-	25 - 70
Mounting on NS 35	880 V	180 A	-	25 - 70

 UL Recognized Approval ID: E192998				
	Nominal Voltage U_N	Nominal Current I_N	Cross Section AWG	Cross Section mm^2
	880 V	192 A	6 - 3/0	-

 ATEX Approval ID: SEV12ATEX0168U				
	Nominal Voltage U_N	Nominal Current I_N	Cross Section AWG	Cross Section mm^2
Mounting on NS 32	690 V	180 A	-	25 - 70
Mounting on NS 35	880 V	180 A	-	25 - 70

 CCC Approval ID: 2020322313000623				
---	--	--	--	--

 NEPSI Approval ID: GYJ20.1195U				
--	--	--	--	--

 UKCA-EX Approval ID: CML 22UKEX1225U				
--	--	--	--	--

cULus Recognized				
-------------------------	--	--	--	--

High-current terminal block - UKH 70 BU



3244601

<https://www.phoenixcontact.com/de/produkte/3244601>

Classifications

ECLASS

ECLASS-9.0	27141120
ECLASS-10.0.1	27141120
ECLASS-11.0	27141120

ETIM

ETIM 8.0	EC000897
----------	----------

UNSPSC

UNSPSC 21.0	39121400
-------------	----------

High-current terminal block - UKH 70 BU



3244601

<https://www.phoenixcontact.com/de/produkte/3244601>

Environmental Product Compliance

China RoHS	Environmentally friendly use period: unlimited = EFUP-e No hazardous substances above threshold values
------------	---

Phoenix Contact 2023 © - all rights reserved
<https://www.phoenixcontact.com>

PHOENIX CONTACT Deutschland GmbH
Flachmarktstraße 8
D-32825 Blomberg
+49 52 35/3-1 20 00
info@phoenixcontact.de