



HEIDENHAIN



**Cables and
Connectors**

Precision encoders require reliable transmission between the encoder and the higher-level electronics. The connection technology of connectors and cables makes a decisive contribution here.

As accessories to the encoders, HEIDENHAIN supplies partially assembled, pre-assembled or non-assembled **cables** that optimized for the respective signal transmission—i.e. for certain interfaces. At the same time, special attention has been paid to the operating conditions. HEIDENHAIN cables are subjected to extensive system tests to ensure that they meet stringent requirements.

HEIDENHAIN **connecting elements** ensure permanent signal transmission with low transition resistance and continuous shielding. Their rugged and dense design makes them ideal for harsh operating conditions.



Comprehensive descriptions of all available interfaces as well as general electrical information are included in the *Interfaces for HEIDENHAIN Encoders* brochure, ID 1078628-xx.

This brochure supersedes all previous editions, which thereby become invalid. The basis for ordering from HEIDENHAIN is always the brochure edition valid when the order is made.

Standards (ISO, EN, etc.) apply only where explicitly stated in the brochure.

You can find more cables and connectors for controls in the OEM brochures on the respective controls.

Contents

Technical characteristics		
HEIDENHAIN cables and connectors	Areas of application	4
	Definition of HEIDENHAIN pre-assembled cables	5
General information	Durability and bending characteristics	6
	Use in drag chains	7
	Information on output cables	8
	General testing accessories for modular encoders and PWM 2x	9
Cable lengths		10
Connecting elements on HEIDENHAIN cables	Connector overview	13
Hybrid cable technology from HEIDENHAIN	Single-cable solution for servo drives	16
Cable overviews		
	Notes on cable overviews	18
	Legend to the cable overviews	20
	Adapter cables and connecting cables	21
	Output cable	45
Cable list		
	Notes on the cable list	50
	Cable list sorted by part number (ID)	51
	Signal cable	77
Connecting elements		
Connecting elements	M8, M12, and M23 connecting elements	78
	Sub-D and HMC 6 connecting elements	80
Pin layouts		82

HEIDENHAIN cables and connecting elements

Areas of application

HEIDENHAIN cables and connectors in conjunction with the respective encoders are used in a wide range of industrial production, in medical technology, in measuring technology laboratories, and in positioning devices. The requirements for the cables vary according to the application:

Machine tools

- Resistant to media
- Suitable for drag chains
- Can be connected the encoder for easy exchange
- Simple configuration

Electronics industry

- Low bend radius
- High bending frequency
- Low required bending force

Metrology

- Low required bending force
- Easy to configure

Automation technology

- Large cable lengths
- Easy to configure
- High bending frequency
- Compact connecting elements

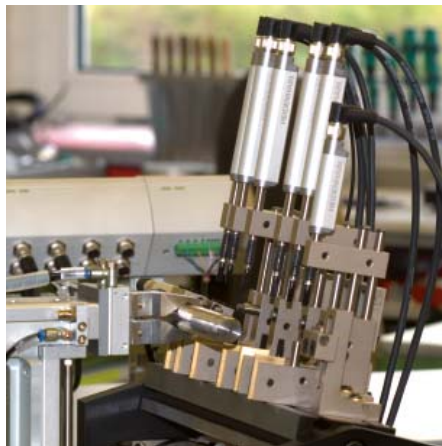
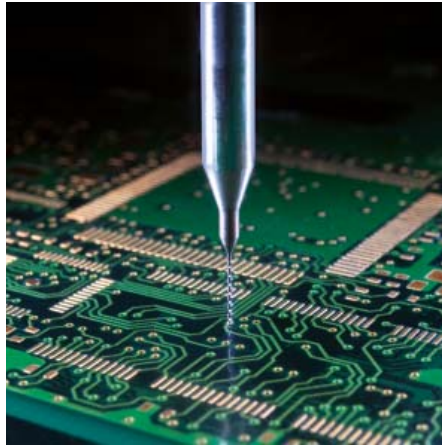

HEIDENHAIN connectors and cables are specially designed to meet the requirements of the application areas. Comprehensive inspections test both their functionality and durability.

The advantages of HEIDENHAIN cables and connecting elements at a glance:

Connecting elements

- Low transition resistance
- Safe shield connection
- Complete shielding
- Corrosion-free contacts
- Reliable contact closure
- Long-term stability

Cable

- Low crosstalk
- Good shield coverage
- Small bend radius
- Suitable for use in drag chains
- Resistant to media
- Mechanically rugged
- Adapted wire cross section
- Resistant to aging

Definition of HEIDENHAIN pre-assembled cables

“Pre-assembled cable” is a hypernym for insulated electrical conductors to which devices such as controls and encoders can be connected. Depending on which connecting elements are located at the ends, pre-assembled cables are divided into connecting, adapter and output cables.

VBK = connecting cable



Cables that use the same connecting element type at both ends and cables with a free cable end are referred to as connecting cables. This applies irrespective of whether they are connectors or couplings, or in male or female versions, i.e. also for cables that serve the as extensions.

Example

M12 connector, 8-pin with female contacts on M12 coupling, 8-pin with male contacts.



APK = adapter cable



Cables that use different connecting elements at each end are referred to as adapter cables.

Example

M12 connector, 8-pin with female contacts on D-sub, 15-pin with male contacts.



AGK = output cable



Output cables are assemblies that allow direct connection to the PCB connector of the encoder and then lead to other connecting element systems or to a free cable end.

Example

Rotary encoder cable assemblies inside motors, transmission from PCB connectors to angle flange sockets M23, 9-pin.



General information

Durability and bending properties

Versions

The output cables of almost all HEIDENHAIN encoders as well as the adapter cables and connecting cables have a **polyurethane (PUR)** jacket. Further materials used are **special elastomer (EPG)**, **special thermoplastic (TPE)** and **polyvinyl chloride (PVC)**. These cables are identified in the brochure as PUR, EPG, TPE or PVC.

Durability

PUR cables are resistant to oil and hydrolysis and microbes in accordance with DIN EN 60811-2-1 and resistant to microbes in accordance DIN EN 50363-10-2. They are free of PVC and silicone and comply with UL safety directives. The NRTL certification **AWM STYLE 20963 80 °C 30 V E63216 is documented on the cable.**

EPG cables are suitable for high temperatures and are resistant to oil in accordance with DIN EN 60811-2-1, hydrolysis in accordance with DIN EN 50363-10-2, and are free of PVC and silicone. The jacket is free of halogen. In comparison with PUR cables, they are only somewhat resistant to media, frequent flexing and continuous torsion.

PVC cables are oil resistant. The NRTL certification is documented on the cable with AWM E64638 STYLE20789 105C VW-1SC NIKKO.

TPE wires in netting or shrink tubing are suitable for higher temperature ranges and low bending radii, but low oil resistance.

Bending characteristics

Temperature range*

	Rigid configuration	Frequent flexing
PUR	-40 °C to 80 °C	-10 °C to 80 °C
EPG	-40 °C to 120 °C	-
TPE	-40 °C to 120 °C	-
PVC	-20 °C to 90 °C	-10 °C to 90 °C

* Values may vary in individual cases

Some PUR cables can be used at temperatures up to 100 °C provided there hydrolysis and media loading are limited. If you need assistance, please contact HEIDENHAIN.

The **bend radii** of cables differ depending on whether the cable is in a rigid configuration or subjected to frequent flexing (e.g. in a drag chain). The minimum permissible bend radius depends on the cable diameter and cable jacket.

The **flexing frequency** of HEIDENHAIN cables is tested in continuous tests.

The **bending force** is crucial in applications in which no external force is permitted (e.g. extremely fast or high-accuracy positioning tasks). The cable connecting the stationary and the moving part must therefore be highly flexible to prevent any deformation of the measuring setup due to the bending force of the cable. HEIDENHAIN supplies suitable, extremely thin cables with a sufficiently low bending force for frequent flexing.

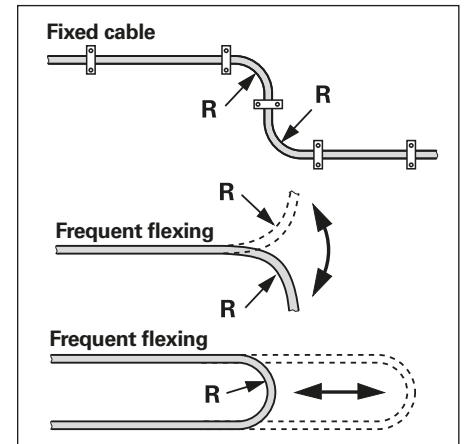

Cable	Material	Bend radius R at 20 °C	
		Rigid configuration	Frequent flexing
Ø 3.7 mm	EPG	≥ 10 mm	-
Ø 3.7 mm	PUR	≥ 8 mm	≥ 40 mm
Ø 4.3 mm		≥ 10 mm	≥ 50 mm
Ø 4.5 mm			
Ø 4.5 mm	EPG	≥ 18 mm	-
Ø 5.1 mm	PUR	≥ 10 mm	≥ 50 mm
Ø 5.5 mm	PVC	Upon request	Upon request
Ø 6 mm	PUR	≥ 20 mm	≥ 75 mm
Ø 6.8 mm			
Ø 8 mm		≥ 40 mm	≥ 100 mm
Ø 10 mm ¹⁾		≥ 35 mm	≥ 75 mm
Ø 14 mm ¹⁾		≥ 100 mm	≥ 100 mm
6 or 8 TPE wires in netting or shrink tubing	TPE	≥ 10 mm	-
2 TPE wires in shrink tubing		≥ 3 mm	-
2 TPE wires in shrink tubing	Polyefin in net sleeve	≥ 5 mm	-

¹⁾ Metal armor

Use in drag chains

Encoder cables in drag chains

Encoder cables from HEIDENHAIN are suitable for drag chains when routed according to the specifications. They have a typical service life of five to ten million cycles. Compliance with the drag chain manufacturer's routing instructions and the routing information provided below is essential for the duration of the service life. Incorrect routing or non-compliance with the routing instructions can significantly reduce the service life of the cables.

Information for routing in drag chains

When used in drag chains, encoder cables are subjected to extremely high mechanical loads. The higher the traversing speed or number of cycles, the more stringently the routing instructions must be adhered to.

Routing information for the cable arrangement:

- Cables should be laid individually. As this is not always possible due to lack of space, cables with identical or similar cross sections can be routed next to each other in one compartment. Vertical or horizontal separators are required for cables that differ very much in diameter or consist of different materials.
- The cables must be prevented from shifting on top of each other. To ensure this, the clearance height of a compartment within the drag chain must not be more than half of the cable diameter.
- The space provided for the cables must be at least 10 % to 20 % of the cable diameter. This ensures that the cables can move as required.

General routing information:

- The cables must be routed without twists. Unwind cables from drums or rings beforehand
- The cables must be able to move freely within the chain radius. Do not lay the cables too tightly together or over an excessive distance
- Provide strain relief on both ends of each cable. Be sure to clamp it over a large area
- The weight should be distributed as evenly as possible in relation to the chain width

Routing information for bend radii:

- The minimum permissible bend radius of the chain is defined by the permissible bend radius of all cables
- If the bend radius is larger than the minimum bend radius of the cable, this has a positive influence on the service life of the cable. The bend radius should thus be chosen correspondingly

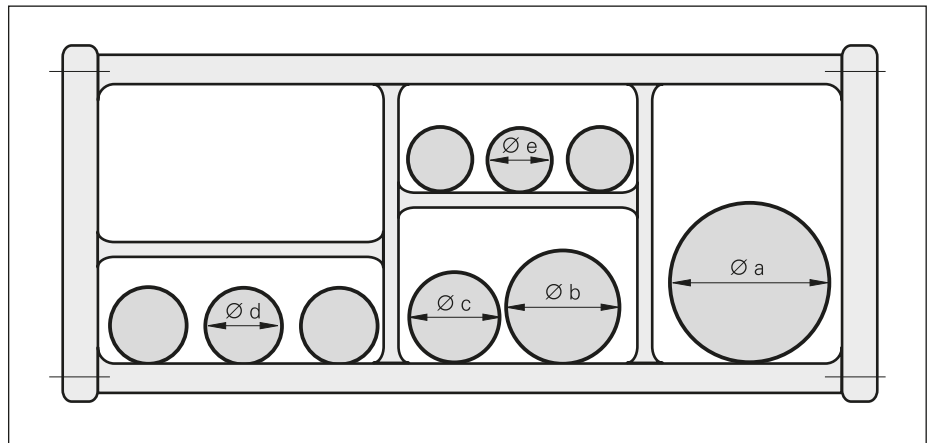

Arrangement of a drag chain with cables of different diameters ($\varnothing x$)

Information on output cables

Mounting and initial operation is permissible only with appropriate ESD protection. Do not engage or disengage any connections while under power. To avoid overstressing the individual wires when disengaging a connector, HEIDENHAIN recommends using the mounting aid to pull the PCB connector.



Mounting aid for PCB connector

Screws

For output cables with standard M12 or M23 flange sockets, M2.5 screws are to be used.

The M2.5 screws are to be fastened with the following torques:

For M12, M23	M_d min.	0.4 Nm
	M_d max.	0.5 Nm
Load-bearing thread length		Min. 4 mm
Minimum tensile strength of screws		800 N/mm ²

To prevent the screws from spontaneously loosening, HEIDENHAIN recommends using a materially bonding threadlocker.

Cable length (rated length)

For output cables with crimping on the encoder side for strain relief and shield contact, the cable length up to the crimp sleeve is indicated.

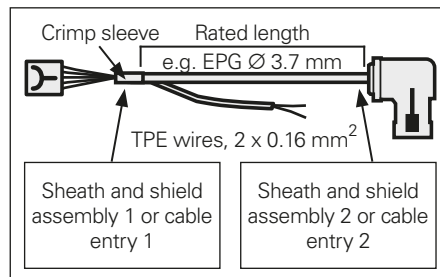

For standard output cables, the rated wire length for temperature sensors is the same as the rated cable length.

Exceptions include output cables without crimping on the encoder side or with shield connection clamp. You can receive authorized information (dimension drawing) on request by providing the proper output cable ID number (see *Cable list*).

Electromagnetic compatibility

Cables from HEIDENHAIN are tested for electromagnetic compatibility. For output cables with wires for temperature sensors, CE conformity must be demonstrated in the overall system.

Crimp connector

For crimping the wires of the output cable for the temperature sensor with the wires of temperature sensor in the motor. ID 1148157-01

You will find information on the fitting crimp tools in the Product Information document for the *HMC 6*.

Strain relief

Avoid torque or tensile stress, use strain relief if necessary.

M12 flange socket, radial

Retention force of polarizing key: max. 1 Nm

Accessory

Mounting aid for disengaging the PCB connector. Suitable for all rotary encoders for servo motors, except the ERO 1200 series ID 1075573-01

To avoid damage to the cable, the pulling force must be applied only to the connector, not to the wires.

General testing accessories for modular encoders and PWM 2x

Testing cable for modular rotary encoders with EnDat22, EnDat01 and SSI interface

Includes three 12-pin adapter connectors and three 15-pin adapter connectors
ID 621742-01

Adapter connectors

Three connectors for replacement
12-pin: ID 528694-01
15-pin: ID 528694-02

Connecting cables

For extending the testing cable.
Complete with D-sub connector, male, and D-sub connector, female, both 15-pin (max. 3 m)
ID 1080091-xx

Testing cable for ERN 138xx with commutation signals for sinusoidal commutation

Includes three 14-pin adapter connectors
ID 1118892-02

Adapter connectors

Three connectors for replacement
14-pin: ID 528694-04

Connecting cables

For extending the testing cable.
Complete with D-sub connector, male, and D-sub connector, female, both 15-pin (max. 3 m)
ID 675582-xx

Adapter cable for connecting the flange socket with the motor with the PWM 2x

EnDat22 interface

Adapter cable Ø 6 mm

M23 connector, female, 9-pin
M12 coupling, male, 8-pin
ID 1136863-xx
(In addition, ID 524599-xx M12, female, needed on D-sub connector, male, 15-pin)

Adapter cable Ø 6 mm/8 mm

M12 connector, female, 8-pin
D-sub connector, male, 15-pin
ID 1036526-xx Ø 6 mm
ID 1129753-xx Ø 8 mm

DRIVE-CLiQ interface

Adapter cable Ø 6.8 mm

M23 connector, female, 9-pin
Ethernet connector (RJ45) with IP20 metal housing, 6-pin
ID 1117540-xx

Adapter cable Ø 6.8 mm

M12 connector, female, 8-pin
Ethernet connector (RJ45) with metal housing IP20, 6-pin
ID 1093042-xx

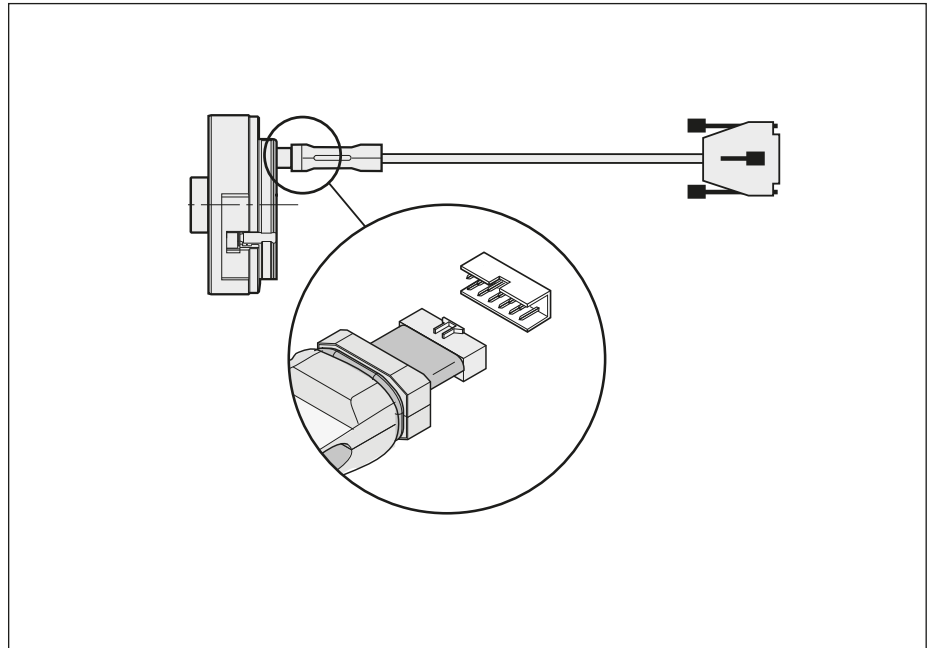

Testing cables for modular rotary encoders

EnDat01, EnDat Hx, EnDat Tx or SSI interface with incremental signals

Adapter cable Ø 8 mm

M23 connector, female, 17-pin
D-sub connector, male, 15-pin
ID 324544-xx

Adapter cable Ø 8 mm

M23 connector, female, 12-pin
D-sub connector, male, 15-pin
ID 310196-xx

Version for HMC 6

Adapter cable Ø 13.6 mm

M23 SpeedTEC hybrid connector, female, five power wires, two brake wires, six communication wires
D-sub connector, male, 15-pin
ID 1189174-xx

DRIVE-CLiQ is a registered trademark of SIEMENS AG.

SpeedTEC is a registered trademark of TE Connectivity Industrial GmbH.

Cable lengths

Maximum cable lengths

The cable lengths listed in the brochure *Interfaces of HEIDENHAIN Encoders* apply only for HEIDENHAIN cables and the recommended input circuitry of subsequent electronics.

The maximum achievable cable length is significantly limited by the following factors:

- Compliance with the supply voltage at the encoder
- Influence of the supply voltage from the subsequent electronics
- Restrictions resulting from the transmission technique (e.g., protocol design for purely serial interfaces, manufacturer specifications for proprietary interfaces)

Please note: These restrictions must be independently checked and complied with.

Compliance with the supply voltage at the encoder

The interfaces of HEIDENHAIN encoders permit large cable lengths of up to 150 m. With large cable lengths, voltage falls significantly in the supply lines. The voltage drop is influenced by the cable length, the current consumption of the encoder, and the wire cross-section of the supply lines.

Particularly with large cable lengths and encoders with high current requirements, such as absolute linear and angle encoders, the voltage drop might cause the signal to fail to comply with the minimum permissible supply voltage. The highest possible supply voltage U_P should therefore be selected in the subsequent electronics. The voltage drop can be mitigated by the following measures:

- Keep thin cables with small wire cross-sections, as short as possible
- For large cable lengths, use a larger wire cross section
- For subsequent electronics without a variable power supply, use the sensor lines as additional supply lines. This doubles the available cross-section.

For more information, refer to the *Interfaces of HEIDENHAIN encoders* brochure.

Data transfer technology

The transmission characteristics of the cables, protocol properties of the interfaces and other specifications impose limitations on the design of the cable lengths.

Purely serial interfaces with transmission frequencies up to 16 MHz in combination with large cable lengths place high technological demands on the cable. Thanks to a cable design specifically adapted to these applications, HEIDENHAIN cables are ideally suited to these requirements. HEIDENHAIN therefore recommends using original HEIDENHAIN cables.

An adapter cable connected directly to the encoder is limited in length. To realize larger cable lengths, an adapter cable and an additional connecting cable with a larger cross-section can be used.

Lengths of pre-assembled cables

The maximum total cable length is given in the table below.

EnDat 2.2	100 m
DRIVE-CLiQ	100 m
Fanuc, Panasonic	30 m ¹⁾
Mitsubishi, Yaskawa	30 m
EnDat 2.1	150 m
SSI	100 m
1 V _{PP}	150 m
11 μA _{PP}	30 m
TTL	100 m

¹⁾ Lengths up to 50 m are possible depending on the encoder

Further information, especially on the TTL and EnDat interfaces, can be found in the brochure *Interfaces*. Please refer to the *Specifications* of the respective encoder.

The following restrictions must be observed depending on the interface and the cable diameter:

EnDat 2.1, SSI, 1 V_{PP} TTL interfaces:

- Adapter cables are possible for connection at the encoder for up to 9 m cable length

EnDat 2.2, Fanuc, Mitsubishi, Panasonic, Yaskawa purely serial interfaces:

In order to meet the increasing demands on transmission technology in the future, suitable cables have been introduced for purely serial interfaces. These cables have the following essential advantages over the previously used cables:

- Optimized transmission characteristics for future requirements
- Optimized suitability for use in drag chains

In order to achieve these properties, the cross sections of the wires in the cable and the cable design were adapted. Particularly for large cable lengths, the change in the cross sections of the supply conductors must be taken into account in the design phase.

The cable overview illustrates the difference between the new cables and the cables used up to now. The cables used so far are marked "Do not use for new applications".

The diameter of the adapter cables and connecting cables is decisive for the maximum cable length (see *Figure 1*). For adapter cables and connecting cables in the "Do not use for new applications" versions, separate restrictions apply for the maximum cable length (see *Figure 2*).

A major factor influencing the achievable maximum cable length is the supply voltage of the subsequent electronics. The value of 4.9 V selected in the table represents the lower limit of the supply voltage of commercially available subsequent electronics. The table shows example combinations of lengths of the adapter cable (Ø 4.5 mm) for various encoders and the resulting maximum cable length of the connecting cable. The values in the table apply to a parallel connection of the sensor lines and the supply lines. The attainable total length is the sum of the lengths of the adapter cable and connecting cable.

The overall lengths of 30 m used today can be achieved without restrictions. For larger overall lengths, connecting cables with a larger cross section are to be used or, if possible, the supply voltage of the subsequent electronics U_P should be increased.

Device	Power consumption at $U_P = 3.6V$ or $14V$	Adapter cable $\varnothing 4.5$ mm $A_P = 2 \times 0.16$ mm ²	Cable $\varnothing 6$ mm $A_P = 2 \times 0.16$ mm ²	Cable $\varnothing 8$ mm $A_P = 2 \times 0.35$ mm ²	
LC RCN ROC	$3.6V \leq 1100$ mW $14V \leq 1300$ mW	20 m 6 m 1 m	15 m 29 m 34 m	35 m 66 m 77 m	
ECN 1325	$3.6V \leq 600$ mW $14V \leq 700$ mW	0.3 m	Output cable inside the motor housing	65 m	
EQN 1337	$3.6V \leq 700$ mW $14V \leq 800$ mW	0.3 m			55 m
AK LIC 41x	$3.6V \leq 950$ mW $14V \leq 1050$ mW	3 m 1 m	Output cable on the encoder	37 m 39 m	85 m 89 m

Maximum cable length for purely serial interfaces (determined with a supply voltage of 4.9V DC)

Remarks:

- The values apply for $U_P = 4.9V$ supply voltage for the subsequent electronics
- The information is not valid for cables of the "Do not use for new applications" version
- Cable length may be limited depending on the interface design of the encoder, (see the data in the brochure of the respective encoder, maximum value = 100 m)
- Values for power consumption are listed in the brochure edition *Cables and Connecting Elements*. For the latest values of power consumption, please refer to the specifications of the respective product brochure
- Please also observe the subsequent-electronics manufacturer's instructions for the supply voltage to the encoder and maximum permissible cable lengths

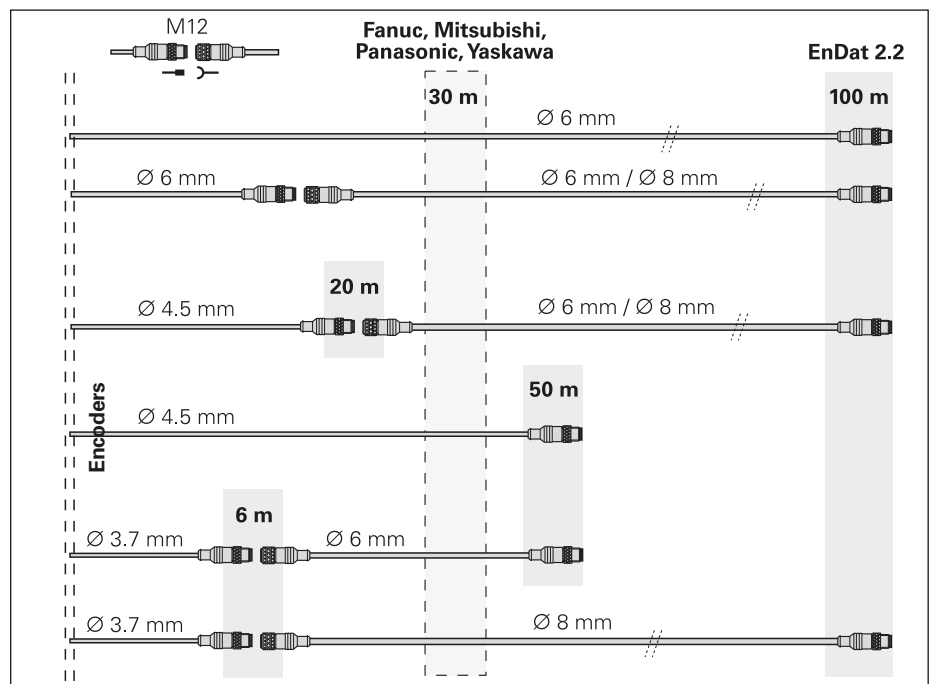

Figure 1: New cables for purely serial interfaces

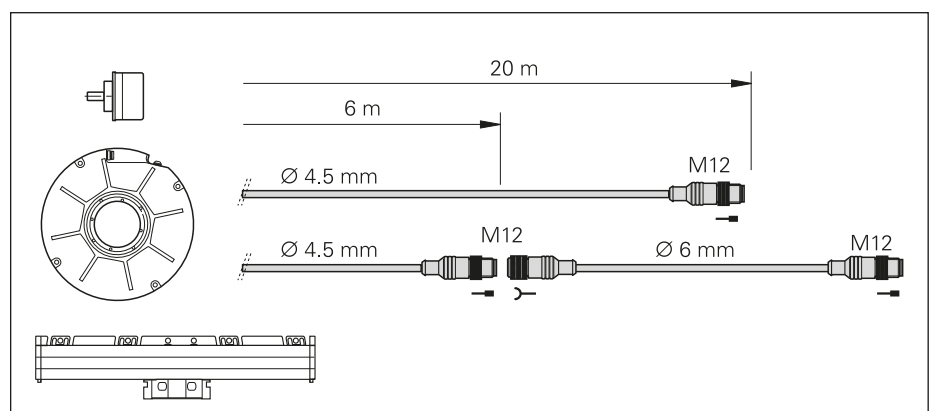

Figure 2: Cable length for the "Do not use for new applications" versions

DRIVE-CLiQ interface:

DRIVE-CLiQ does permit a maximum cable length of 100 m, but this value is reduced by a number of influencing factors:

- Number of joints with DRIVE-CLiQ couplings
- Length factor of the cables
- Pluggable cable at the HEIDENHAIN encoder
- Length of the HEIDENHAIN cable with compensation factor
- Output cable (AGK)

Encoders connected through an output cable (AGK) have an additional length limitation. Due to the transmission characteristics of the output cable (AGK) the limit value of 40 m applies to the formula for calculating the maximum permissible cable length.

This limitation applies to all output cables (AGK) that are marked with "DQ01" in the "Use with" column according to the cable overview list.

Note

Further length restrictions may apply, depending on the encoder. For more information see the brochure or product information document of the respective encoder.

Permissible cable length for DRIVE-CLiQ

The maximum permissible cable length is calculated as follows:

$$n_{MG} \cdot 5 \text{ m} + \frac{4}{3} \cdot L_{AC} + \sum_i k_i \cdot L_i + n_C \cdot 5 \text{ m} \leq 100 \text{ m}$$

k_i : Length compensation factor¹⁾ of the signal line i (4/3 for cables from HEIDENHAIN)

L_i : Total length¹⁾ of the signal line i

n_C : Number of joints

n_{MG} : Influence of the encoder, e.g. by a pluggable adapter cable; $n = 1$

4/3: Length compensation factor for HEIDENHAIN cables

L_{AC} : Length of the HEIDENHAIN cable

¹⁾ See the technical documentation of the subsequent electronics manufacturer

Connecting elements on HEIDENHAIN cables

Overview of connecting elements

Connecting elements are divided into:

Connectors
(with coupling ring)

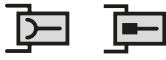

Couplings
(with external thread)



Please note: When tightening the M12 connectors, maintain a torque of 0.6 Nm to 0.8 Nm. A torque wrench (commercially available) is separately available. The cable with M12 connector (female) is provided

with an insulator that prevents contact with other electrically conductive parts. After screwing the connecting element, the insulator must be inserted so that the inside wall lies between the knurled nuts.

Connector (insulated): Connecting element with coupling ring

M12

M23

M12 right-angle connector

Quick connector
M12, on adapter cable

* Cable fastening

Compact connector with push/pull lock

M12 right-angle connector (with lock)

Coupling (insulated): Connecting element with external thread

M12

M23

Coupling on adapter cable

M12, 14-pin

Mounted coupling with flange

M23

Mounted coupling with central fastening

M23

HMC 6

Flange socket

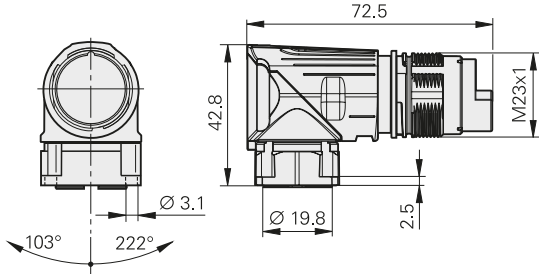

Required mating dimensions for flange socket

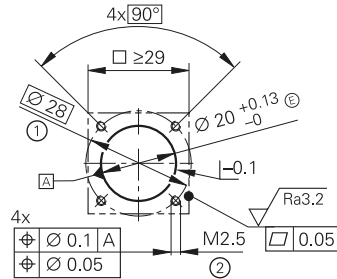

- ① = Bolt circle diameter
 ② = At least 4 mm of load-bearing thread length

Connector

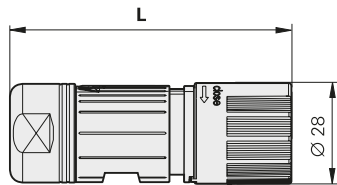

	L
Ø 9.5 mm – Ø 14.5 mm	78
Ø 14 mm – Ø 17 mm	80.5

Coupling

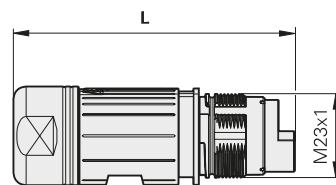

	L
Ø 9.5 mm – Ø 14.5 mm	78
Ø 14 mm – Ø 17 mm	80.5

D-sub connector for HEIDENHAIN controls and evaluation electronics

Symbols

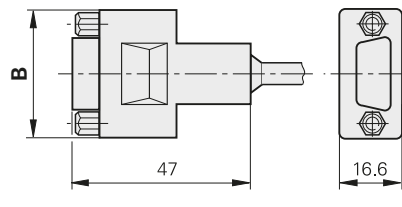
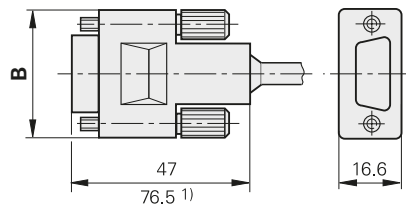

1) Interface electronics integrated in connector

Number of pins	B
9	35
15	43
25	56

The **pin numbering** on connectors is in the direction opposite to those on couplings or flange sockets, regardless of whether the connecting elements have

male contacts or



female contacts.



When engaged, the connections provide **protection** to IP67 (D-sub connector: IP50; EN 60529). When not engaged, there is no protection.

Accessories for flange sockets and M23 mounted couplings

Threaded metal dust cap

ID 219926-01

Gasket

ID 266526-01

mm



Tolerancing ISO 8015

ISO 2768 - m H

≤ 6 mm: ±0.2 mm

Hybrid cable technology from HEIDENHAIN

Single-cable solution for servo drives

Motors normally need two separate cables:

- One cable for the motor encoder
- One cable for the motor power supply

With its Hybrid Motor Cable **HMC 6**, HEIDENHAIN has integrated the encoder lines in the power cable. So now only **one cable** is needed between the motor and electrical cabinet.

The HMC 6 single-cable solution has been specially conceived for the HEIDENHAIN **EnDat 2.2** interface with purely serial transmission (ordering designation: EnDat22) over cable lengths up to 100 m. However, all other encoders with purely serial RS-485 interface can also be connected. This makes a broad range of encoders available without having to introduce a new interface. Rotary encoders in buffer battery backup are in preparation.

The HMC 6 integrates the lines for encoders, motors and brakes in only one cable. It is connected to the motor via a special connector. For connection to the inverter, the cable is split into power connections and an encoder connector. This makes it compatible on the control side with all the same components as conventional cables.

If the components are correctly mounted, the connections will have the IP67 degree of protection. Vibration protection against loosening of coupling joints is integrated in the connector, as also is the quick-release lock.

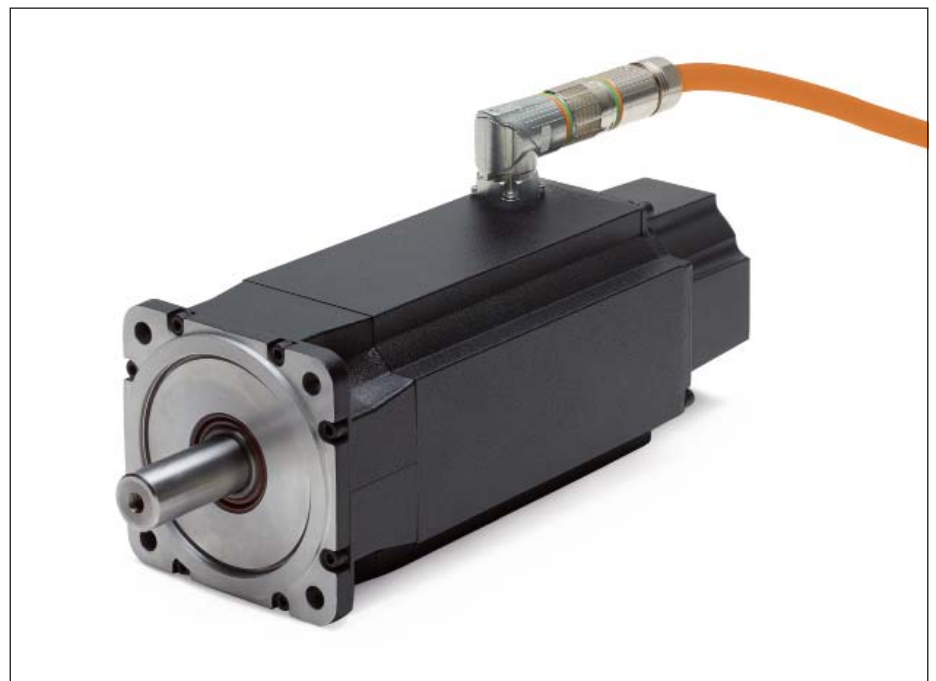
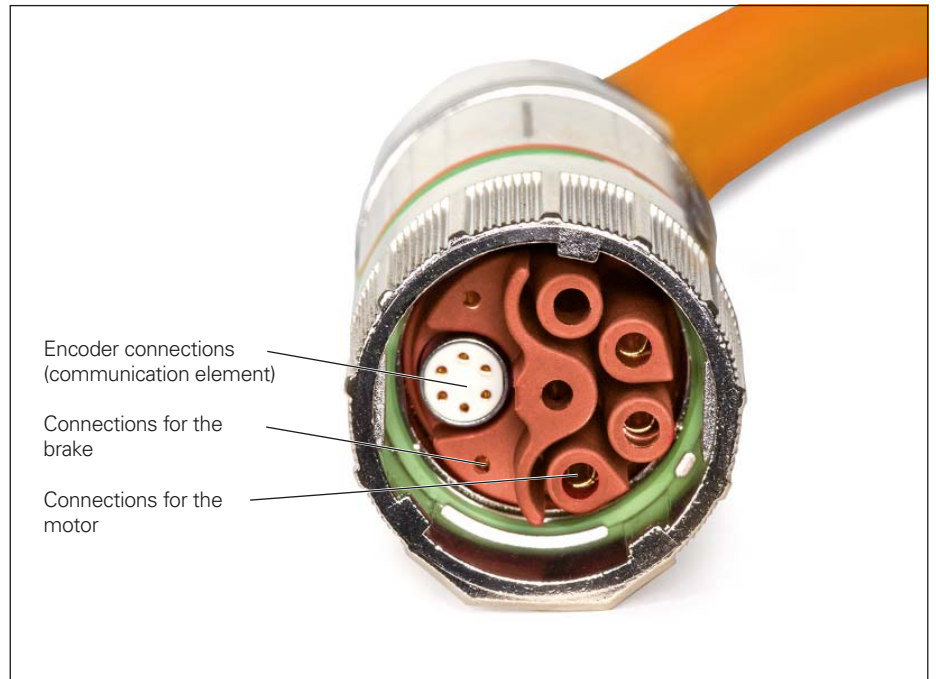

Advantages

The HMC 6 single-cable solution offers a series of cost and quality improvements both for the motor manufacturer and the machine tool builder:

- No need to replace existing interfaces
- Allows more compact drag chains
- A smaller number of cables significantly improves drag chain flexibility
- A wide range of encoders is available for HMC 6 transmission
- There is no assignment of cable contacts in the machine
- Reduces mechanical requirements (flange socket on the motor, cable ducts in the machine housing)
- Lower shipping and storage costs for cables and connectors
- Installation is simpler and faster
- Lower cost of documentation
- Fewer service components are required
- The contour including the cable is smaller, making it easier to integrate the motor in the machine housing
- The combination of power cable and encoder cable has been tested by HEIDENHAIN

The universal design of the HMC 6 provides you—as motor manufacturer or machine tool builder—with the greatest possible flexibility, because you can use standard components—both on the motor and the control side.

A special advantage: **all HEIDENHAIN encoders with EnDat interface** (ordering designation EnDat22) or with purely serial data transfer as per RS-485 are suited for the HMC 6 single-cable solution. They include motor encoders for servo drives in their various sizes, as well as linear and angle encoders used in direct drives. Encoders for **functional safety** up to SIL 3 are, of course, also included. Rotary encoders with buffer battery backup are in preparation.

But there is no need for extra costs on the control side either: you can use the same inverter systems or controller units as before. The HMC 6 cable has been designed to be easy for you to wire it to the proper connector systems. And most importantly: there is no reduction in noise immunity.



Components

You only need a few components to make your motor ready for the single-cable solution.

Connecting element on the motor

The motor housing is equipped with a special angle flange socket. This angle flange socket brings together the wires for the encoder, motor power and brake are brought together.

Crimp tools for the power lines

The crimp contacts for power and brake wires are assembled using the usual tools.

Cables inside the motor housing

The rotary encoder is connected through the output cable inside the motor: your ready-wired communication element is simply latched to the angle flange socket.

Cable with hybrid connector

Besides the wires to the encoder, the HMC connecting cable with the motor also includes those for the motor power and brake. It is assembled at one end with a hybrid connector

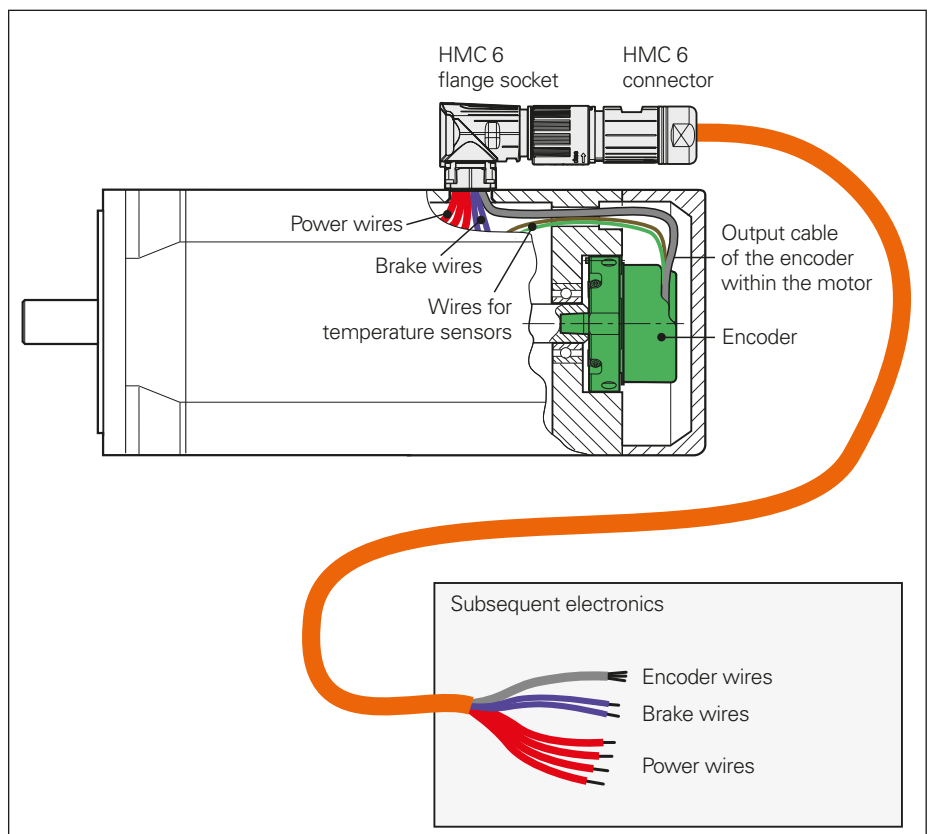

You can find more information on the HMC 6 in the *HMC 6 Product Information* document.

Cable overviews

Notes on the cable overviews

Layout of cable overviews

The cable diagrams show devices with their cables to the subsequent electronics on the left side. In the middle, various connecting elements or interface

electronics can be used. Subsequent electronics are listed on the right side. They are grouped by pin layout and differentiated by their connecting element.

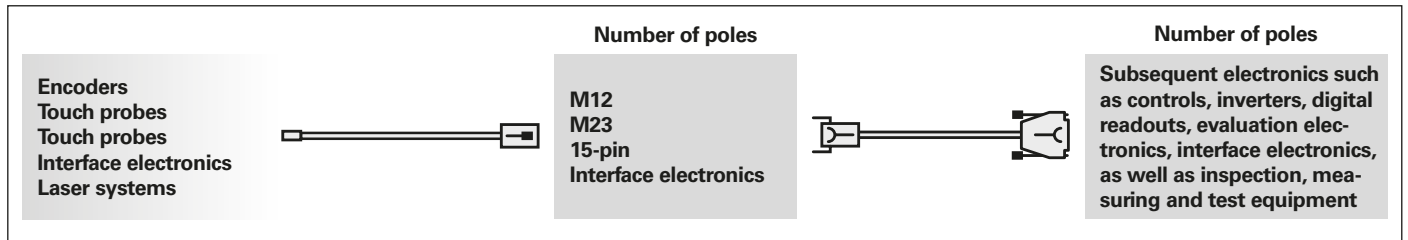

Schematic representation of cable overviews

Example of a cable configuration:

Connection of an RCN with a TNC in a machine tool under the following conditions:

- RCN 5310:
 - EnDat 2.2 interface
 - Ordering designation EnDat22
 - Power consumption P_M max. 1100 mW with $U_P = 3.6 V$, 1300 mW with 14 V
- Adapter cable (APK) for connection to the encoder: Length 3 m; $\varnothing 4.5$ mm
- M12 connecting element in transition to the drag chain
- Adapter cable (APK) to the control: Length 40 m
- TNC 640:
 - Encoder input, D-sub, 15-pin
 - Supply voltage U_E min. 4.9 V
 - Sensor lines are used for additional supply

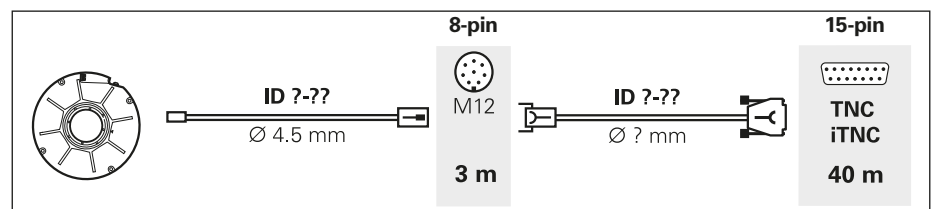





The following example shows the use of the cable overviews, cable list and pin layouts.

Select the appropriate cable overview using the desired interface as well as the ordering designation of the encoder.

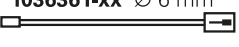
“Adapter cables and connecting cables for EnDat interface (EnDat22)”

Determine the part number of the cable (in some cases, multiple part numbers are possible). Pay attention to the correct cable configuration, the connecting element and the number of pins!

<p>RCN 2x10 RCN 5x10 RCN 8x10</p>	<p>729681-xx Ø 4.5 mm 1036361-xx Ø 6 mm</p> 	<p>8-pin</p>  <p>M12</p>	<p>APK on RCN with M12 coupling: 729681-xx (Ø 4.5 mm required)</p>
<p>8-pin</p>  <p>M12</p>	<p>1036521-xx Ø 6 mm 1130994-xx Ø 8 mm</p> 	<p>15-pin</p>  <p>TNC iTNC</p>	<p>APK to TNC (15-pin) with M12 connector: 1036521-xx (Ø 6 mm) or 1130994-xx (Ø 8 mm)</p>

Determine the permissible cable lengths for signal transmission (see *Cable lengths*). Observe restrictions on the adapter cable for connection to the encoder!

EnDat 2.2 Interface:
3 m APK Ø 4.5 mm on RCN ≤ 20 m ✓
43 m total length ≤ 100 m ✓

To calculate the voltage drop, determine the cross section of the supply wires in the cable list using the selected part numbers.

729681-xx and 1036521-xx: $2 \times 0.16 \text{ mm}^2$
1130994-xx: $2 \times 0.35 \text{ mm}^2$

Check compliance of the supply voltage. Particularly for encoders with an extended supply voltage range, use the calculation steps from the *Interfaces of HEIDENHAIN Encoders* brochure. Each combination of cables must be calculated separately.

The maximum current consumption of the RCN and the maximum permissible voltage drop are obtained from the information on the encoder and control:
 $\Delta U_{\text{max}} = U_E - U_P = 4.9 \text{ V} - 3.6 \text{ V} = 1.3 \text{ V}$

3 m APK 729681-xx and 40 m APK 1036521-xx: $\Delta U = 1.7 \text{ V}$; ✗ (value too high)
3 m APK 729681-xx and 40 m APK 1130994-xx: $\Delta U = 0.7 \text{ V}$; ✓





Check the pin layout. In the *Pin layouts* section they are assigned by their own numbers to a subsequent electronics unit or a connecting element.

② **15-pin**



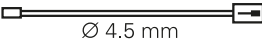

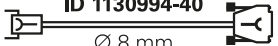





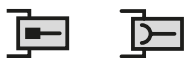



TNC
iTNC
(SMC 40)

For the 15-pin D-sub connector there are two versions, see figure below. In this example, the fitting layout is the number “2” for the TNC.

Results of the cable determination

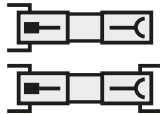
	<p>ID 729681-03</p>  <p>Ø 4.5 mm</p>	<p>8-pin</p>  <p>M12</p> <p>3 m</p>	<p>ID 1130994-40</p>  <p>Ø 8 mm</p>	<p>15-pin</p>  <p>TNC iTNC</p> <p>40 m</p>
---	--	---	---	---

Cable overview legend

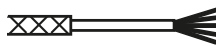
	Connector, male/female		D-sub connector, male/female
	Coupling, male/female		Sub-D connector with locking screws, male/female
	Mounted coupling with flange, male/female		D-sub connector, male (interface electronics integrated in connector)
	Flange socket, male/female		Fanuc connector, male/female Mitsubishi connector, male/female Panasonic connector, male/female
	Angle flange socket, male		Push-pull connector
	Adapter connector, male/female		Push-pull flange socket
	PUR cable		
	PUR cable in metal armor		
	Cable with braided shield		
	PUR cable in metal armor and steel wire sheathing		

Adapter cables and connecting cables – EnDat interface (EnDat22)

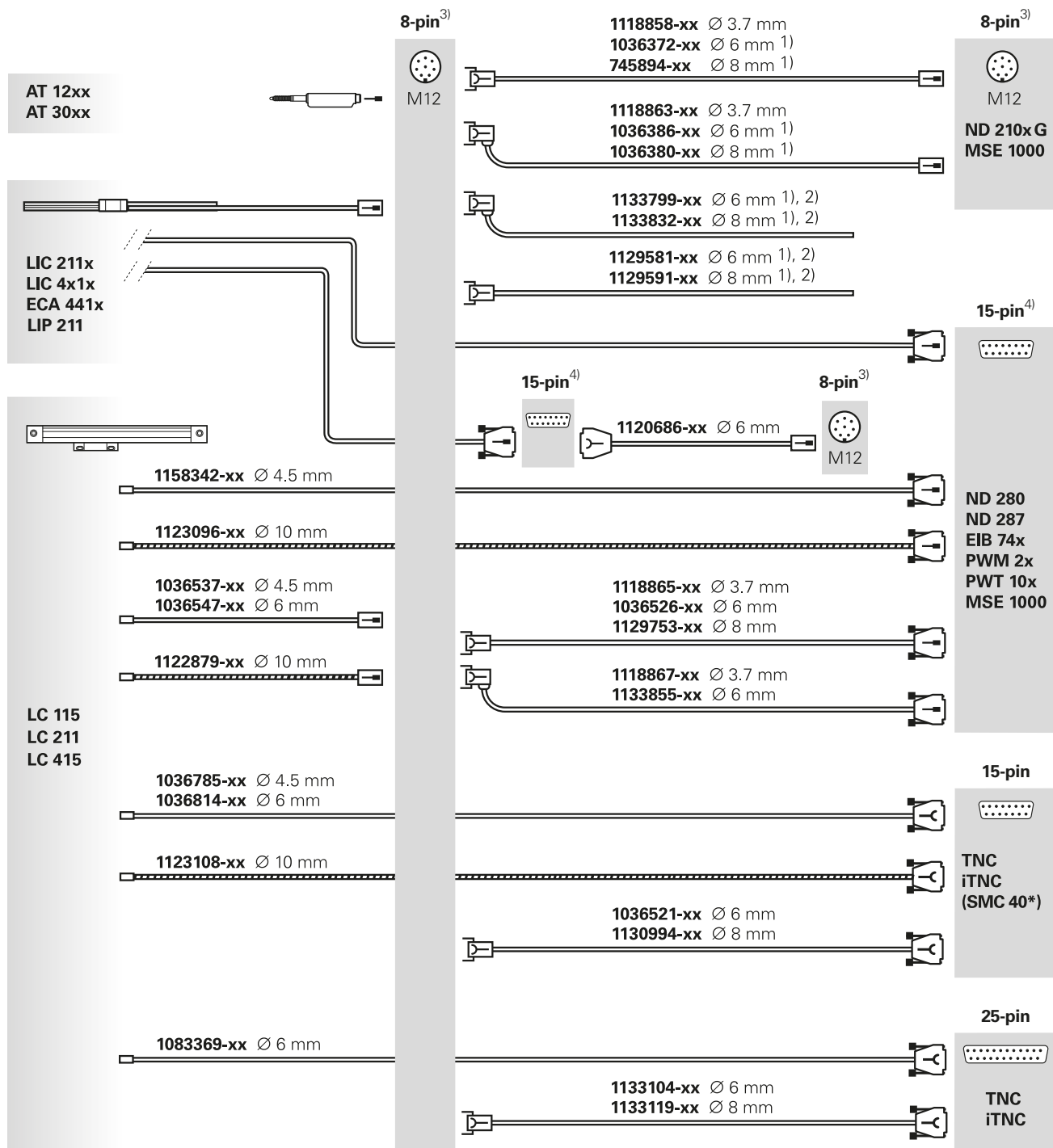

* Connection to SIEMENS NC
¹⁾ Also suitable for Fanuc/Mitsubishi/Panasonic/Yaskawa
²⁾ Note the connecting element for 8 MHz signal transmission
^{3), 4)} Identical pin layouts

Adapter cables and connecting cables – EnDat interface (EnDat22)

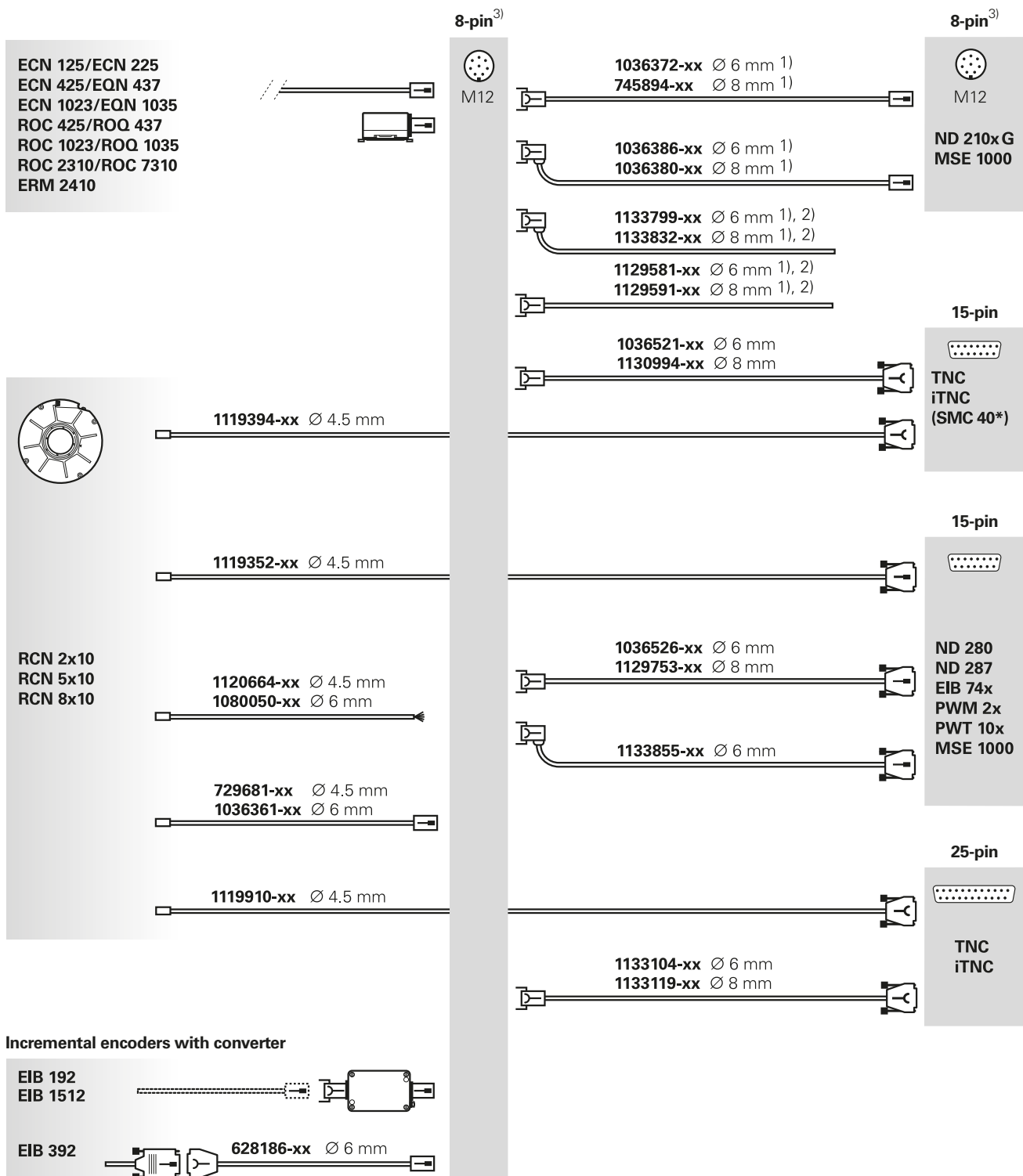

* Connection to SIEMENS NC

¹⁾ Also suitable for Fanuc/Mitsubishi/Panasonic/Yaskawa

²⁾ Note the connecting element for 8 MHz signal transmission

³⁾ Identical pin layouts

Adapter cables and connecting cables – EnDat interface (EnDat22)

Do not use for new applications!

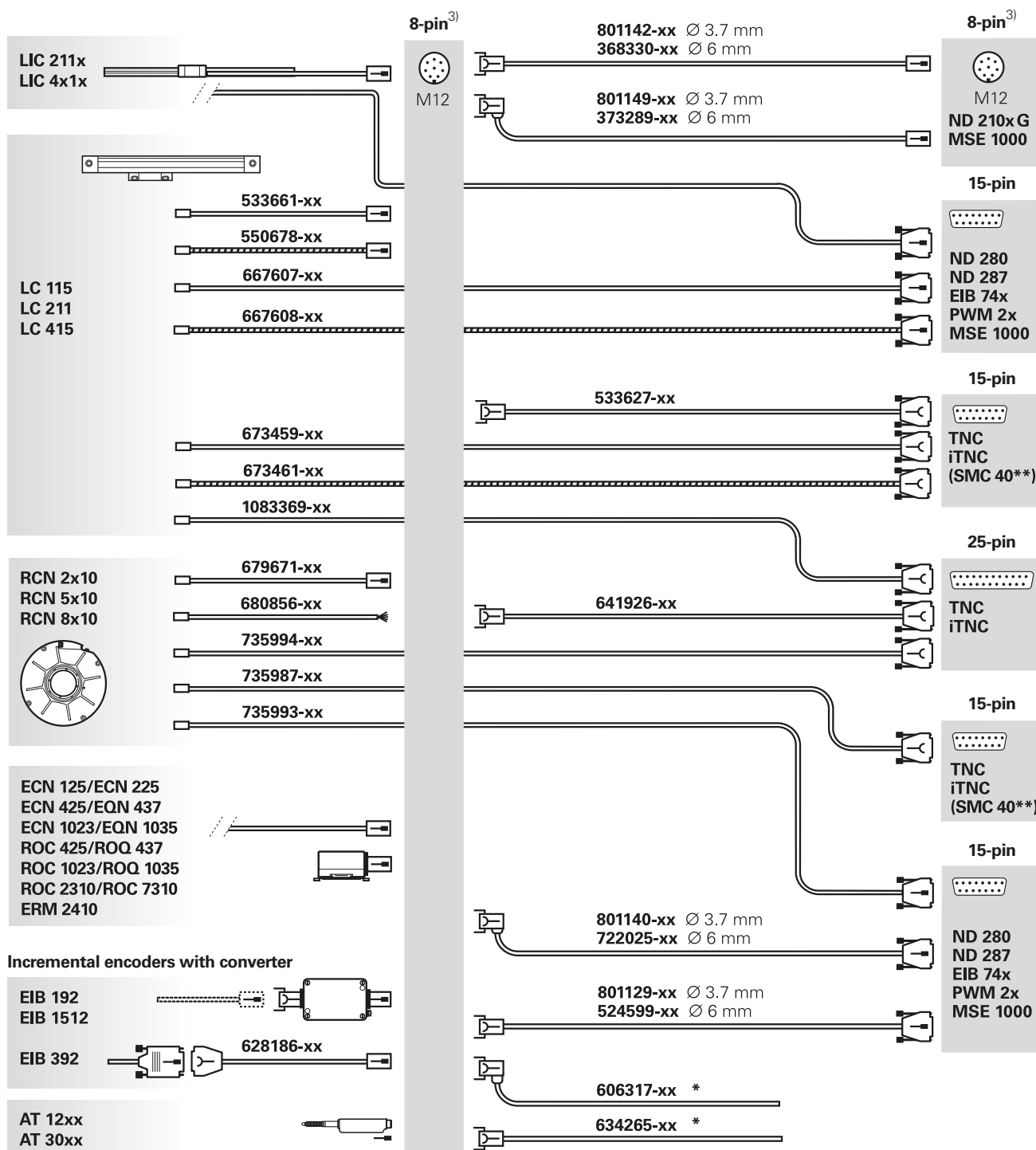

* Note the connecting element for 8 MHz signal transmission

** Connection to SIEMENS NC

³⁾ Identical pin layouts

Adapter cables and connecting cables – DRIVE-CLiQ

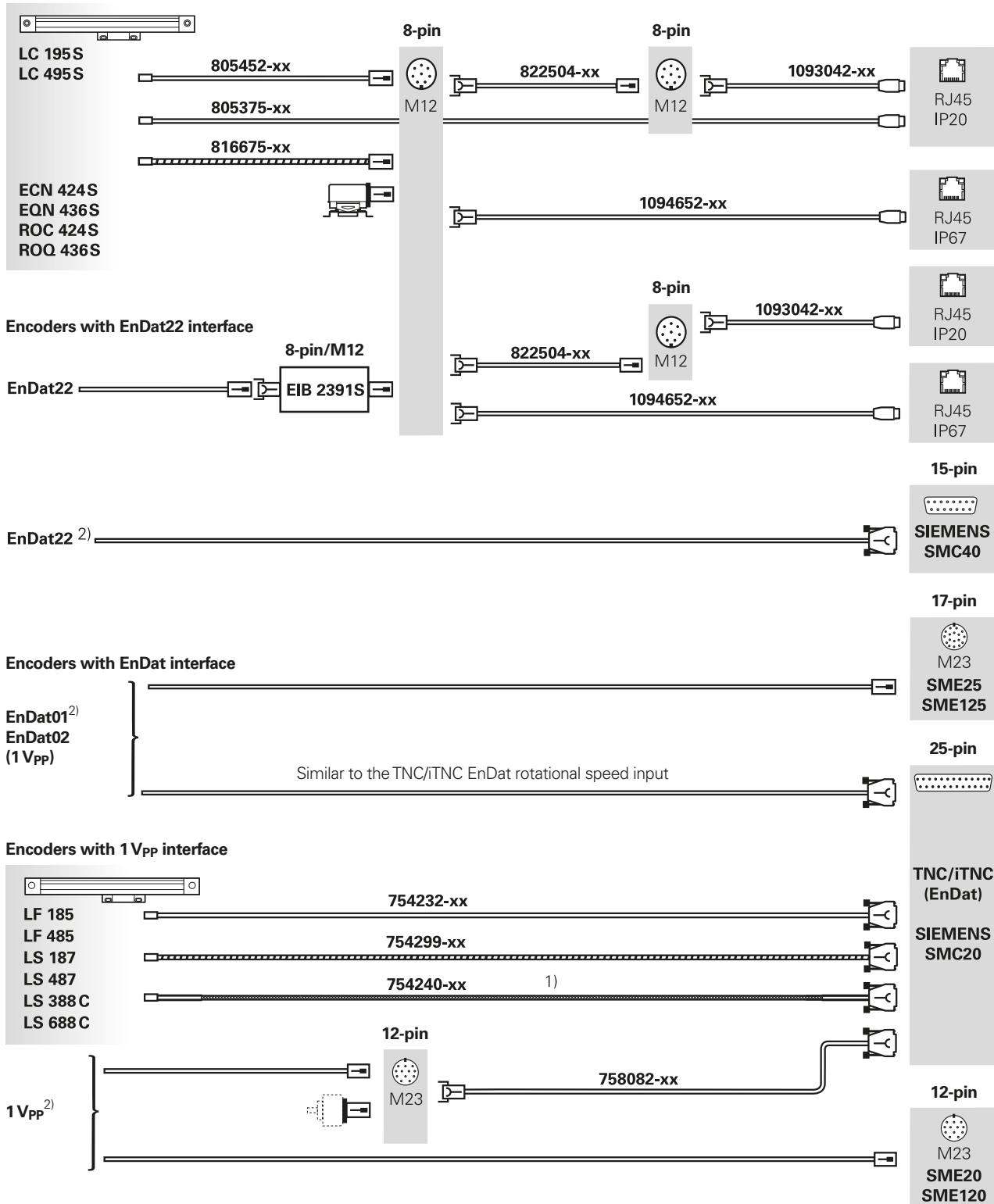

¹⁾ Cable with braided shield
²⁾ See applicable cable overviews
³⁾ Identical pin layouts

DRIVE-CLiQ is a registered trademark of SIEMENS AG.

Adapter cables and connecting cables – Fanuc Serial Interface

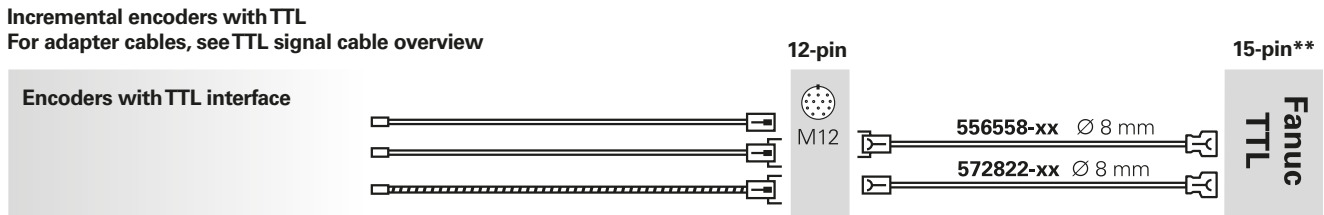
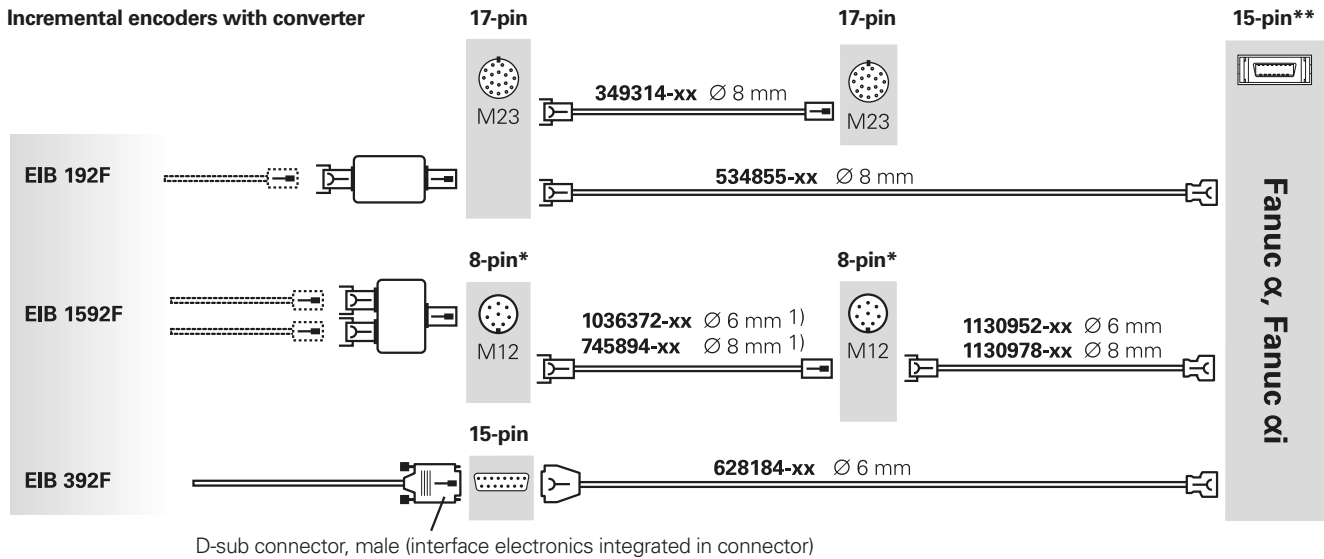

Caution: Always individually test the compatibility of the TTL interface between the encoder and Fanuc!

- 1) For more M12 connecting cables, see EnDat interface (EnDat22)
- * Recommended for new applications
- ** 20-pin connector housing with 15-pin insert

Adapter cables and connecting cables – Fanuc Serial Interface

Do not use for new applications!

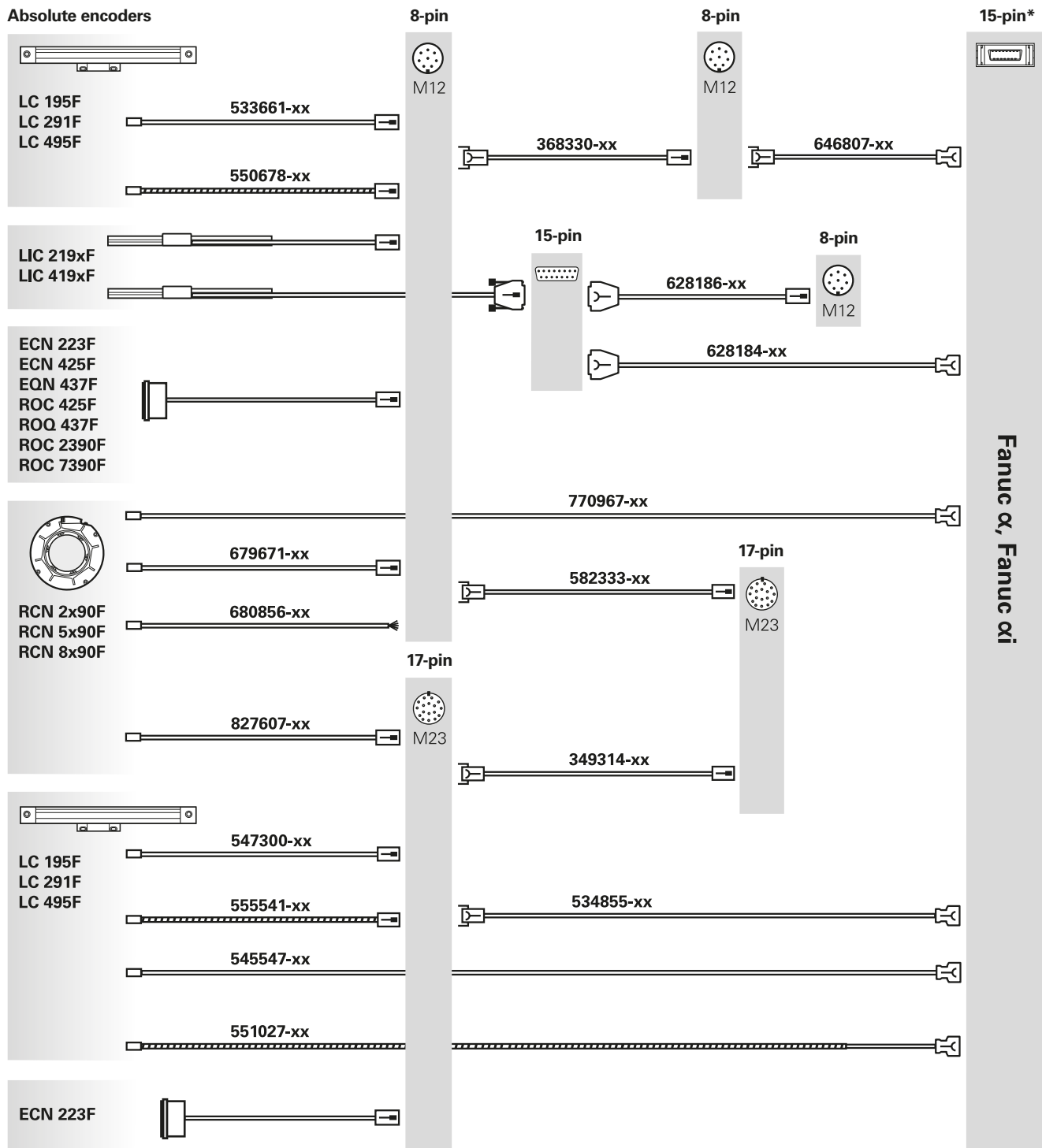

* 20-pin connector housing with 15-pin insert

Adapter cables and connecting cables – Fanuc Serial Interface

Do not use for new applications!

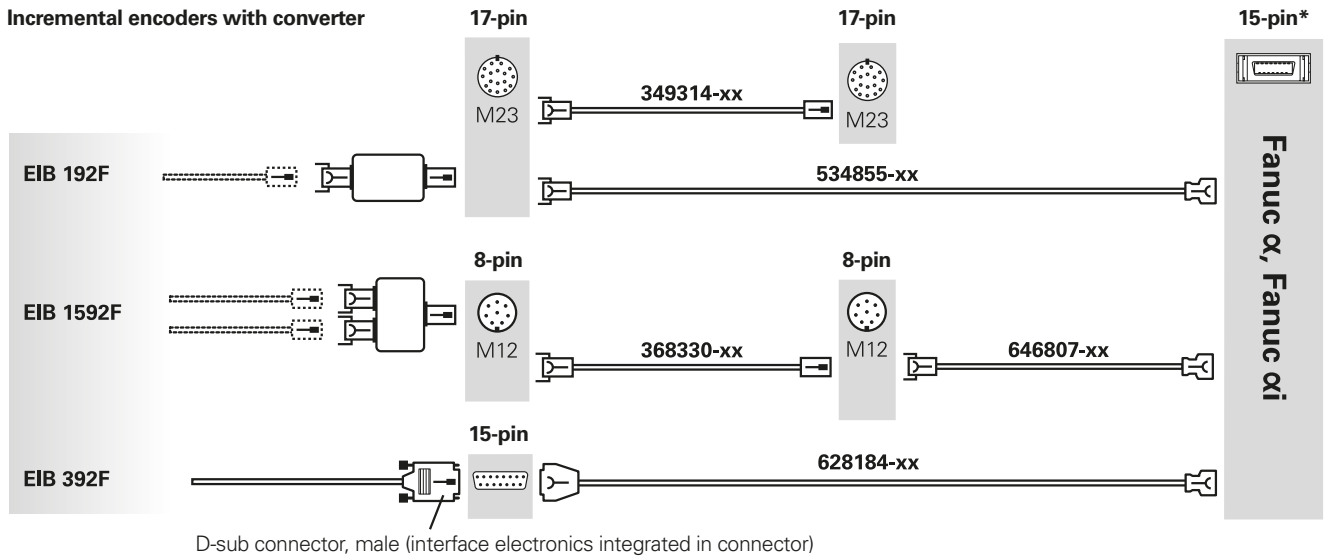

Incremental encoders with TTL
For adapter cables, see TTL signal cable overview

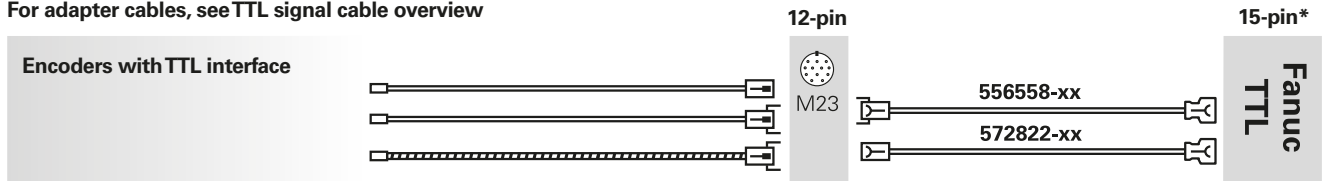

Caution: Always individually test the compatibility of the TTL interface between the encoder and Fanuc!

* 20-pin connector housing with 15-pin insert

Adapter cables and connecting cables – Mitsubishi high speed interface

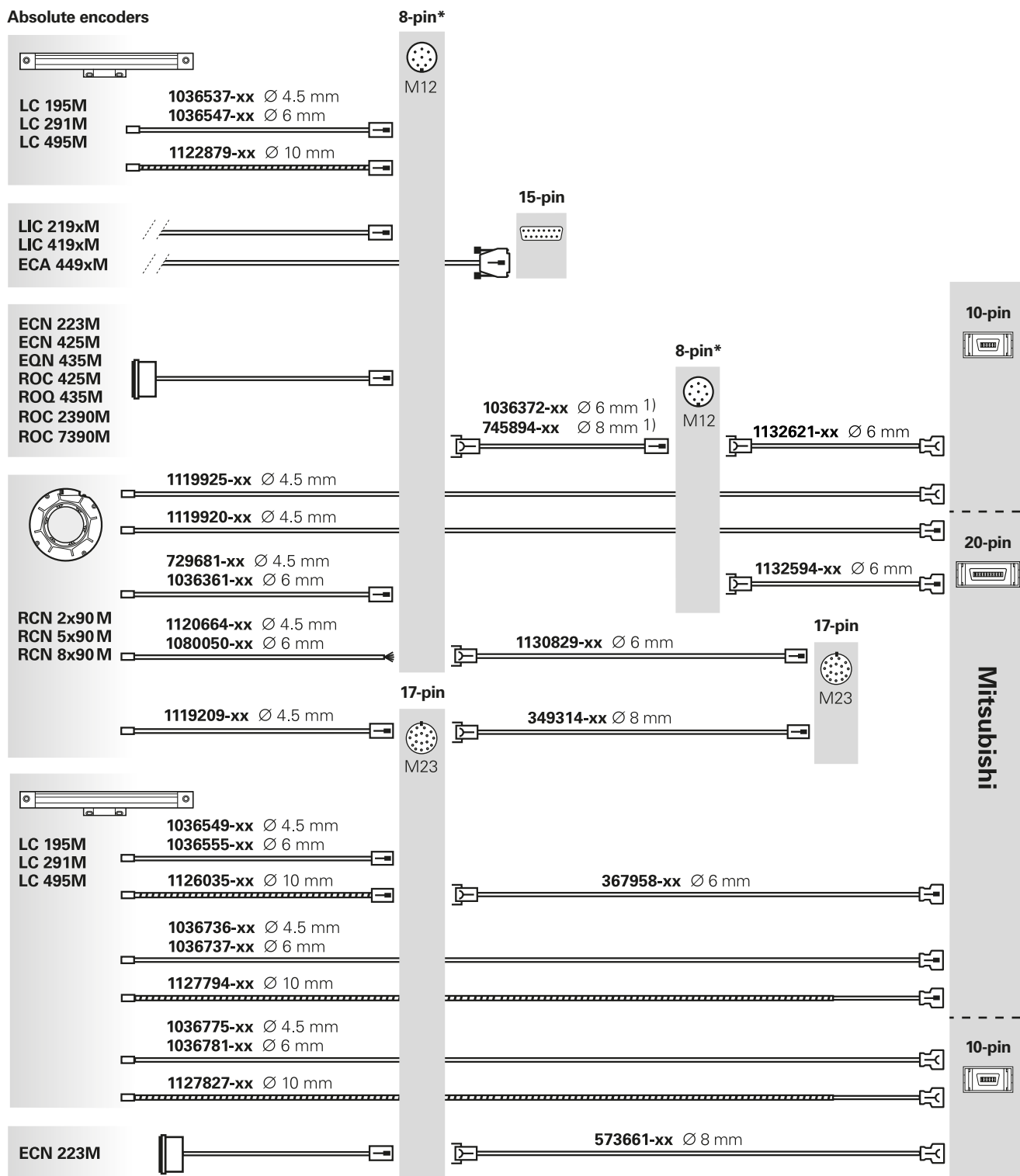

¹⁾ For more M12 connecting cables, see EnDat interface (EnDat22)

* Recommended for new applications

Adapter cables and connecting cables – Mitsubishi high speed interface

Incremental encoders with converter

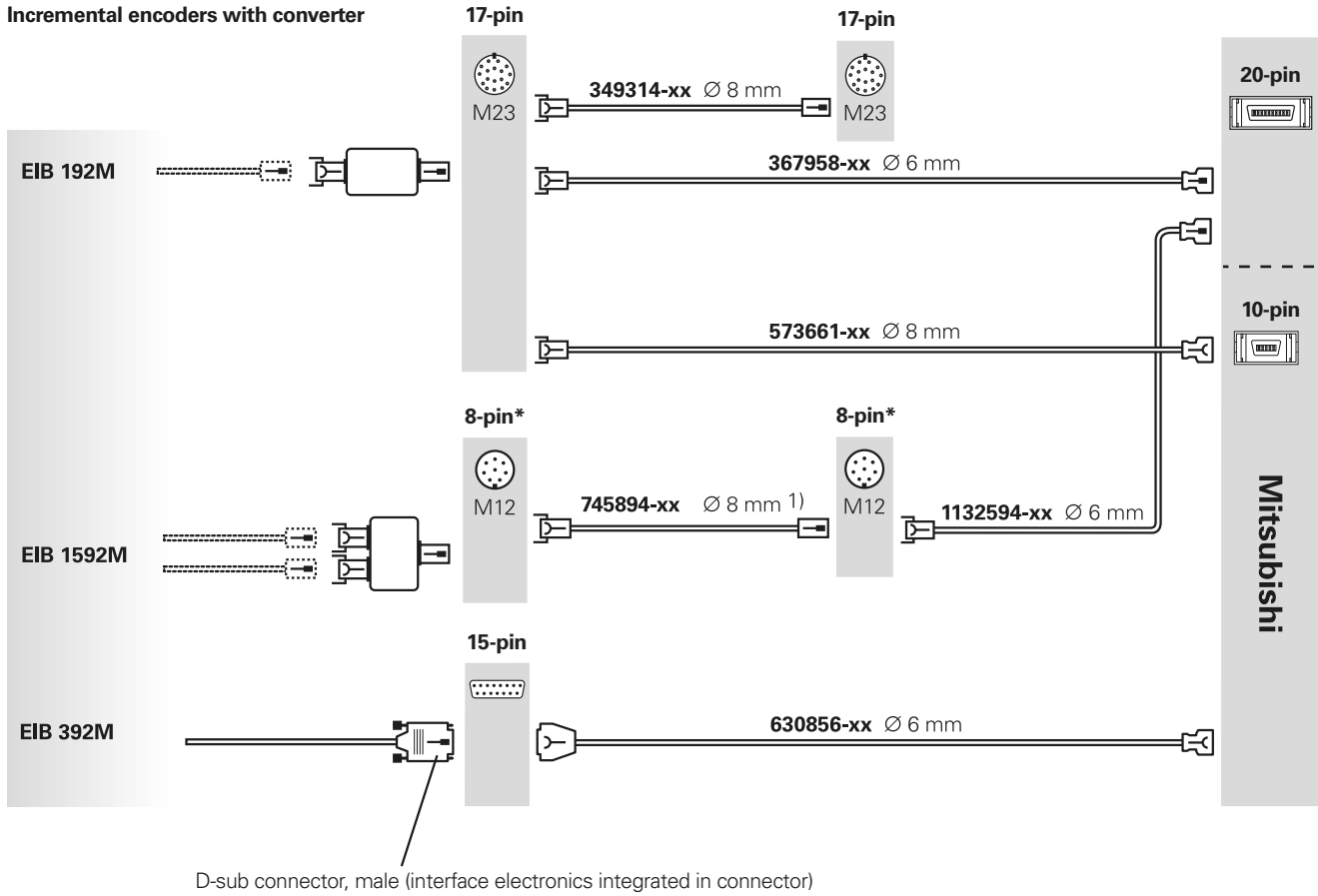

¹⁾ For more M12 connecting cables, see EnDat interface (EnDat22)

* Recommended for new applications

Adapter cables and connecting cables – Mitsubishi high speed interface

Do not use for new applications!

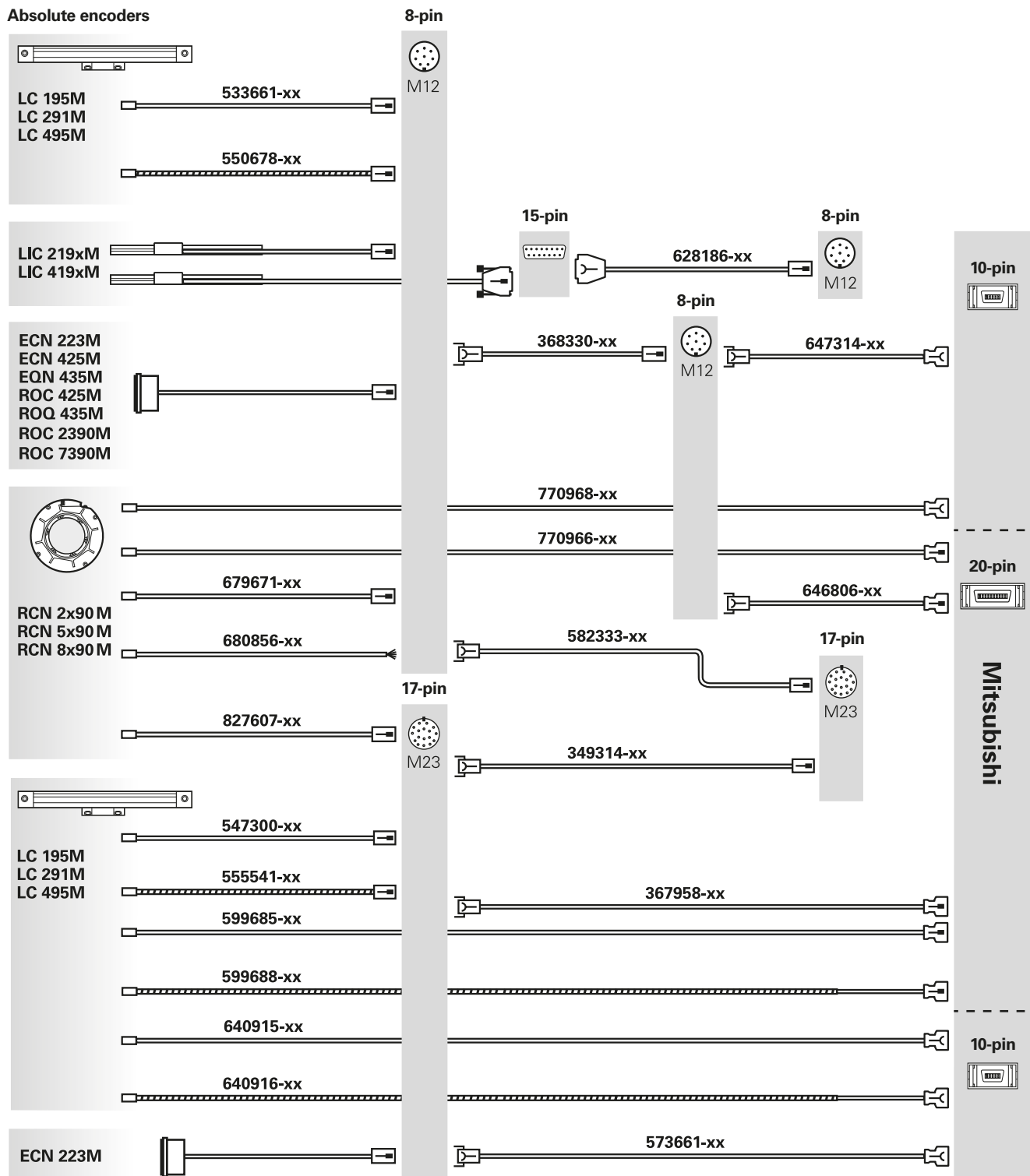

Adapter cables and connecting cables – Mitsubishi high speed interface

Do not use for new applications!

Incremental encoders with converter

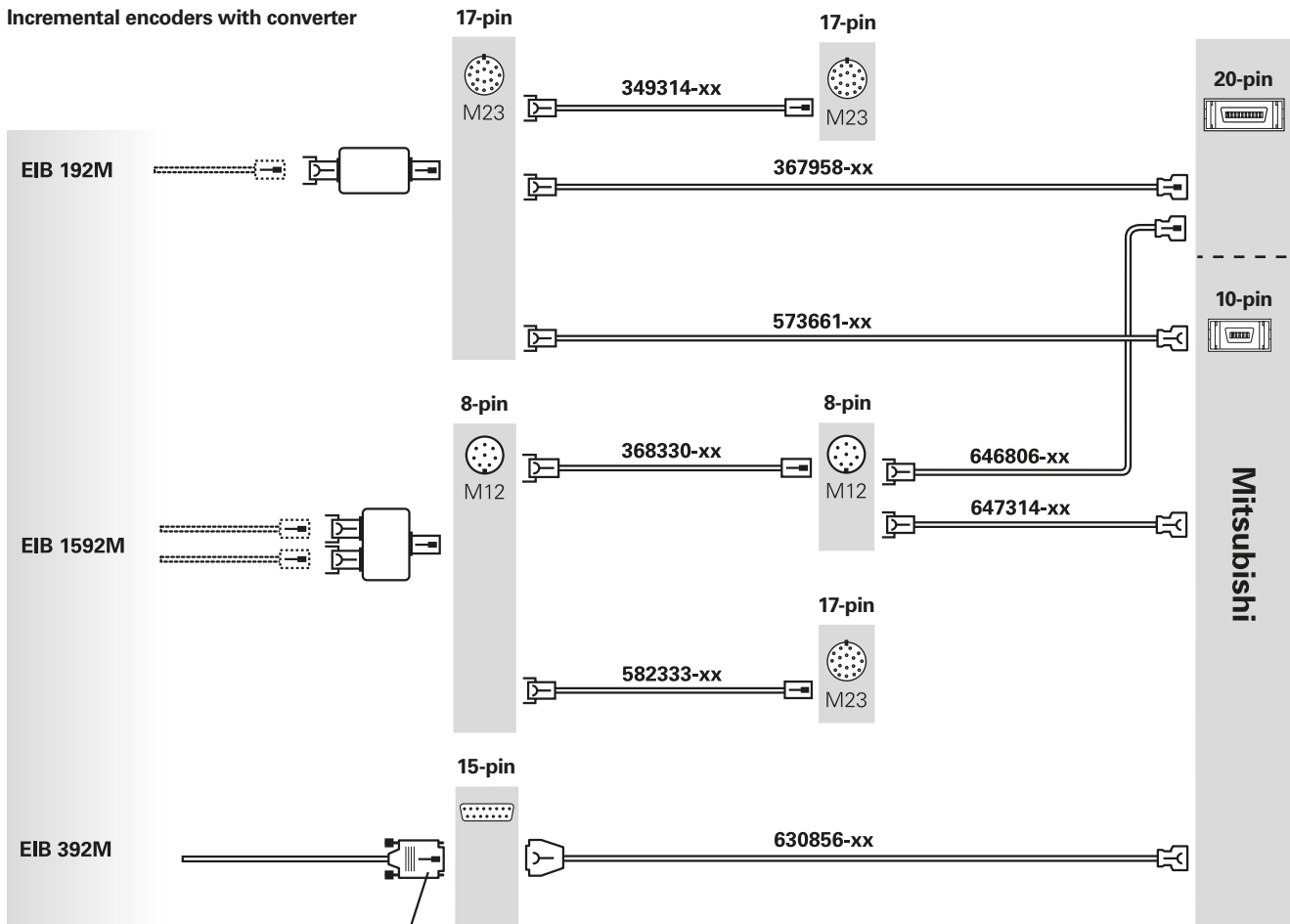

D-sub connector, male (interface electronics integrated in connector)

Adapter cables and connecting cables – Panasonic interface

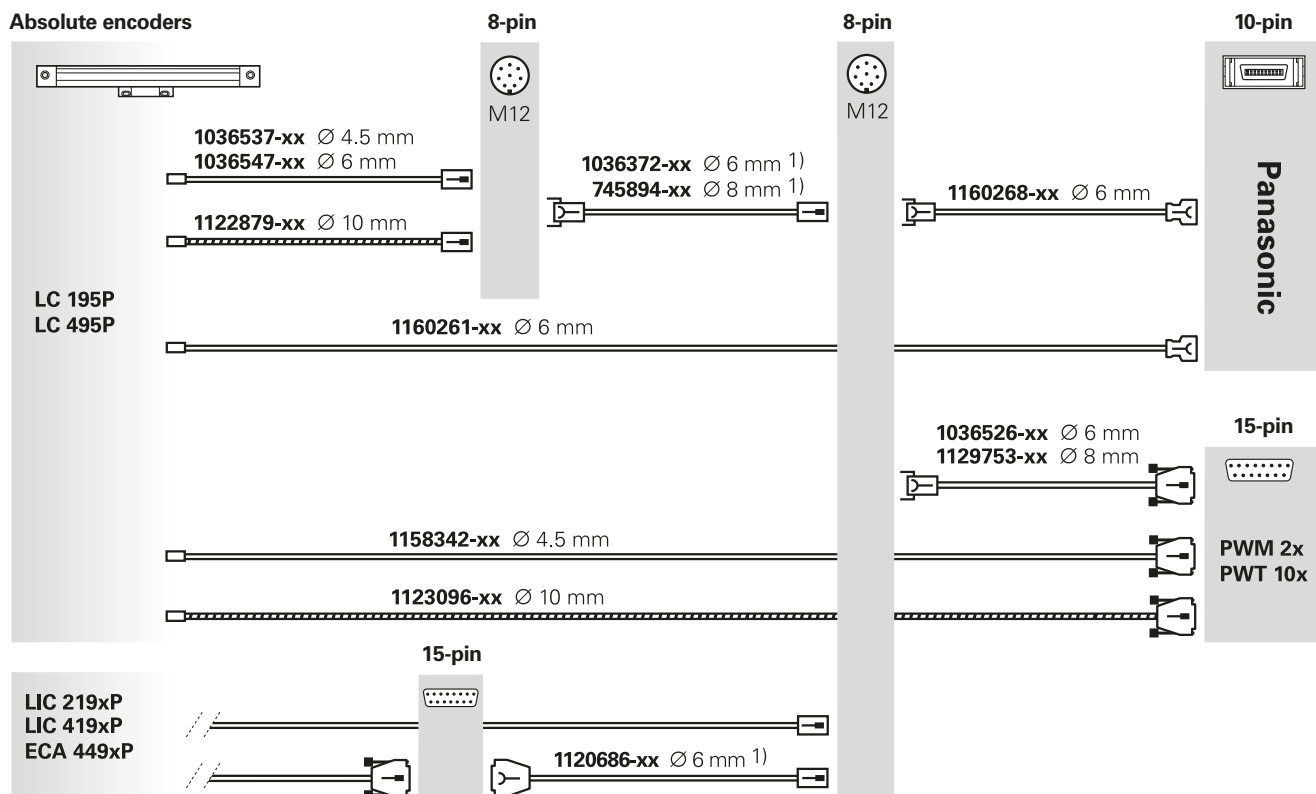

¹⁾ For more M12 connecting cables, see EnDat interface (EnDat22)

Change status 06/2017

Adapter cables and connecting cables – Yaskawa Serial Interface

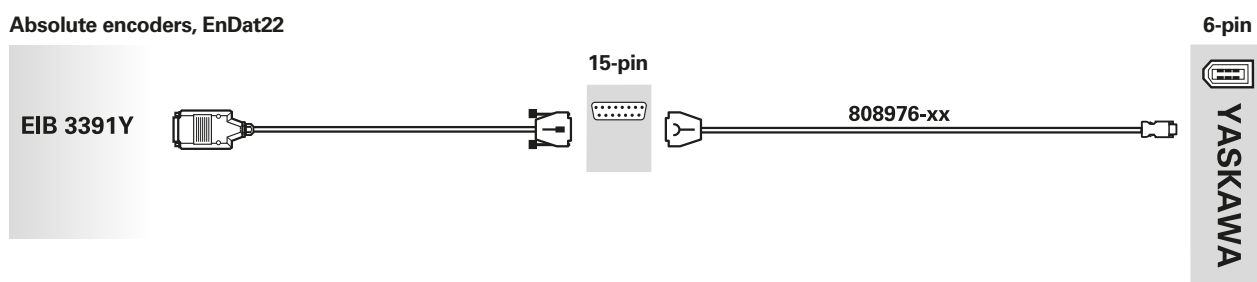

Change status 03/2016

Adapter cables and connecting cables – EnDat interface (EnDat0x) or SSI interface

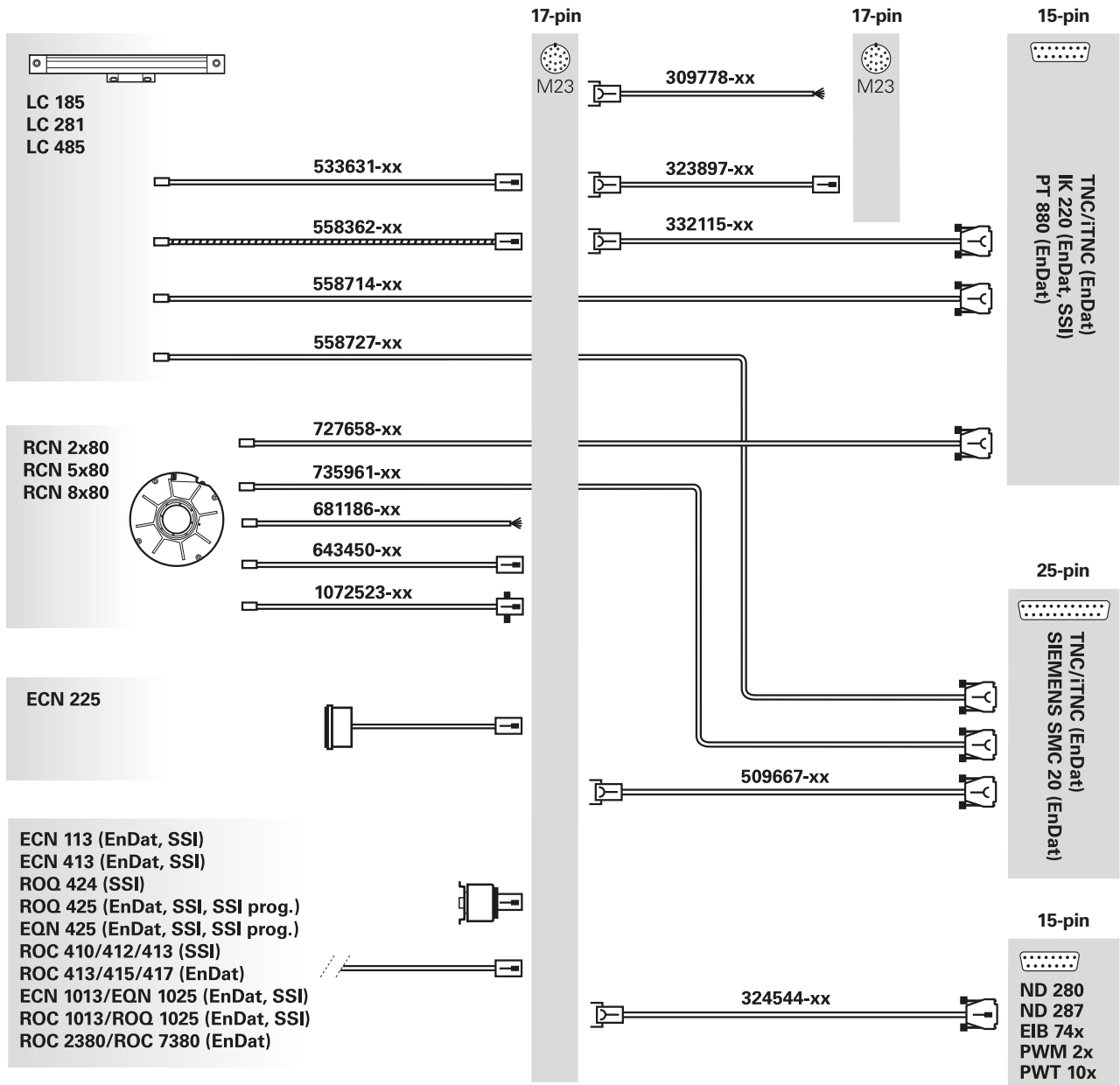

Adapter cables and connecting cables – 1 V_{PP} interface

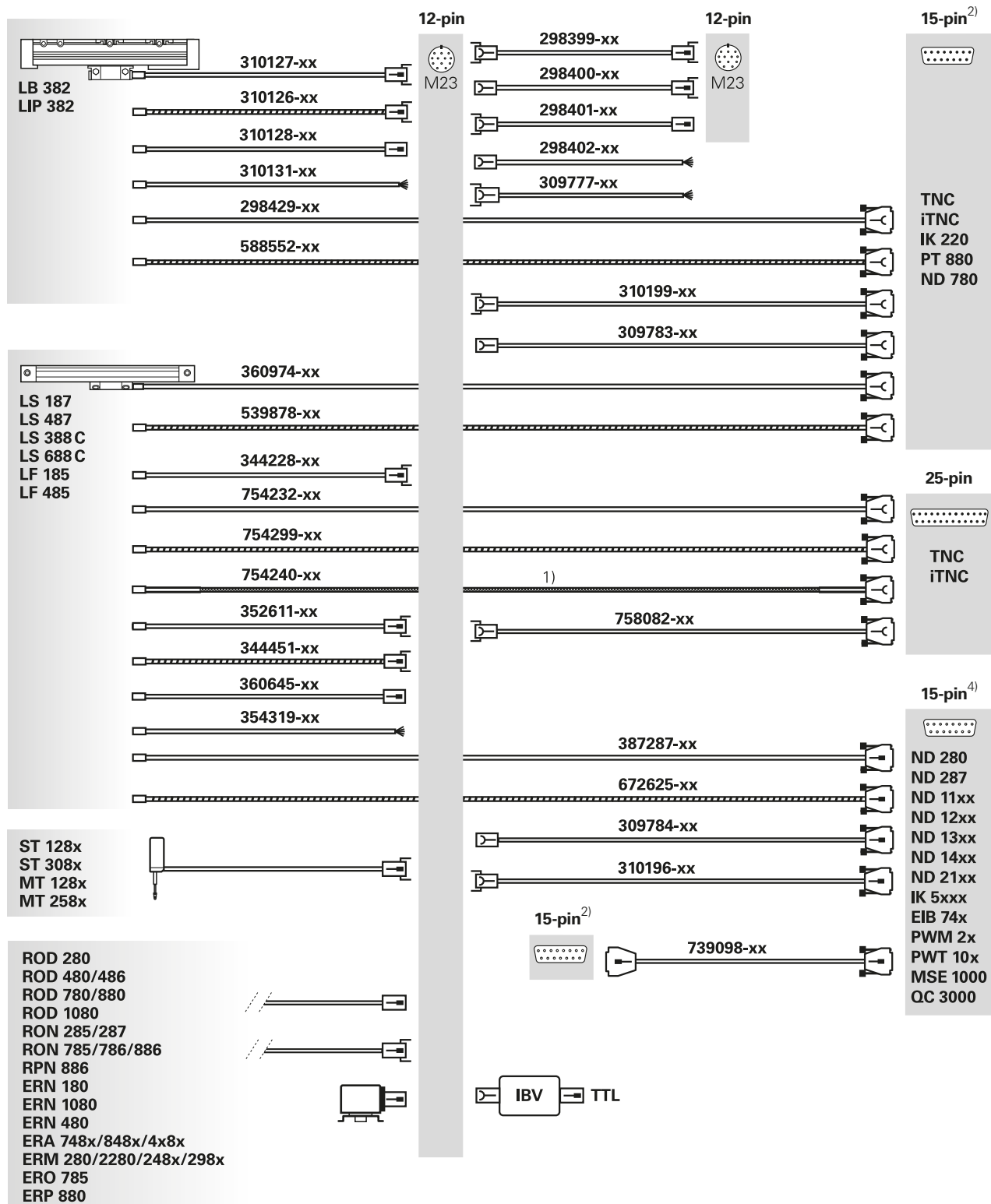

1) Cable with braided shield
2) Identical pin layouts

Adapter cables and connecting cables – 1 V_{PP} interface

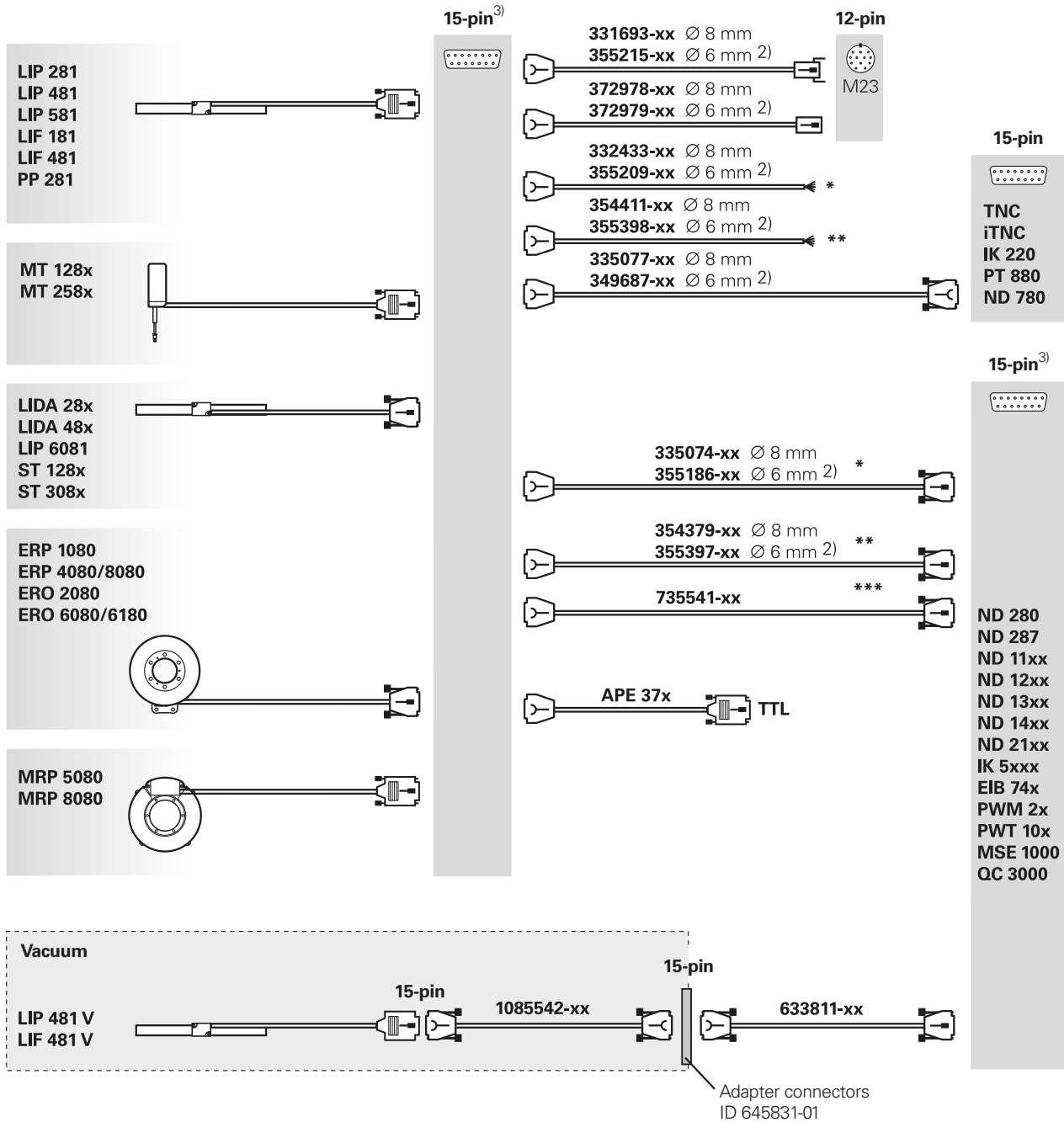

* Without limit or homing signals
 ** With limit and homing signals
 *** With programming line for mounting the LIP 281
 2) Max. cable length 9 m
 3) Identical pin layouts

Adapter cables and connecting cables – TTL or HTL interface

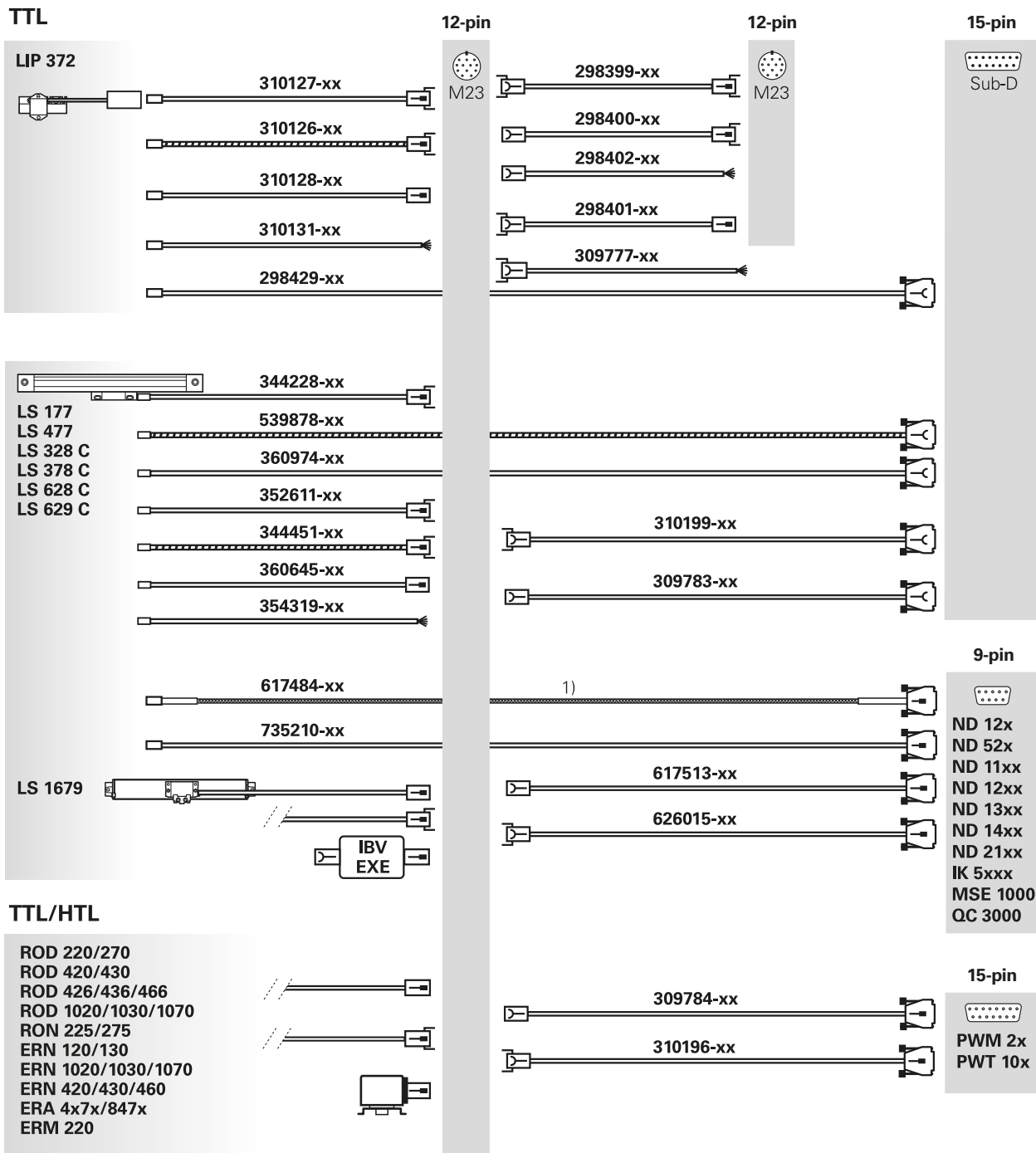

¹⁾ Cable with braided shield

Adapter cables and connecting cables – TTL or HTL interface

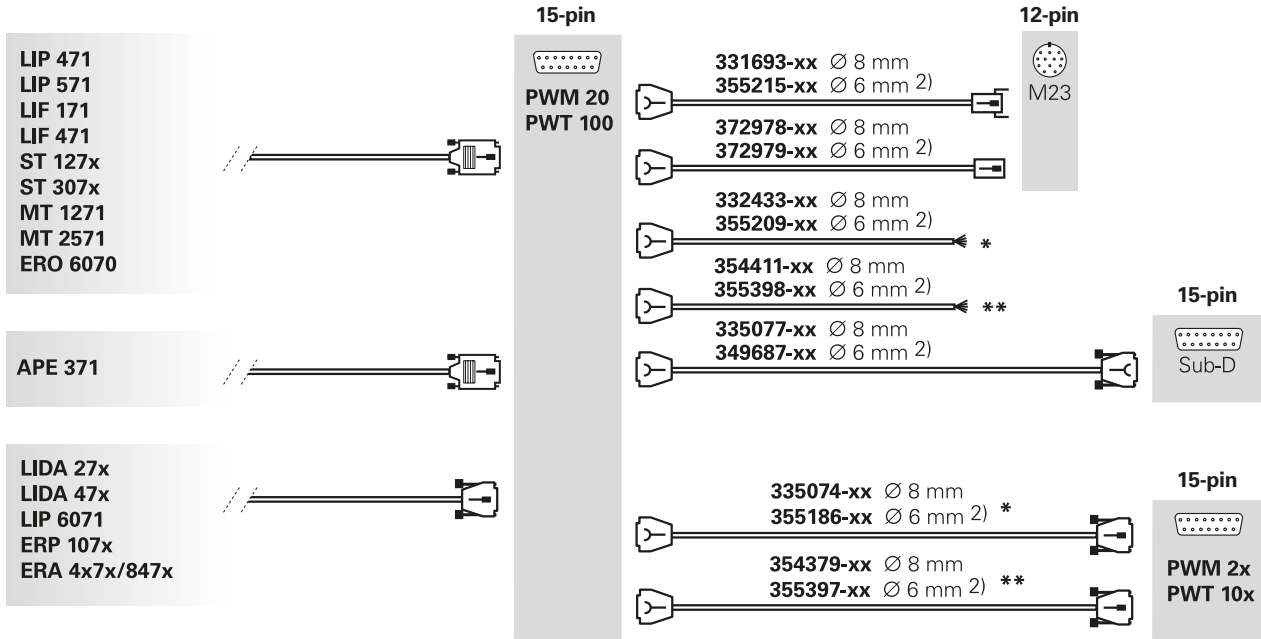

* Without limit or homing signals
 ** With limit and homing signals
 2) Max. cable length 9 m

Adapter cables and connecting cables – 11 μ APP interface

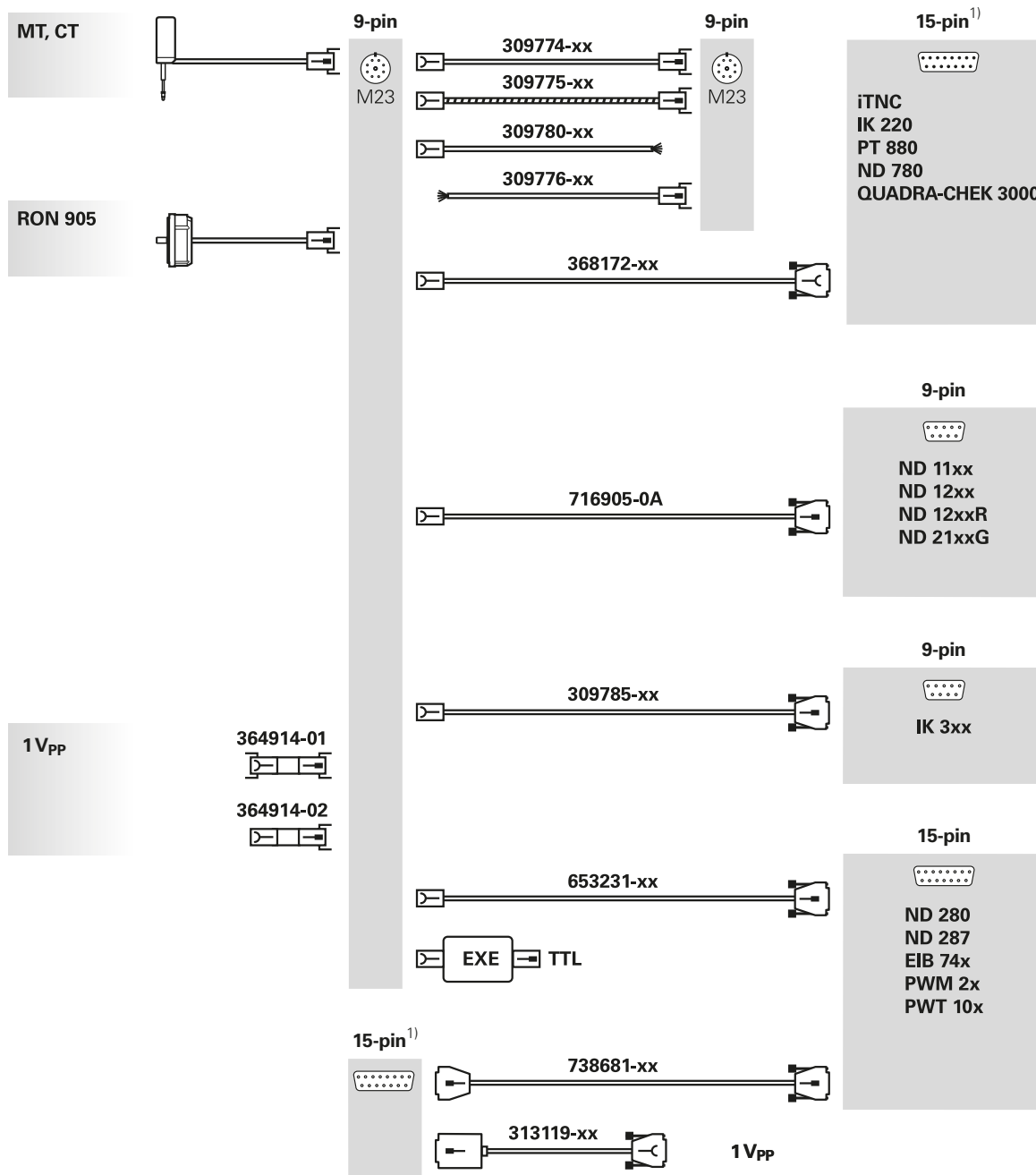

¹⁾ Identical pin layouts

Adapter cables and connecting cables – touch probes with EnDat or HTL interface

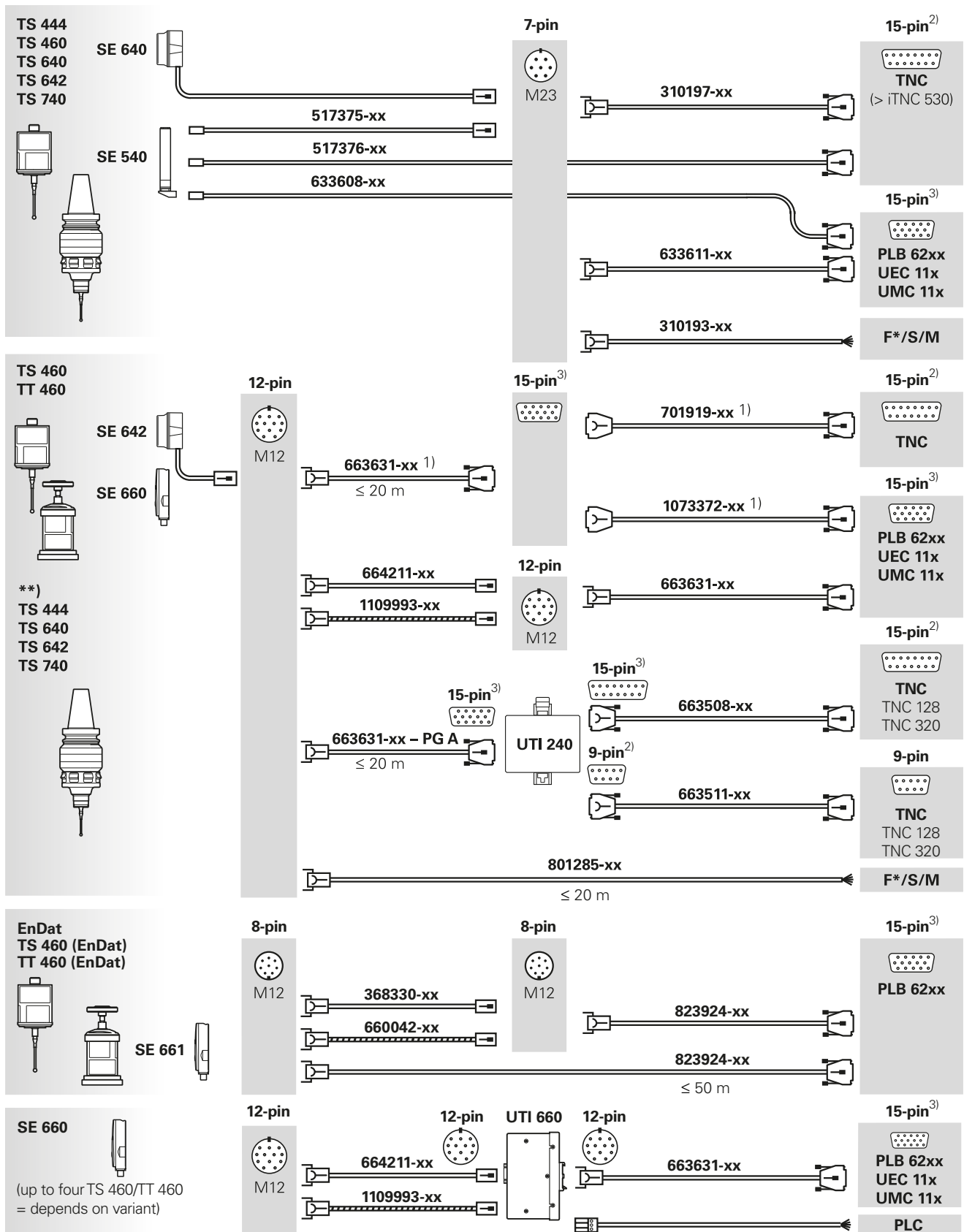

1) If total cable length is greater than 20 m, use ID 663631-xx for the first max. 10 m, and for the remaining length use ID 701919-xx/1073372-xx
 2), 3) Identical pin layouts

**) TS 444/64x/740 not possible in connection with SE 660
 F*/S/M = Fanuc/Siemens/Mitsubishi/Mazak, F* Fanuc High Speed Skip via UTI 491

Adapter cables and connecting cables – touch probes

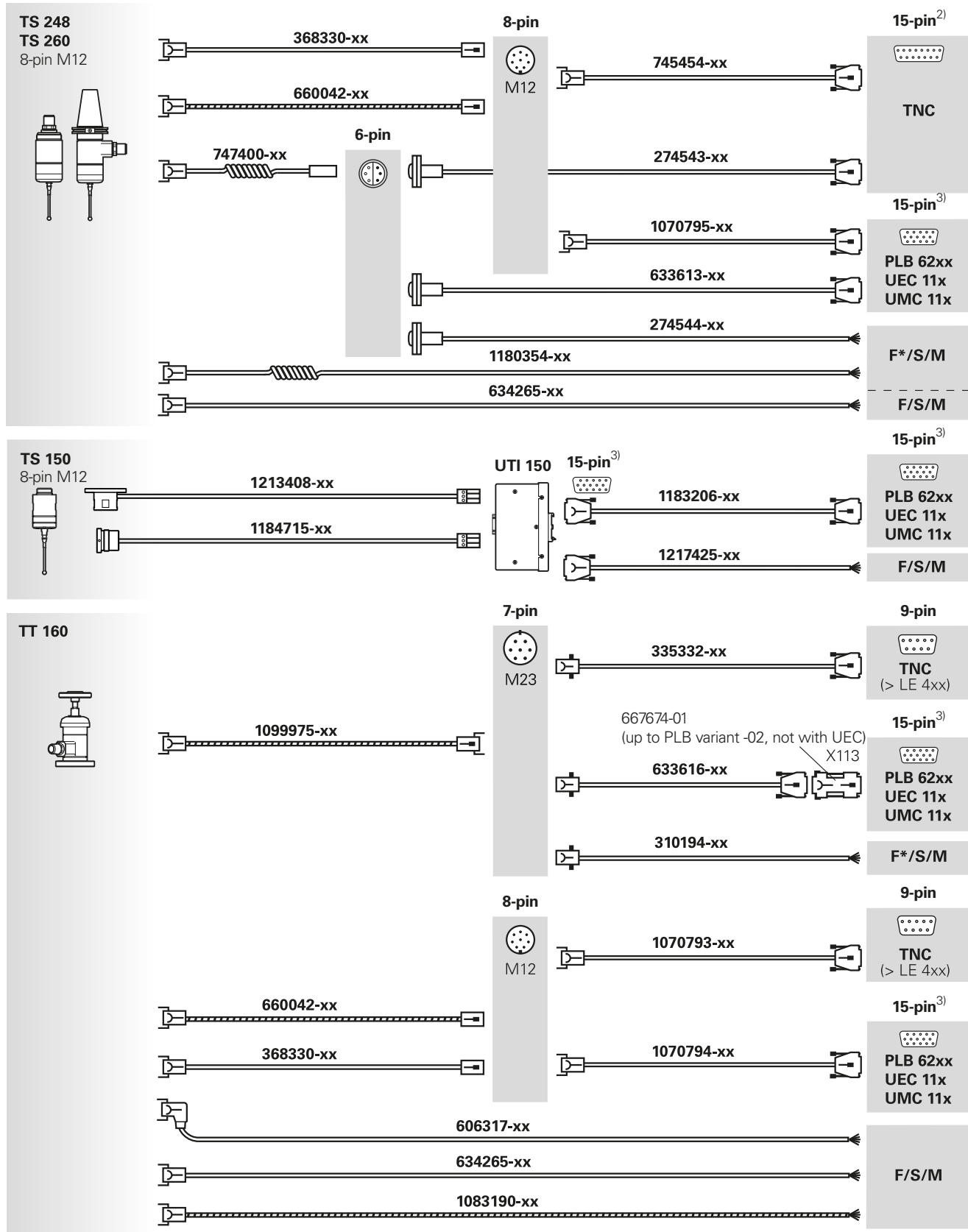

^{2), 3)} Identical pin layouts



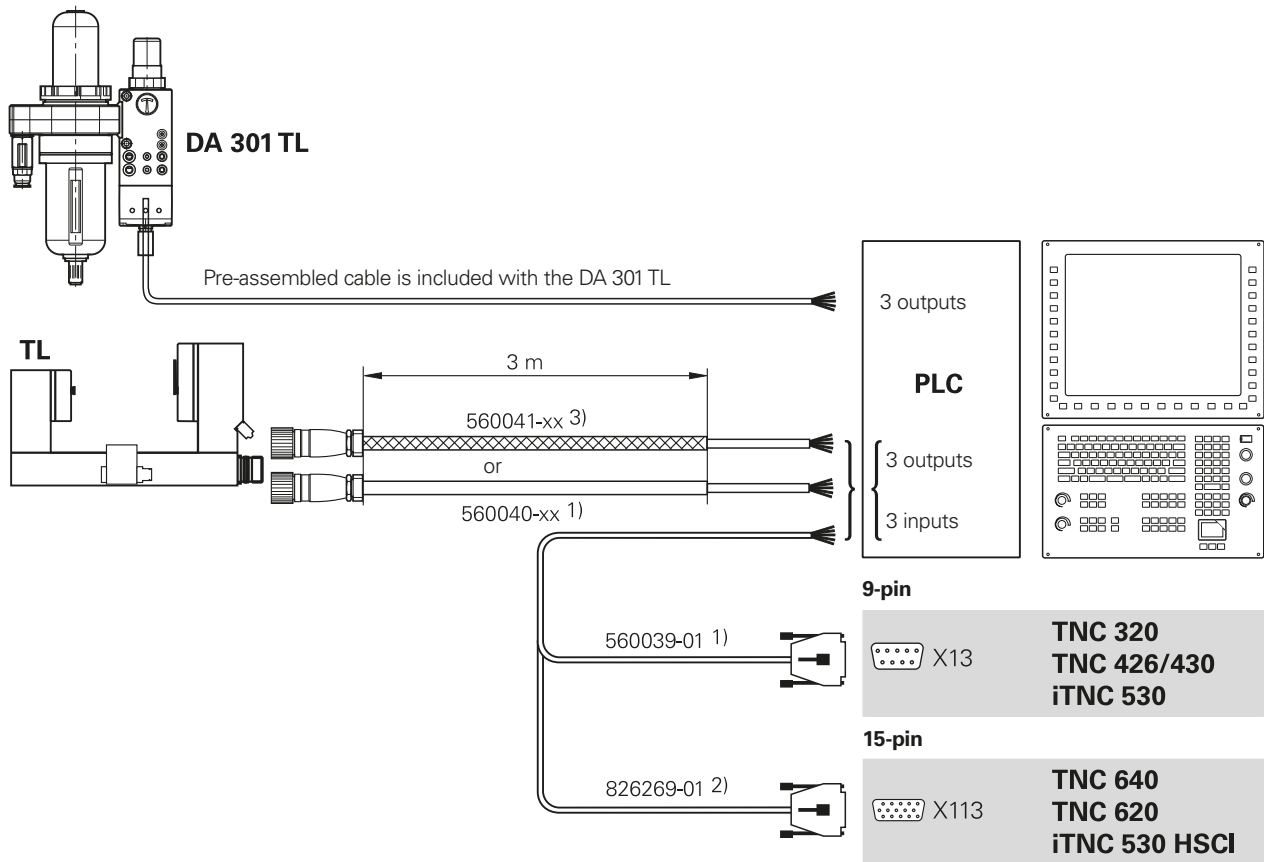

F/S/M = Fanuc/Siemens/Mitsubishi/Mazak, **F*** Fanuc High Speed Skip via UTI 491

Adapter cables and connecting cables – laser systems



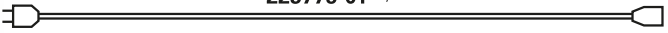
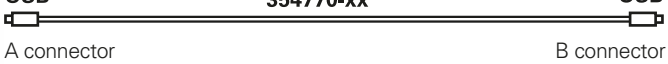
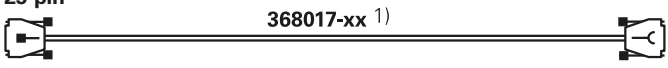

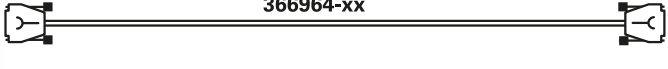
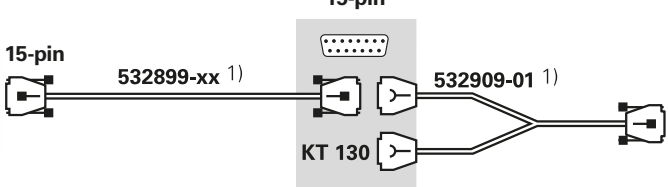

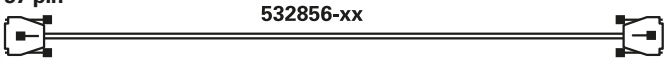
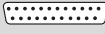





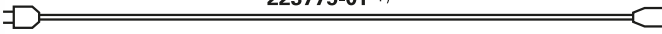







- 1) PUR cable
- 2) PVC cable
- 3) PUR cable with metal armor and steel-wire jacket

Adapter cables and connecting cables – digital readouts

Power cord	 <p>223775-01 ¹⁾</p>	ND 200 ND 522/523 ND 780 ND 1200R PT 880
PC	 <p>USB A connector 354770-xx USB B connector</p>	ND 280 ND 522/523 ND 1200R
V.24 cable to PC	 <p>25-pin 368017-xx ¹⁾ 9-pin</p>	 <p>ND 280 ND 780 ND 1200R PT 880</p>
V.24 cable to PC	 <p>9-pin 366964-xx 25-pin</p>	
IOB 49	 <p>15-pin 532899-xx ¹⁾ 15-pin 532909-01 ¹⁾ 15-pin KT 130</p>	 <p>ND 780</p>
IOB 89	 <p>37-pin 532856-xx 25-pin</p>	 <p>PT 880</p>

¹⁾ PVC cable

Adapter cables and connecting cables – evaluation electronics

Power cord	 223775-01 ¹⁾	Evaluation electronics units
PC	USB A connector  354770-xx  USB B connector	ND 122/123 ND 287
USB to printer	USB B connector  354770-xx  USB A connector	ND 1100 ND 1200 ND 1300 ND 1400 ND 2100G QUADRA-CHEK 3000
V.24 cable to PC	25-pin  368017-xx ¹⁾ 	9-pin  ND 287
V.24 cable to PC	9-pin  366964-xx 	
V.24 cable to PC	9-pin  540660-05 ¹⁾ 	9-pin  ND 1100 ND 1200 ND 1300 ND 1400 ND 2100G
RENISHAW touch trigger probe	5-pin  1095953-xx 	15-pin  ND 1100 ND 1400
	5-pin  1095709-xx 	15-pin  QUADRA-CHEK 3000

¹⁾ PVC cable

Output cable – EnDat interface (EnDat22)

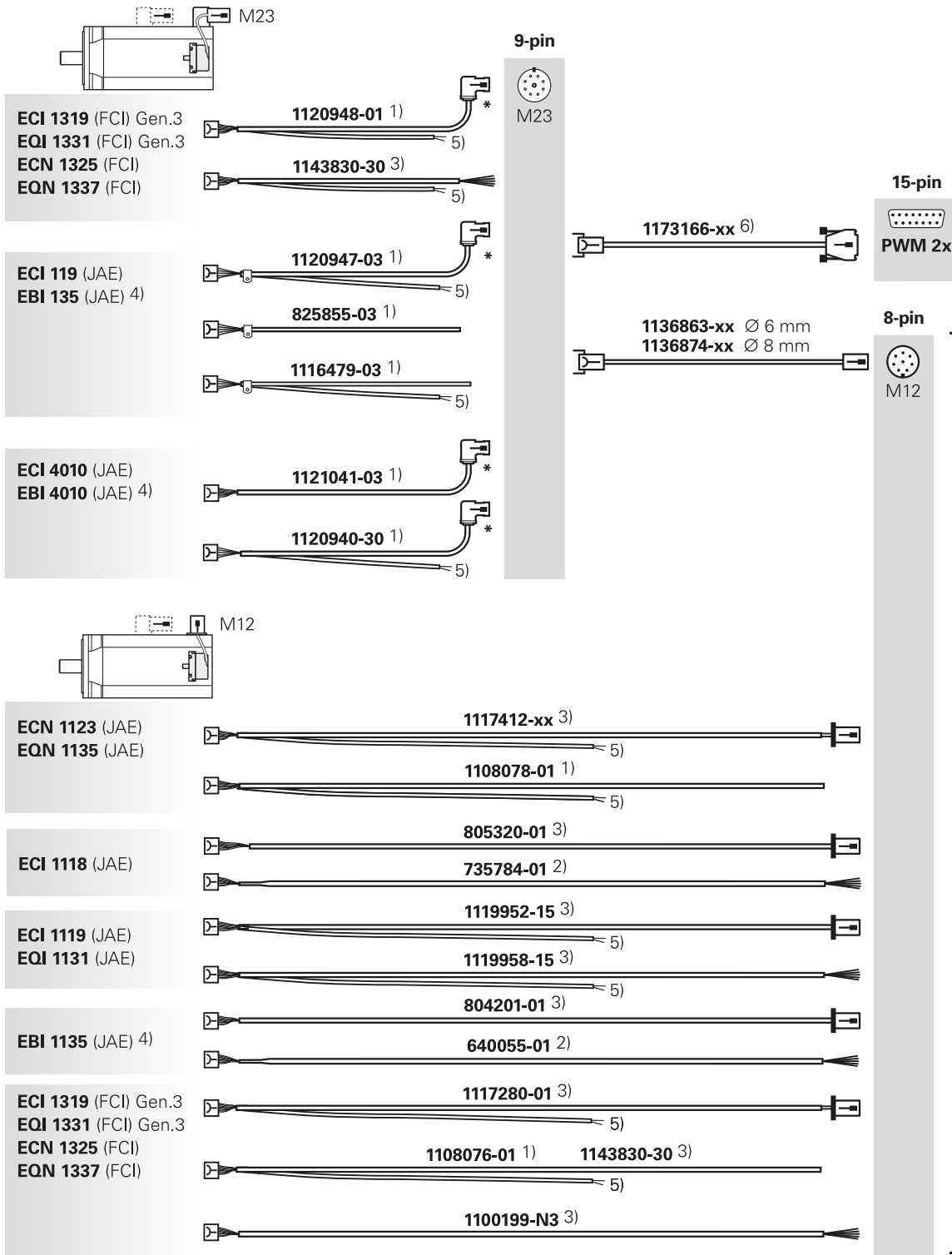

See EnDat interface (EnDat22) adapter cables and connecting cables

* SpeedTEC right-angle flange socket with O-ring for vibration protection, male (for Hypertac connector with O-ring; for SpeedTEC connector, remove O-ring)

1) EPG cable

2) Single wires with heat-shrink tubing (without shielding)

3) TPE single wires with net sleeves (without shield)

4) The TNC does not support battery-buffered multiturn functions; please note the pin layout

5) Wires for temperature sensors: 2 TPE wires in the heat shrink tubing

6) Not for EBI 135 and EBI 4010

SpeedTEC is a registered trademark of TE Connectivity Industrial GmbH.

Output cable – EnDat interface (EnDat22)

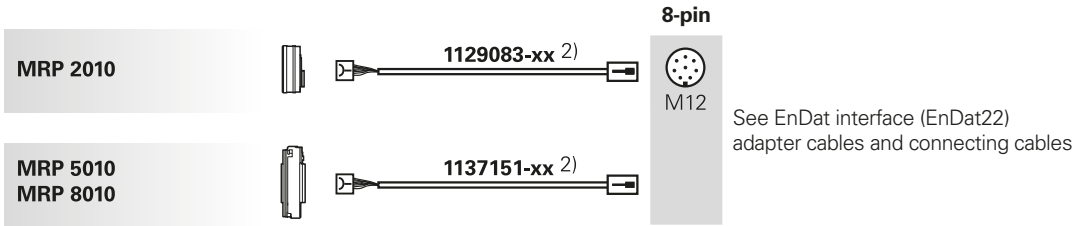

HMC 6 output cable and power cable with encoder communication

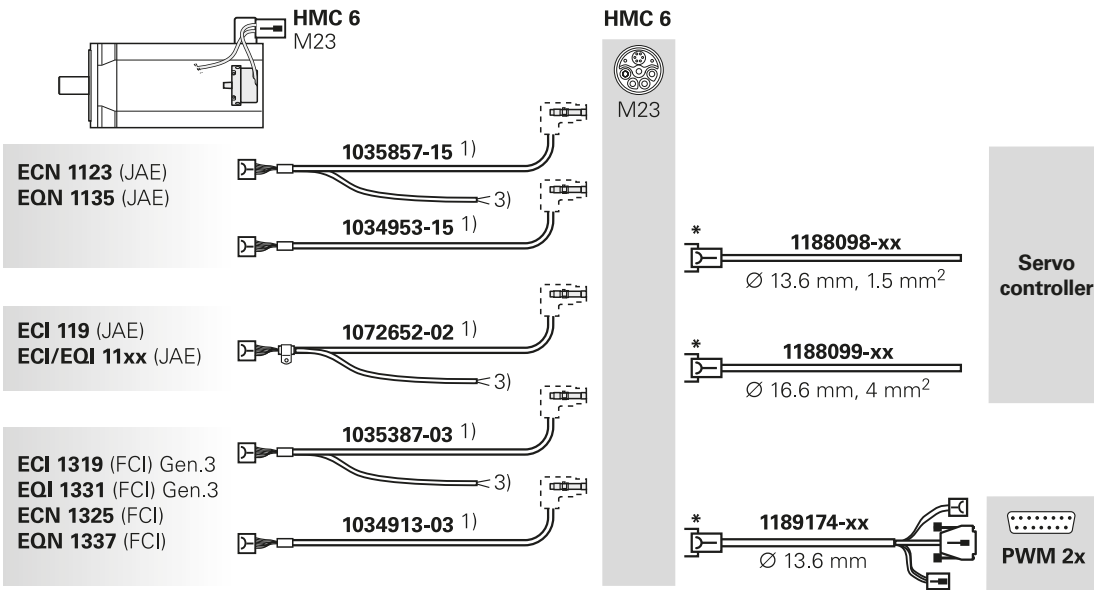

Communication element for SpeedTEC hybrid flange socket
SpeedTEC hybrid flange socket is not included in delivery
For more information, see the *Connecting elements* section and the Product Information document *HMC 6*

Test cable to PWM 2x

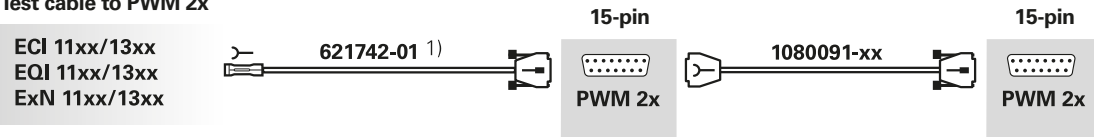

- * SpeedTEC hybrid connector, female
- ¹⁾ EPG cable
- ²⁾ Cable clamp included
- ³⁾ Wires for temperature sensors: 2 TPE wires in the heat shrink tubing

SpeedTEC is a registered trademark of TE Connectivity Industrial GmbH.

Output cable – DRIVE-CLiQ

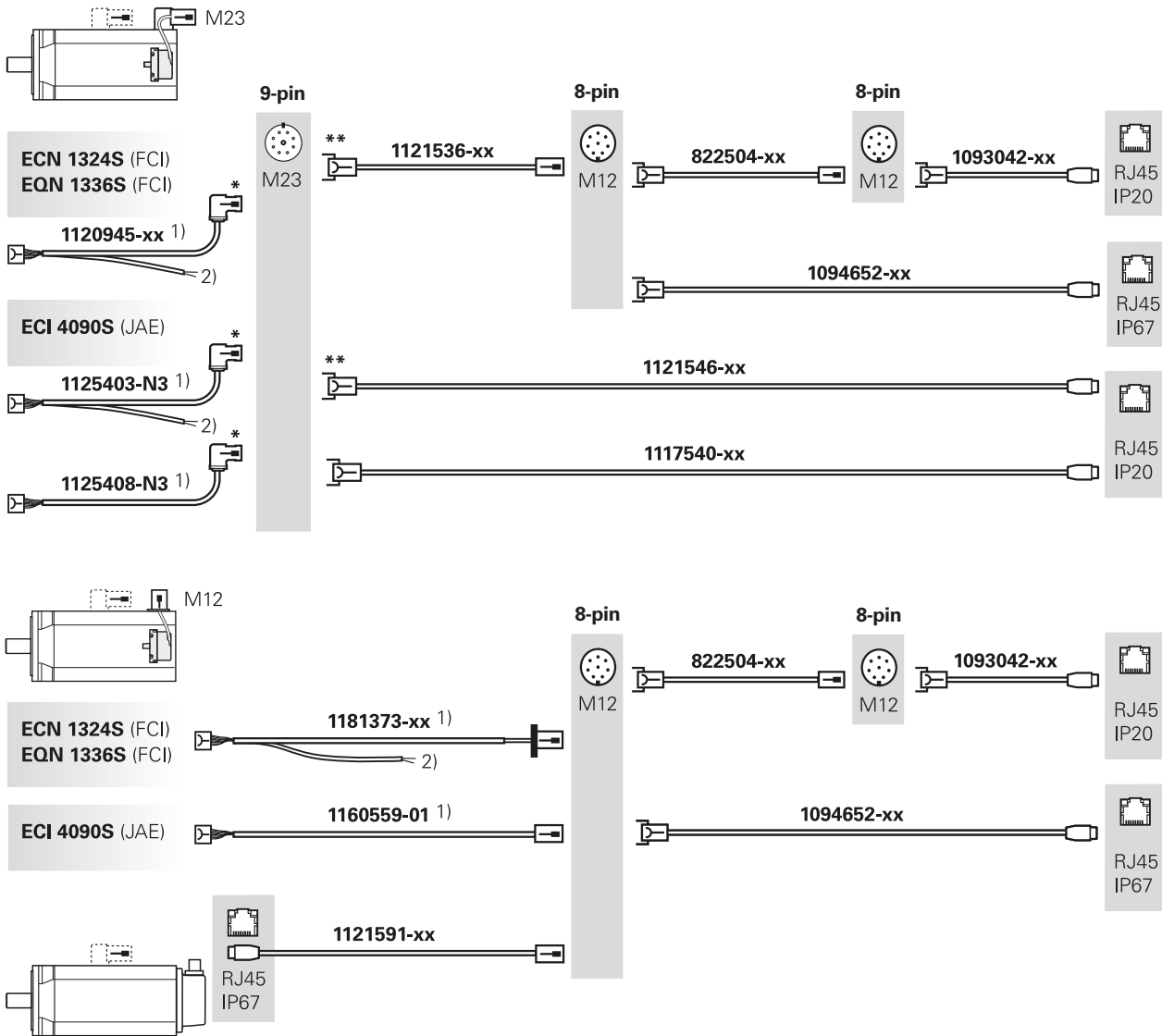

* SpeedTEC right-angle flange socket with O-ring for vibration protection, male (for Hypertac connector with O-ring; for SpeedTEC connector, remove O-ring)

** SpeedTEC connector, female

1) EPG cable

2) Wires for temperature sensors: 2 TPE wires in the heat shrink tubing

DRIVE-CLiQ is a registered trademark of SIEMENS AG.

SpeedTEC is a registered trademark of TE Connectivity Industrial GmbH.

Output cable – EnDat interface (EnDat01)

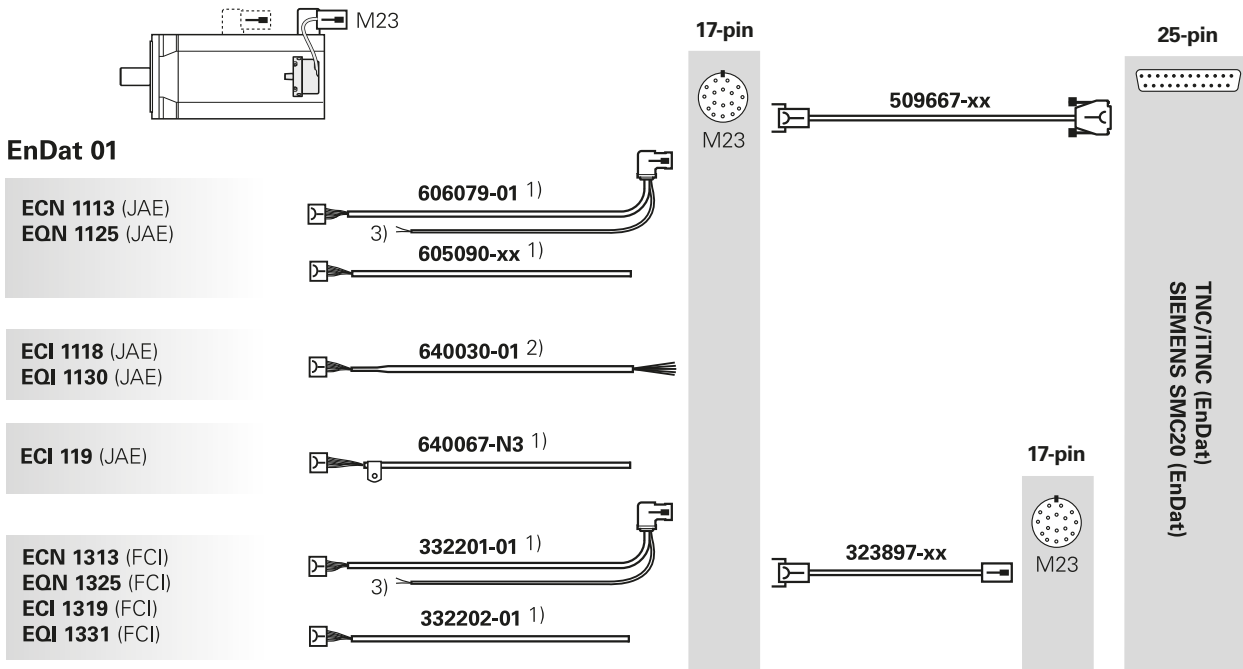

Motors from HEIDENHAIN for connection to TNCs have a different connector layout and must not be connected with the cables listed here.

For suitable cables, refer to the *cable overviews* in the TNC brochure *Information for the Machine Tool Builder*.

Test cable to PWM 2x

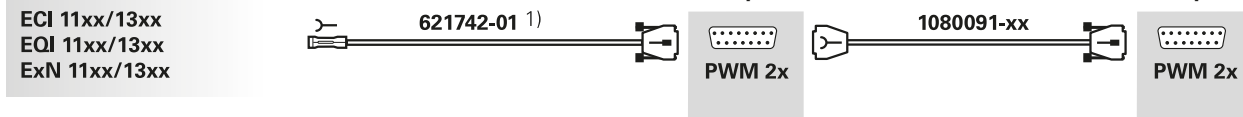

- 1) EPG cable
- 2) Single wires with heat-shrink tubing (without shielding)
- 3) Wires for temperature sensors: 2 polyolefin wires in the heat shrink tubing

Output cable – 1 V_{PP} or TTL interface

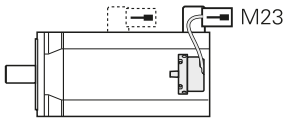

17-pin



ERN 1123 (JAE)

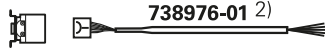

738976-01 ²⁾

ERN 1321 (FCI)
ERN 1381 (FCI)

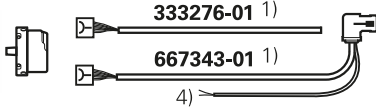

333276-01 ¹⁾

667343-01 ¹⁾

4)

ERN 1326 (FCI)

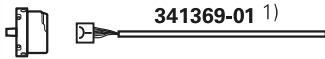

341369-01 ¹⁾

ERN 1387 (FCI)

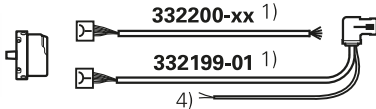

332200-xx ¹⁾

332199-01 ¹⁾

4)

ERO 14x0 (FCI)

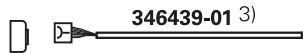

346439-01 ³⁾

ERO 12x5 (Hirose)
ERP 880 (Hirose)

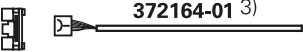

372164-01 ³⁾

MRP 2080

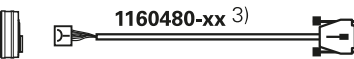

1160480-xx ³⁾

15-pin



See "Adapter cables and connecting cables 1 V_{PP} interface"

Test cable to PWM 2x

ERN 1387

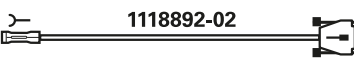

1118892-02

15-pin



PWM 2x

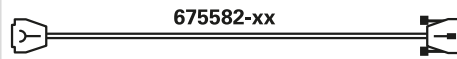

675582-xx

15-pin



PWM 2x

- 1) EPG cable
- 2) Single wires with heat-shrink tubing (without shielding)
- 3) Cable clamp included
- 4) Wires for temperature sensors: 2 polyolefin wires in the heat shrink tubing

Cable list

Information on cable list

The cable list contains all available HEIDENHAIN cables. The cables are sorted in ascending order according to part numbers (ID). The most important selection criteria are listed for each cable.

Cable diameter

An important criterion for the minimum bending radius of the cable, besides the material of the cable jacket, is the cable diameter (see *General Information*).

Length

HEIDENHAIN cables are available in gradations of length. Special lengths are available upon request.

You will find information on permissible cable lengths in the *Cable lengths* section and in the brochure *Interfaces of HEIDENHAIN encoders*.

Ap

The cross section of the supply lines (A_P) serves to determine the voltage drop along the lines (see the *Interfaces of HEIDENHAIN encoders* brochure).

For cables with the prefix "2 x" before the specification of the cable cross section (for example, $2 \times 0.14 \text{ mm}^2$), two wires are available for U_P and GND, respectively. These cables can be used for Remote Sense control. The two wires should be used in parallel.

Application

The "Use with" column lists typical interfaces and applications of the HEIDENHAIN pre-assembled cables. The entered possible applications are only examples. Further applications are possible after consultation with HEIDENHAIN.

Interfaces are indicated where possible with their names or the order designations (possibly in abridged form). For more information, refer to the *Interfaces of HEIDENHAIN Encoders* brochure.







Some product groups are indicated with their product family designations:



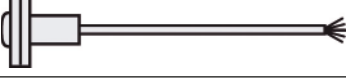

TS/TT: Touch probes
 TL: Laser systems
 ND: Evaluation electronics and digital readouts
 IK: Evaluation electronics
 QUADRA-CHEK: Evaluation electronics

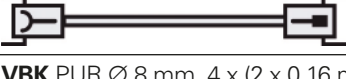
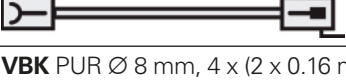
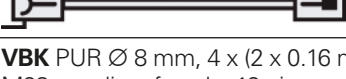
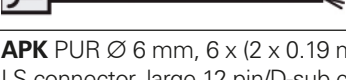
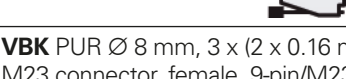
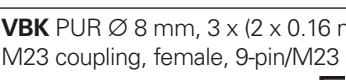
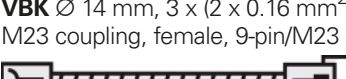
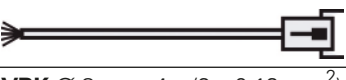





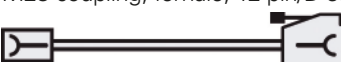
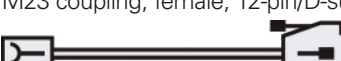
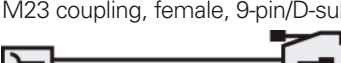
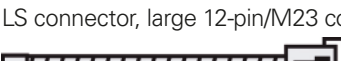
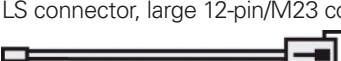

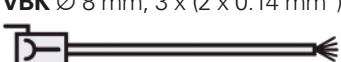
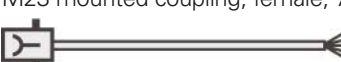
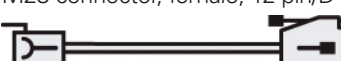
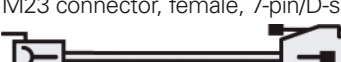

ID		Length	A_P	Application
1130994-xx	APK Ø 8 mm; M12 connector, female, 8-pin/D-sub connector, female, 15-pin 	1 m to 50 m	$2 \times 0.35 \text{ mm}^2$	EnDat22



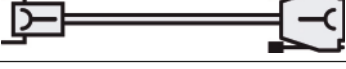







Example from the cable list

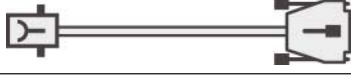

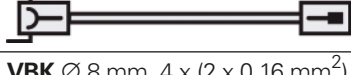

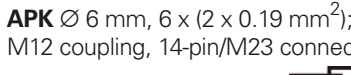
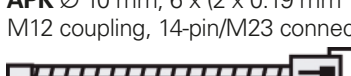
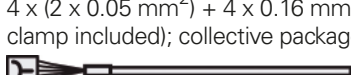
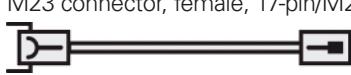

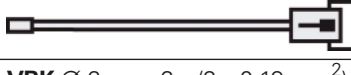

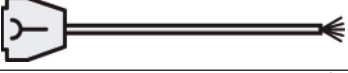

Cable list – sorted by part numbers (ID)

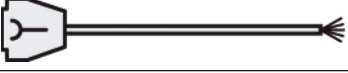



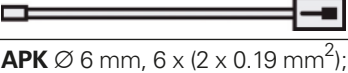

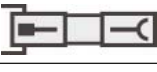
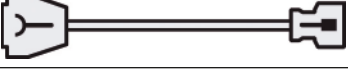





ID		Length	Ap	Application
223775-01	Power cable , PVC, 3 x 1.0 mm ² for digital readouts/evaluation electronics 	3 m	1.0 mm ²	ND
274543-xx	APK PUR Ø 8 mm, 4 x (2 x 0.16 mm ²) + 4 x 0.5 mm ² ; push-pull flange socket, 6-pin/D-sub connector, male, 15-pin 	1 m to 20 m	0.5 mm ²	TS/TT
274544-xx	VBK PUR Ø 8 mm, 4 x (2 x 0.16 mm ²) + 4 x 0.5 mm ² ; push-pull flange socket, 6-pin 	1 m to 20 m	0.5 mm ²	TS/TT
289440-xx	APK PUR Ø 8 mm, 4 x (2 x 0.16 mm ²) + 4 x 0.5 mm ² + 4 x 0.16 mm ² ; M23 connector, female, 17-pin/D-sub connector, female, 25-pin 	1 m to 30 m	2 x 0.5 mm ²	1 V _{PP} + Z1
298399-xx	VBK PUR Ø 8 mm, 4 x (2 x 0.16 mm ²) + 4 x 0.5 mm ² ; M23 connector, female, 12-pin/M23 connector, male, 12-pin 	1 m to 50 m	2 x 0.5 mm ²	1 V _{PP} TTL HTL
298400-xx	VBK PUR Ø 8 mm, 4 x (2 x 0.16 mm ²) + 4 x 0.5 mm ² ; M23 coupling, female, 12-pin/M23 connector, male, 12-pin 	1 m to 50 m	2 x 0.5 mm ²	1 V _{PP} TTL HTL
298401-xx	VBK PUR Ø 8 mm, 4 x (2 x 0.16 mm ²) + 4 x 0.5 mm ² ; M23 connector, female, 12-pin/M23 coupling, male, 12-pin 	1 m to 50 m	2 x 0.5 mm ²	1 V _{PP} TTL HTL
298402-xx	VBK PUR Ø 8 mm, 4 x (2 x 0.16 mm ²) + 4 x 0.5 mm ² ; M23 coupling, female, 12-pin 	1 m to 50 m	2 x 0.5 mm ²	1 V _{PP} TTL HTL
298429-xx	APK PUR Ø 6 mm, 6 x (2 x 0.19 mm ²); LS connector, large 12 pin/D-sub connector, female, 15-pin 	1 m to 9 m	2 x 0.19 mm ²	1 V _{PP} TTL
309773-xx	VBK PUR Ø 8 mm, 3 x (2 x 0.16 mm ²) + 2 x 1.0 mm ² ; M23 connector, female, 9-pin/M23 connector, male, 9-pin 	1 m to 30 m	1.0 mm ²	11 µA _{PP}
309774-xx	VBK PUR Ø 8 mm, 3 x (2 x 0.16 mm ²) + 2 x 1.0 mm ² ; M23 coupling, female, 9-pin/M23 connector, male, 9-pin 	1 m to 30 m	1.0 mm ²	11 µA _{PP}
309775-xx	VBK Ø 14 mm, 3 x (2 x 0.16 mm ²) + 2 x 1.0 mm ² ; M23 coupling, female, 9-pin/M23 connector, male, 9-pin 	1 m to 20 m	1.0 mm ²	11 µA _{PP}
309776-xx	VBK Ø 8 mm, 3 x (2 x 0.16 mm ²) + 2 x 1.0 mm ² ; M23 connector, male, 9-pin 	1 m to 30 m	1.0 mm ²	11 µA _{PP}
309777-xx	VBK Ø 8 mm, 4 x (2 x 0.16 mm ²) + 4 x 0.5 mm ² ; M23 connector, female, 12-pin 	1 m to 50 m	2 x 0.5 mm ²	1 V _{PP} TTL HTL



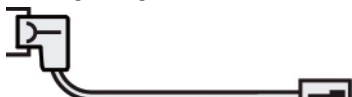
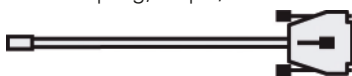



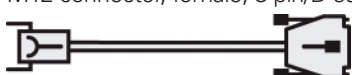

ID		Length	A _p	Application
309778-xx	VBK Ø 8 mm, 4 x (2 x 0.16 mm ²) + 4 x 0.5 mm ² + 4 x 0.16 mm ² ; M23 connector, female, 17-pin 	1 m to 50 m	2 x 0.5 mm ²	EnDat01 EnDat02 SSI..
309779-xx	VBK Ø 8 mm, 4 x (2 x 0.16 mm ²) + 4 x 0.5 mm ² ; M23 connector, female, 17-pin (without 1 V _{PP}) 	1 m to 30 m	2 x 0.5 mm ²	EnDat21 SSI..
309780-xx	VBK Ø 8 mm, 3 x (2 x 0.16 mm ²) + 2 x 1.0 mm ² ; M23 coupling, female, 9-pin 	1 m to 30 m	1.0 mm ²	11 µA _{PP}
309783-xx	APK Ø 8 mm, 4 x (2 x 0.16 mm ²) + 4 x 0.5 mm ² ; M23 coupling, female, 12-pin/D-sub connector, female, 15-pin 	1 m to 50 m	2 x 0.5 mm ²	1 V _{PP} TTL HTL
309784-xx	APK Ø 8 mm, 4 x (2 x 0.16 mm ²) + 4 x 0.5 mm ² ; M23 coupling, female, 12-pin/D-sub connector, male, 15-pin 	0.5 m to 25 m	2 x 0.5 mm ²	1 V _{PP} TTL HTL
309785-xx	APK Ø 8 mm, 3 x (2 x 0.16 mm ²) + 2 x 1.0 mm ² ; M23 coupling, female, 9-pin/D-sub connector, male, 9-pin 	0.5 m to 10 m	1.0 mm ²	11 µA _{PP}
310126-xx	APK Ø 10 mm, 6 x (2 x 0.19 mm ²); LS connector, large 12-pin/M23 connector, male, 12-pin 	1 m to 9 m	2 x 0.19 mm ²	1 V _{PP} TTL
310127-xx	APK Ø 6 mm, 6 x (2 x 0.19 mm ²); LS connector, large 12-pin/M23 connector, male, 12-pin 	1 m to 9 m	2 x 0.19 mm ²	1 V _{PP} TTL
310128-xx	APK Ø 6 mm, 6 x (2 x 0.19 mm ²); LS connector, large 12-pin/M23 coupling, male, 12-pin 	1 m to 9 m	2 x 0.19 mm ²	1 V _{PP} TTL
310131-xx	APK Ø 6 mm, 6 x (2 x 0.19 mm ²); LS connector, large 12-pin 	1 m to 9 m	2 x 0.19 mm ²	1 V _{PP} TTL
310193-xx	VBK Ø 8 mm, 3 x (2 x 0.14 mm ²) + 2 x 0.5 mm ² ; M23 connector, female, 7-pin 	3 m to 40 m	0.5 mm ²	TS/TT
310194-xx	VBK Ø 8 mm, 4 x (2 x 0.16 mm ²) + 4 x 0.5 mm ² ; M23 mounted coupling, female, 7-pin 	1 m to 30 m	0.5 mm ²	TS/TT
310196-xx	APK Ø 8 mm, 4 x (2 x 0.16 mm ²) + 4 x 0.5 mm ² ; M23 connector, female, 12-pin/D-sub connector, male, 15-pin 	0.5 m to 25 m	2 x 0.5 mm ²	1 V _{PP} TTL HTL
310197-xx	APK Ø 8 mm, 3 x (2 x 0.14 mm ²) + 2 x 0.5 mm ² ; M23 connector, female, 7-pin/D-sub connector, male, 15-pin 	1 m to 25 m	0.5 mm ²	TS/TT

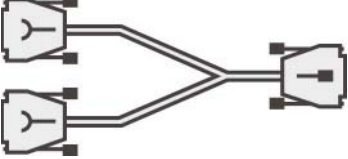



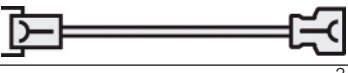

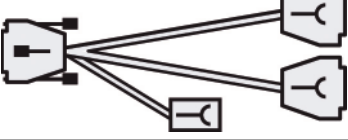
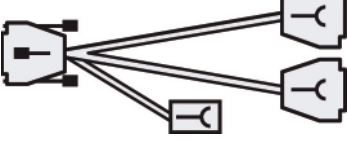

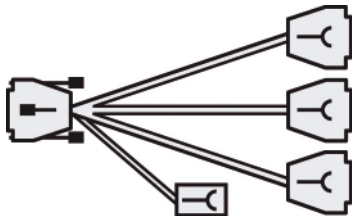
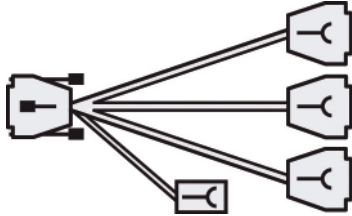

ID		Length	A _p	Application
310199-xx	APK Ø 8 mm, 4 x (2 x 0.16 mm ²) + 4 x 0.5 mm ² ; M23 connector, female, 12-pin/D-sub connector, female, 15-pin 	1 m to 50 m	2 x 0.5 mm ²	1 V _{PP} TTL HTL
313119-01	PUR adapter cable Ø 6 mm, 6 x (2 x 0.19 mm ²); conversion of 11 µA _{PP} → 1 V _{PP} ; D-sub coupling, male, 15-pin/D-sub connector, female, 15-pin 	1 m	0.19 mm ²	11 µA _{PP}
323897-xx	VBK Ø 8 mm, 4 x (2 x 0.16 mm ²) + 4 x 0.5 mm ² + 4 x 0.16 mm ² ; M23 connector, female, 17-pin/M23 coupling, male, 17-pin 	1 m to 50 m	2 x 0.5 mm ²	EnDat01 EnDat02 1 V _{PP} + Z1 SSI..
324544-xx	APK Ø 8 mm, 4 x (2 x 0.16 mm ²) + 4 x 0.5 mm ² + 4 x 0.16 mm ² ; M23 connector, female, 17-pin/D-sub connector, male, 15-pin 	1 m to 25 m	2 x 0.5 mm ²	EnDat01 EnDat02
331693-xx	APK Ø 8 mm, 4 x (2 x 0.16 mm ²) + 4 x 0.5 mm ² ; D-sub connector, female, 15-pin/M23 connector, male, 12-pin 	1 m to 50 m	2 x 0.5 mm ²	1 V _{PP} TTL
332115-xx	APK Ø 8 mm, 4 x (2 x 0.16 mm ²) + 4 x 0.5 mm ² + 4 x 0.16 mm ² ; M23 connector, female, 17-pin/D-sub connector, female, 15-pin 	1 m to 50 m	2 x 0.5 mm ²	EnDat01 EnDat02 SSI..
332199-01	AGK ERN 1387 , Ø 4.5 mm EPG (with shield crimping Ø 6.1 mm), 16 x 0.057 mm ² and polyolefin wires, 2 x 0.25 mm ² for temperature sensor; 14-pin PCB connector/ M23 right-angle flange socket, male, 17-pin; collective package upon request 	0.3 m	2 x 0.057 mm ²	1 V _{PP}
332200-01 332200-04	AGK ERN 1387 , Ø 4.5 mm EPG (with shield crimping Ø 6.1 mm) 16 x 0.057 mm ² ; 14-pin PCB connector/cable cut off; collective package upon request 	0.3 m 1 m	2 x 0.057 mm ²	1 V _{PP}
332201-01	AGK ECN 1313/EQN 1325/ECI 1319/EQI 1331 , Ø 4.5 mm EPG (with shield crimping Ø 6.1 mm), 16 x 0.057 mm ² and polyolefin wires, 2 x 0.25 mm ² for temperature sensor; 12-pin PCB connector/M23 right-angle flange socket, male, 17-pin; collective package upon request 	0.3 m	2 x 0.057 mm ²	EnDat01
332202-01	AGK ECN 1313/EQN 1325/ECI 1319/EQI 1331 , Ø 4.5 mm EPG (with shield crimping Ø 6.1 mm), 16 x 0.057 mm ² ; 12-pin PCB connector/cable cut off; collective package upon request 	0.3 m	2 x 0.057 mm ²	EnDat01
332433-xx	VBK Ø 8 mm, 4 x (2 x 0.16 mm ²) + 4 x 0.5 mm ² ; D-sub connector, female, 15-pin 	1 m to 50 m	2 x 0.5 mm ²	1 V _{PP} TTL
333276-01	AGK ERN 1381/ERN 1321 , Ø 4.5 mm EPG (with shield crimping Ø 6.1 mm), 16 x 0.057 mm ² ; 12-pin PCB connector/cable cut off; collective package upon request 	0.3 m	2 x 0.057 mm ²	1 V _{PP} TTL









ID		Length	A _p	Application
335074-xx	VBK Ø 8 mm, 4 x (2 x 0.16 mm ²) + 4 x 0.5 mm ² ; D-sub connector, female, 15-pin/D-sub connector, male, 15-pin 	1 m to 50 m	2 x 0.5 mm ²	1 V _{PP} TTL
335077-xx	APK Ø 8 mm, 4 x (2 x 0.16 mm ²) + 4 x 0.5 mm ² ; D-sub connector, female, 15-pin/D-sub connector, female, 15-pin 	1 m to 50 m	2 x 0.5 mm ²	1 V _{PP} TTL
335332-xx	APK Ø 8 mm, 4 x (2 x 0.16 mm ²) + 4 x 0.5 mm ² ; M23 mounted coupling, female, 7-pin/D-sub connector, male, 9-pin 	0.5 m to 40 m	0.5 mm ²	TS/TT
336376-xx	APK Ø 8 mm, 4 x (2 x 0.16 mm ²) + 4 x 0.5 mm ² + 4 x 0.16 mm ² ; M23 connector, female, 17-pin/D-sub connector, female, 25-pin 	1 m to 50 m	2 x 0.5 mm ²	EnDat01 EnDat02 SSI..
336847-xx	VBK Ø 8 mm, 4 x (2 x 0.16 mm ²) + 4 x 0.5 mm ² + 4 x 0.16 mm ² ; M23 connector, female, 17-pin/M23 coupling, male, 17-pin 	1 m to 50 m	2 x 0.5 mm ²	1 V _{PP} + Z1
340302-xx	VBK Ø 8 mm, 4 x (2 x 0.16 mm ²) + 4 x 0.5 mm ² + 4 x 0.16 mm ² ; M23 connector, female, 17-pin/M23 coupling, male, 17-pin 	1 m to 50 m	2 x 0.5 mm ²	EnDat01 EnDat02 SSI..
341369-01	AGK ERN 1326 , Ø 4.5 mm EPG (with shield crimping Ø 6.1 mm), 16 x 0.057 mm ² ; 16-pin PCB connector/cable cut off; collective package upon request 	0.3 m	2 x 0.057 mm ²	TTL
344228-xx	APK Ø 6 mm, 6 x (2 x 0.19 mm ²); M12 coupling, 14-pin/M23 connector, male, 12-pin 	1 m to 9 m	2 x 0.19 mm ²	1 V _{PP} TTL
344451-xx	APK Ø 10 mm, 6 x (2 x 0.19 mm ²); M12 coupling, 14-pin/M23 connector, male, 12-pin 	1 m to 9 m	2 x 0.19 mm ²	1 V _{PP} TTL
346439-01	AGK ERO 14x0 , PUR Ø 4.5 mm (with shield crimping Ø 4.3 mm), 4 x (2 x 0.05 mm ²) + 4 x 0.16 mm ² ; PCB connector, 12-pin/cable cut off (cable clamp included); collective package upon request 	1 m	2 x 0.16 mm ²	1 V _{PP} TTL
349314-xx	VBK Ø 8 mm, 1 x (4 x 0.16 mm ²) + 4 x 1.0 mm ² ; M23 connector, female, 17-pin/M23 coupling, male, 17-pin 	1 m to 15 m	2 x 1.0 mm ²	Fanuc.. Mit..
349687-xx	APK Ø 6 mm, 6 x (2 x 0.19 mm ²); D-sub connector, female, 15-pin/D-sub connector, female, 15-pin 	1 m to 7 m	2 x 0.19 mm ²	1 V _{PP} TTL
352611-xx	APK Ø 4.5 mm, 4 x (2 x 0.05 mm ²) + 4 x 0.16 mm ² ; M12 coupling, 14-pin/M23 connector, male, 12-pin 	1 m to 9 m	2 x 0.16 mm ²	1 V _{PP} TTL
354319-xx	VBK Ø 6 mm, 6 x (2 x 0.19 mm ²); M12 coupling, 14-pin 	1 m to 15 m	2 x 0.19 mm ²	1 V _{PP} TTL





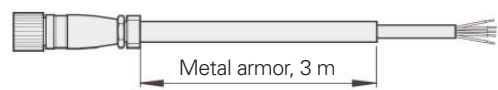
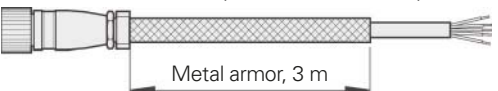

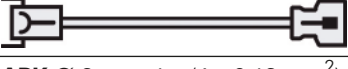
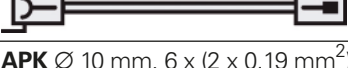
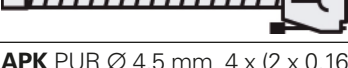
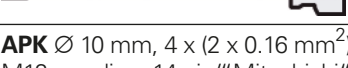
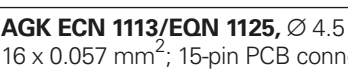

ID		Length	Ap	Application
354379-xx	VBK Ø 8 mm, 6 x 2 x 0.16 mm ² + 4 x 0.5 mm ² ; D-sub connector, female, 15-pin/D-sub connector, male, 15-pin 	1 m to 20 m	2 x 0.5 mm ²	1 V _{PP} TTL
354411-xx	VBK Ø 8 mm, 6 x 2 x 0.16 mm ² + 4 x 0.5 mm ² ; D-sub connector, female, 15-pin 	1 m to 20 m	2 x 0.5 mm ²	1 V _{PP} TTL
355186-xx	VBK Ø 6 mm, 6 x (2 x 0.19 mm ²); D-sub connector, female, 15-pin/D-sub connector, male, 15-pin 	1 m to 7 m	2 x 0.19 mm ²	1 V _{PP} TTL
355209-xx	VBK Ø 6 mm, 6 x (2 x 0.19 mm ²); D-sub connector, female, 15-pin 	1 m to 7 m	2 x 0.19 mm ²	1 V _{PP} TTL
355215-xx	APK Ø 6 mm, 6 x (2 x 0.19 mm ²); D-sub connector, female, 15-pin/M23 connector, male, 12-pin 	1 m to 7 m	2 x 0.19 mm ²	1 V _{PP} TTL
355397-xx	VBK Ø 6 mm, 6 x (2 x 0.09 mm ²) + 4 x 0.16 mm ² ; D-sub connector, female, 15-pin/D-sub connector, male, 15-pin 	1 m to 7 m	2 x 0.16 mm ²	1 V _{PP} TTL
355398-xx	VBK Ø 6 mm, 6 x (2 x 0.09 mm ²) + 4 x 0.16 mm ² ; D-sub connector, female, 15-pin 	1 m to 7 m	2 x 0.16 mm ²	1 V _{PP} TTL
360645-xx	APK Ø 6 mm, 6 x (2 x 0.19 mm ²); M12 coupling, 14-pin/M23 coupling, male, 12-pin 	1 m to 9 m	2 x 0.19 mm ²	1 V _{PP} TTL
360974-xx	APK Ø 6 mm, 6 x (2 x 0.19 mm ²); M12 coupling, 14-pin/D-sub connector, female, 15-pin 	1 m to 15 m	2 x 0.19 mm ²	1 V _{PP} TTL
364914-01	Adapter connector , conversion of 1 V _{PP} → 11 μA _{PP} ; M23 connector, female, 12-pin/M23 connector, male, 9-pin 	–	–	1 V _{PP}
364914-02	Adapter connector , conversion from 1 V _{PP} → 11 μA _{PP} ; M23 coupling, female, 12-pin/M23 connector, male, 9-pin 	–	–	1 V _{PP}
366419-xx	APK Ø 6 mm, 2 x (2 x 0.16 mm ²) + 4 x 0.5 mm ² ; D-sub connector, female, 15-pin/"Mitsubishi" connector, male, 20-pin 	1 m to 30 m	2 x 0.5 mm ²	Mit..
366964-xx	RS 232 cable (V.24) for ND 280, ND 780, PT 880, PUR Ø 6 mm, 6 x (2 x 0.19 mm ²); D-sub connector, male, 9-pin/D-sub connector, female, 9-pin 	3 m 5 m 10 m	2 x 0.19 mm ²	ND
367958-xx	APK Ø 6 mm, 2 x (2 x 0.16 mm ²) + 4 x 0.5 mm ² ; M23 connector, female, 17-pin/"Mitsubishi" connector, male, 20-pin 	1 m to 25 m	2 x 0.5 mm ²	Mit..



ID		Length	A _p	Application
368017-xx	RS 232 cable (V.24) for ND 280, ND 780, PT 880, PVC Ø 7.1 mm, 8 x 0.25 mm ² ; D-sub connector, male, 25-pin/D-sub connector, female, 9-pin 	3 m 5 m 10 m	0.25 mm ²	ND
368172-xx	APK Ø 8 mm, 3 x (2 x 0.16 mm ²) + 2 x 1.0 mm ² ; M23 coupling, female, 9-pin/D-sub connector, female, 15-pin 	1 m to 10 m	1.0 mm ²	11 µA _{pp}
368330-xx	VBK Ø 6 mm, 1 x (4 x 0.16 mm ²) + 4 x 0.34 mm ² ; M12 connector, female, 8-pin/M12 coupling, male, 8-pin 	1 m to 50 m	2 x 0.34 mm ²	EnDat22 Fanuc.. Mit.. TS/TT
372164-01	AGK ERO 12x5, ERP 880 , PUR Ø 4.5 mm (with shield crimping Ø 4.3 mm), 4 x (2 x 0.05 mm ²) + 4 x 0.16 mm ² ; PCB connector, 12-pin (Hirose)/cable cut off (cable clamp included); collective package upon request 	1 m	2 x 0.16 mm ²	1 V _{PP} TTL
372978-xx	APK Ø 8 mm, 4 x (2 x 0.16 mm ²) + 4 x 0.5 mm ² ; D-sub connector, female, 15-pin/M23 coupling, male, 12-pin 	1 m to 30 m	2 x 0.5 mm ²	1 V _{PP} TTL
372979-xx	APK Ø 6 mm, 6 x (2 x 0.19 mm ²); D-sub connector, female, 15-pin/M23 coupling, male, 12-pin 	1 m to 7 m	2 x 0.19 mm ²	1 V _{PP} TTL
373289-xx	VBK Ø 6 mm, 1 x (4 x 0.16 mm ²) + 4 x 0.34 mm ² ; M12 right-angle connector, female, 8-pin/M12 coupling, male, 8-pin 	1 m to 50 m	2 x 0.34 mm ²	EnDat22 Fanuc.. Mit..
387287-xx	APK Ø 6 mm, 6 x (2 x 0.19 mm ²); M12 coupling, 14-pin/D-sub connector, male, 15-pin 	1 m to 15 m	2 x 0.19 mm ²	1 V _{PP} TTL
509667-xx	APK Ø 8 mm, 4 x (2 x 0.16 mm ²) + 4 x 0.5 mm ² + 4 x 0.14 mm ² ; M23 connector, female, 17-pin/D-sub connector, female, 25-pin 	1 m to 50 m	2 x 0.5 mm ²	EnDat01 EnDat02
517375-xx	APK Ø 4.5 mm, 4 x (2 x 0.05 mm ²) + 1 x 0.05 mm ² ; M23 coupling, male, 7-pin 	1 m to 5 m	0.05 mm ²	TS/TT
517376-xx	APK Ø 4.5 mm, 4 x (2 x 0.05 mm ²) + 1 x 0.05 mm ² ; D-sub connector, male, 15-pin 	6 m to 30 m	0.05 mm ²	TS/TT
524599-xx	APK Ø 6 mm, 1 x (4 x 0.16 mm ²) + 4 x 0.34 mm ² ; M12 connector, female, 8-pin/D-sub connector, male, 15-pin 	1 m to 50 m	2 x 0.34 mm ²	EnDat22 Fanuc.. Mit..
532856-xx	VBK PVC Ø 10.5 mm, 12 x (2 x 0.09 mm ²) + 1 x 0.09 mm ² ; for connecting the IOB 89 to PT 880; D-sub connector, male, 25-pin/D-sub connector, male, 37-pin 	1 m to 10 m	0.09 mm ²	ND



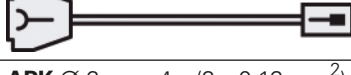
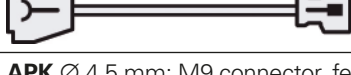

ID		Length	A _p	Application
532899-xx	VBK PVC, gray color, 2 x (2 x 0.35 mm ²); for connecting the IOB 49 to ND 780; D-sub connector, male, 15-pin/D-sub connector, male, 15-pin 	1 m to 15 m	0.35 mm ²	ND
532909-01	Y cable (VBK) PVC, gray color, 8 x 0.25 mm ² ; complete, for simultaneous connection of IOB 49 and KT 130 to ND 780 	0.15 m	0.25 mm ²	ND
533627-xx	APK Ø 6 mm, 1 x (4 x 0.16 mm ²) + 4 x 0.34 mm ² ; M12 connector, female, 8-pin/D-sub connector, female, 15-pin 	1 m to 50 m	2 x 0.34 mm ²	EnDat22
533631-xx	APK Ø 6 mm, 6 x (2 x 0.19 mm ²); M12 coupling, 14-pin/M23 coupling, male, 17-pin 	1 m to 9 m	2 x 0.19 mm ²	EnDat01 EnDat02 SSI..
533661-xx	APK Ø 4.5 mm, 4 x (2 x 0.16 mm ²); M12 coupling, 14-pin/M12 coupling, male, 8-pin 	1 m to 20 m	2 x 0.16 mm ²	EnDat22 Fanuc.. Mit..
534855-xx	APK Ø 8 mm, 2 x (2 x 0.16 mm ²) + 4 x 1.0 mm ² ; M23 connector, female, 17-pin/"Fanuc" connector, female, 15-pin 	1 m to 30 m	2 x 1.0 mm ²	Fanuc..
539878-xx	APK Ø 10 mm, 6 x (2 x 0.19 mm ²); M12 coupling, 14-pin/D-sub connector, female, 15-pin 	1 m to 20 m	2 x 0.19 mm ²	1 V _{PP} TTL
540540-05	APK 2 x TTL with D-sub connector, female, 9-pin and for foot switch with Mini-DIN connector, female, 3-pin 	2 x 1 m and 1 x 0.15 m	0.25 mm ²	IK
540540-24	APK 2 x 1 V _{PP} with D-sub connector, female, 15-pin and for foot switch with Mini-DIN connector, female, 3-pin 	2 x 1 m and 1 x 0.15 m	0.25 mm ²	IK
540541-05	APK 1 x TTL with D-sub connector, female, 9-pin 	1 m	0.25 mm ²	IK
540541-24	APK 1 x V _{PP} with D-sub connector, female, 15-pin 	1 m	0.25 mm ²	IK

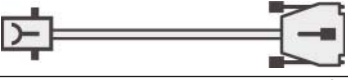
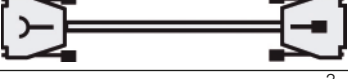
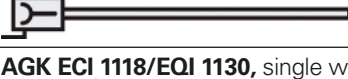
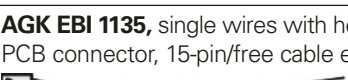
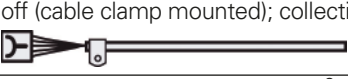
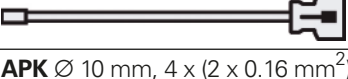
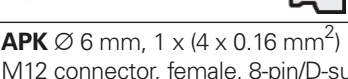
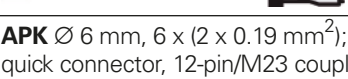
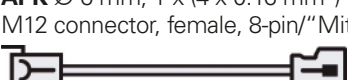
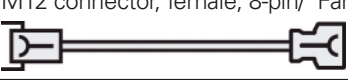





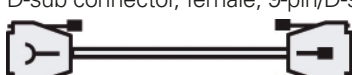
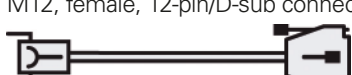
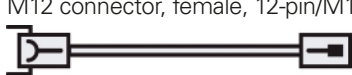

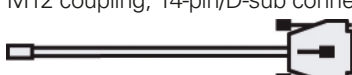
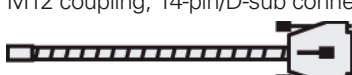
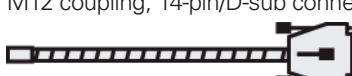
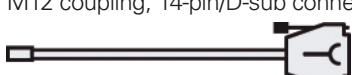
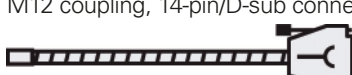



ID		Length	A _p	Application
540550-10	APK 3 x TTL with D-sub connector, female, 9-pin and for foot switch with Mini-DIN connector, female, 3-pin 	3 x 1 m and 1 x 0.15 m	0.25 mm ²	IK
540550-40	APK 3 x 1 V _{PP} with D-sub connector, female, 15-pin and for foot switch with Mini-DIN connector, female, 3-pin 	3 x 1 m and 1 x 0.15 m	0.25 mm ²	IK
540660-05	VBK PVC Ø 5.1 mm, 6 x 0.25 mm ² ; for communication between ND 1000/ND 2000 and a PC with QUADRA-CHEK Wedge; D-sub connector, female, 9-pin 	3 m	–	ND
540660-53	VBK PVC color gray; for connecting the joystick to the amplifier for the IK 5xxx; D-sub connector, female, 15-pin/D-sub connector, male, 15-pin 	3 m	–	IK
540660-56	VBK PVC color gray; for connecting the CNC amplifier to the IK 5xxx (included in the items supplied with the amplifier); D-sub connector, male, 26-pin/D-sub connector, male, 26-pin 	3 m	–	IK
545547-xx	APK Ø 4.5 mm, 4 x (2 x 0.16 mm ²); M12 coupling, 14-pin/"Fanuc" connector, female, 15-pin 	1 m to 20 m	2 x 0.16 mm ²	Fanuc..
547300-xx	APK Ø 4.5 mm, 4 x (2 x 0.16 mm ²); M12 coupling, 14-pin/M23 coupling, male, 17-pin 	1 m to 9 m	2 x 0.16 mm ²	EnDat22 Fanuc.. Mit..
550678-xx	APK Ø 10 mm, 4 x (2 x 0.16 mm ²); M12 coupling, 14-pin/M12 coupling, male, 8-pin 	1 m to 20 m	2 x 0.16 mm ²	EnDat22 Fanuc.. Mit..
551027-xx	APK Ø 10 mm, 4 x (2 x 0.16 mm ²); M12 coupling, 14-pin/"Fanuc" connector, female, 15-pin 	1 m to 20 m	2 x 0.16 mm ²	Fanuc..
555541-xx	APK Ø 10 mm, 4 x (2 x 0.16 mm ²); M12 coupling, 14-pin/M23 coupling, male, 17-pin 	1 m to 9 m	2 x 0.16 mm ²	EnDat22 Fanuc.. Mit..
556558-xx	APK Ø 8 mm, 4 x (2 x 0.16 mm ²) + 4 x 0.5 mm ² ; M23 connector, female, 12-pin/"Fanuc" connector, female, 15-pin 	1 m to 30 m	2 x 0.5 mm ²	Fanuc..







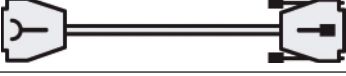



ID		Length	Ap	Application
558362-xx	APK Ø 10 mm, 6 x (2 x 0.19 mm ²); M12 coupling, 14-pin/M23 coupling, male, 17-pin 	1 m to 9 m	2 x 0.19 mm ²	EnDat01 EnDat02 SSI..
558714-xx	APK Ø 6 mm, 6 x (2 x 0.19 mm ²); M12 coupling 14-pin/D-sub connector, female, 15-pin 	1 m to 20 m	2 x 0.19 mm ²	EnDat01 EnDat02 SSI..
558727-xx	APK Ø 6 mm, 6 x (2 x 0.19 mm ²); M12 coupling, 14-pin/D-sub connector, female, 25-pin 	1 m to 20 m	2 x 0.19 mm ²	EnDat01 EnDat02 SSI..
560039-01	VBK 4 x 0.75 mm² ; D-sub connector, 9-pin with interface for TNC 320, TNC 426/430, iTNC 530 	5 m	0.75 mm ²	TL
560040-xx	APK Ø 6.5 mm/14 mm, color green, 6 x 0.14 mm ² + 2 x 0.5 mm ² ; circular connector, 12-pin, with 3 m PUR protective sleeve 	10 m 20 m	0.5 mm ²	TL
560041-xx	APK Ø 6.5 mm/14 mm, color green, 6 x 0.14 mm ² + 2 x 0.5 mm ² ; circular connector, 12-pin, with 3 m PUR protective sleeve and steel braiding 	10 m 20 m	0.5 mm ²	TL
572822-xx	APK Ø 8 mm, 4 x (2 x 0.16 mm ²) + 4 x 0.5 mm ² ; M23 coupling, female, 12-pin/"Fanuc" connector, female, 15-pin 	1 m to 30 m	2 x 0.5 mm ²	Fanuc..
573661-xx	APK Ø 8 mm, 2 x (2 x 0.16 mm ²) + 4 x 1.0 mm ² ; M23 connector, female, 17-pin/"Mitsubishi" connector, male, 10-pin 	1 m to 30 m	2 x 1.0 mm ²	Mit..
582333-xx	APK Ø 6 mm, 1 x (4 x 0.16 mm ²) + 4 x 0.34 mm ² ; M12 connector, female, 8-pin/M23 coupling, male, 17-pin 	1 m to 30 m	2 x 0.34 mm ²	EnDat22 Fanuc.. Mit..
588552-xx	APK Ø 10 mm, 6 x (2 x 0.19 mm ²); LS connector, large, 12 pin/D-sub connector, female, 15-pin 	1 m to 20 m	2 x 0.19 mm ²	1 V _{PP} TTL
599685-xx	APK PUR Ø 4.5 mm, 4 x (2 x 0.16 mm ²); M12 coupling, 14-pin/"Mitsubishi" connector, male, 20-pin 	1 m to 9 m	2 x 0.16 mm ²	Mit..
599688-xx	APK Ø 10 mm, 4 x (2 x 0.16 mm ²); M12 coupling, 14-pin/"Mitsubishi" connector, male, 20-pin 	1 m to 9 m	2 x 0.16 mm ²	Mit..
605090-01 605090-02	AGK ECN 1113/EQN 1125 , Ø 4.5 mm EPG (with shield crimping Ø 4.3 mm), 16 x 0.057 mm ² ; 15-pin PCB connector/cable cut off; collective package upon request 	0.3 m 2 m	2 x 0.057 mm ²	EnDat01

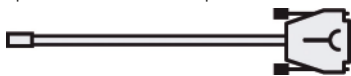
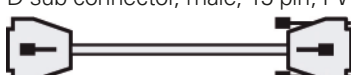
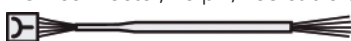







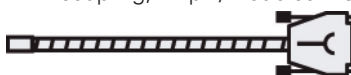



ID		Length	A _p	Application
606079-01	AGK ECN 1113/EQN 1125 , Ø 4.5 mm EPG (with shield crimping Ø 4.3 mm), 16 x 0.057 mm ² and polyolefin wires, 2 x 0.25 mm ² for temperature sensor; 15-pin PCB connector/M23 right-angle flange socket, male, 17-pin 	0.3 m	2 x 0.057 mm ²	EnDat01
606317-xx	VBK Ø 6 mm, 1 x (4 x 0.16 mm ²) + 4 x 0.34 mm ² ; M12 connector, female, 8-pin right-angle/free cable end, cut off 	1 m to 50 m	2 x 0.34 mm ²	EnDat22 TS/TT
617484-xx	APK in braiding Ø 6.6 mm, 6 x (2 x 0.19 mm ²); M12 coupling, 14-pin/D-sub connector, male, 9-pin 	1 m to 9 m	2 x 0.19 mm ²	TTL
617513-xx	APK Ø 8 mm, 4 x (2 x 0.16 mm ²) + 4 x 0.5 mm ² ; M23 coupling, female, 12-pin/D-sub connector, male, 9-pin 	1 m to 30 m	2 x 0.5 mm ²	TTL
621742-01	AGK ECI 11xx/ECI 13xx/EQI 11xx/EQI 13xx/ExN 11xx/ExN 13xx , Ø 4.5 mm EPG 16 x 0.057 mm ² ; PCB connector with strain relief 12-pin/D-sub connector, male, 15-pin incl. 3 adapter cnnctrs. 12-pin and 3 adapter cnnctrs. 15-pin; test cable to PWM 2x 	2 m	2 x 0.057 mm ²	EnDat01 EnDat22
626015-xx	APK Ø 8 mm, 4 x (2 x 0.16 mm ²) + 4 x 0.5 mm ² ; M23 connector, female, 12-pin/D-sub connector, male, 9-pin 	1 m to 50 m	2 x 0.5 mm ²	TTL
628184-xx	APK Ø 6 mm, 2 x (2 x 0.16 mm ²) + 4 x 0.5 mm ² ; D-sub connector, female, 15-pin/"Fanuc" connector, female, 15-pin 	1 m to 30 m	2 x 0.5 mm ²	Fanuc..
628186-xx	APK Ø 6 mm, 1 x (4 x 0.16 mm ²) + 4 x 0.34 mm ² ; D-sub connector, female, 15-pin/M12 coupling, male, 8-pin 	1 m to 50 m	2 x 0.34 mm ²	EnDat22 Fanuc.. Mit..
630856-xx	APK Ø 6 mm, 4 x (2 x 0.16 mm ²) + 4 x 0.5 mm ² ; D-sub connector, female, 15-pin/"Mitsubishi" connector, male, 10-pin 	1 m to 30 m	2 x 0.5 mm ²	Mit..
633608-xx	APK Ø 4.5 mm; M9 connector, female, 8-pin/D-sub connector, male, 15-pin 	1 m to 30 m	0.09 mm ²	TS/TT
633611-xx	APK Ø 6 mm, 6 x (2 x 0.19 mm ²); M23 connector, female, 7-pin/D-sub connector, male, 15-pin 	1 m to 25 m	0.09 mm ²	TS/TT









ID		Length	Ap	Application
633613-xx	APK Ø 8 mm, 4 x (2 x 0.16 mm ²) + 4 x 0.5 mm ² ; push-pull flange socket, 6-pin/D-sub connector, male, 15-pin 	1 m to 20 m	0.19 mm ²	TS/TT
633616-xx	APK Ø 6 mm, 6 x (2 x 0.19 mm ²); M23 mounted coupling, female, 7-pin/D-sub connector, male, 15-pin 	1 m to 40 m	0.09 mm ²	TS/TT
633811-xx	VBK Ø 6 mm, 6 x (2 x 0.09 mm ²) + 4 x 0.16 mm ² ; D-sub connector, female, 15-pin/D-sub connector, male, 15-pin 	1 m to 10 m	2 x 0.16 mm ²	1 V _{PP} TTL
634265-xx	VBK Ø 6 mm, 1 x (4 x 0.16 mm ²) + 4 x 0.34 mm ² ; M12 connector, female, 8-pin/free cable end, cut off 	1 m to 50 m	2 x 0.34 mm ²	EnDat22
640030-01	AGK ECI 1118/EQI 1130 , single wires with heat-shrink tubing (without shield), 12 x 0.16 ² ; PCB connector, 15-pin/free cable end; collective package upon request 	0.15 m	2 x 0.16 mm ²	EnDat01
640055-01	AGK EBI 1135 , single wires with heat-shrink tubing (without shield), 8 x 0.16 mm ² ; PCB connector, 15-pin/free cable end; collective package upon request 	0.15 m	2 x 0.16 mm ²	EnDat22
640067-N3	AGK ECI 119 , Ø 4.5 mm EPG, 16 x 0.057 mm ² ; PCB connector, 15-pin/cable cut off (cable clamp mounted); collective package upon request 	0.3 m	2 x 0.057 mm ²	EnDat01
640915-xx	APK Ø 6 mm, 4 x (2 x 0.16 mm ²); M12 coupling, 14-pin/"Mitsubishi" connector, male, 10-pin 	1 m to 9 m	2 x 0.16 mm ²	Mit..
640916-xx	APK Ø 10 mm, 4 x (2 x 0.16 mm ²); M12 coupling, 14-pin/"Mitsubishi" connector, male, 10-pin 	1 m to 9 m	2 x 0.16 mm ²	Mit..
641926-xx	APK Ø 6 mm, 1 x (4 x 0.16 mm ²) + 4 x 0.34 mm ² ; M12 connector, female, 8-pin/D-sub connector, female, 25-pin 	1 m to 50 m	2 x 0.34 mm ²	EnDat22
643450-xx	APK Ø 6 mm, 6 x (2 x 0.19 mm ²); quick connector, 12-pin/M23 coupling,, male, 17-pin 	1 m to 20 m	2 x 0.19 mm ²	EnDat02
646806-xx	APK Ø 6 mm, 1 x (4 x 0.16 mm ²) + 4 x 0.34 mm ² ; M12 connector, female, 8-pin/"Mitsubishi" connector, male, 20-pin 	1 m to 30 m	2 x 0.34 mm ²	Mit..
646807-xx	APK Ø 6 mm, 1 x (4 x 0.16 mm ²) + 4 x 0.34 mm ² ; M12 connector, female, 8-pin/"Fanuc" connector, female, 15-pin 	1 m to 30 m	2 x 0.34 mm ²	Fanuc..
647314-xx	APK Ø 6 mm, 1 x (4 x 0.16 mm ²) + 4 x 0.34 mm ² ; M12 connector, female, 8-pin/"Mitsubishi" connector, male, 10-pin 	1 m to 30 m	2 x 0.34 mm ²	Mit..







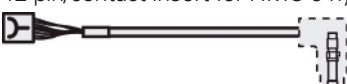
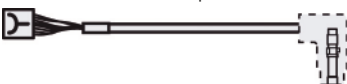

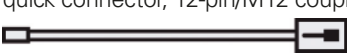



ID		Length	A _p	Application
653231-xx	APK Ø 8 mm, 3 x (2 x 0.16 mm ²) + 2 x 1.0 mm ² ; M23 coupling, female, 9-pin/D-sub connector, male, 15-pin 	0.2 m 1 m to 10 m	1.0 mm ²	11 µA _{PP}
660042-xx	VBK Ø 10 mm, 1 x (4 x 0.16 mm ²) + 4 x 0.34 mm ² ; M12 connector, female, 8-pin/M12 coupling, male, 8-pin 	1 m to 50 m	0.34 mm ²	TS/TT
663508-xx	VBK Ø 8 mm, 3 x (2 x 0.14 mm ²) + 2 x 0.5 mm ² ; D-sub connector, female, 15-pin/D-sub connector (pin) 15-pin 	1 m to 10 m	0.5 mm ²	TS/TT
663511-xx	VBK Ø 8 mm, 4 x (2 x 0.16 mm ²) + 4 x 0.5 mm ² ; D-sub connector, female, 9-pin/D-sub connector, male, 9-pin 	1 m to 10 m	0.5 mm ²	TS/TT
663631-xx	APK Ø 6 mm, 6 x (2 x 0.19 mm ²); M12, female, 12-pin/D-sub connector, male, 15-pin 	1 m to 20 m	0.19 mm ²	TS/TT
664211-xx	VBK Ø 6 mm, 6 x (2 x 0.19 mm ²); M12 connector, female, 12-pin/M12 coupling, male, 12-pin 	1 m to 20 m	0.19 mm ²	TS/TT
667343-01	AGK ERN 1381/ERN 1321 , Ø 4.5 mm EPG (with shield crimping Ø 6.1 mm), 16 x 0.057 mm ² and polyolefin wires, 2 x 0.25 mm ² for temperature sensor; 12-pin PCB connector/M23 right-angle flange socket, male, 17-pin 	0.3 m	2 x 0.057 mm ²	1 V _{PP} TTL
667607-xx	APK Ø 4.5 mm, 4 x (2 x 0.16 mm ²); M12 coupling, 14-pin/D-sub connector, male, 15-pin 	1 m to 20 m	2 x 0.16 mm ²	EnDat22
667608-xx	APK Ø 10 mm, 4 x (2 x 0.16 mm ²); M12 coupling, 14-pin/D-sub connector, male, 15-pin 	1 m to 20 m	2 x 0.16 mm ²	EnDat22
672625-xx	APK Ø 10 mm, 6 x (2 x 0.19 mm ²); M12 coupling, 14-pin/D-sub connector, male, 15-pin 	1 m to 20 m	2 x 0.19 mm ²	1 V _{PP} TTL
673459-xx	APK Ø 4.5 mm, 4 x (2 x 0.16 mm ²); M12 coupling, 14-pin/D-sub connector, female, 15-pin 	1 m to 20 m	2 x 0.16 mm ²	EnDat22
673461-xx	APK Ø 10 mm, 4 x (2 x 0.16 mm ²); M12 coupling, 14-pin/D-sub connector, female, 15-pin 	1 m to 20 m	2 x 0.16 mm ²	EnDat22







ID		Length	Ap	Application
675582-xx	VBK Ø 8 mm, 4 x (2 x 0.16 mm ²) + 4 x 0.5 mm ² + 4 x 0.16 mm ² ; D-sub connector, female, 15-pin/D-sub connector, male, 15-pin 	1 m to 50 m	2 x 0.5 mm ²	1 V _{PP} + Z1
679671-xx	APK Ø 4.5 mm, 4 x (2 x 0.16 mm ²); quick connector, 12-pin/M12 coupling, male, 8-pin 	1 m to 20 m	2 x 0.16 mm ²	EnDat22 Fanuc.. Mit..
680856-xx	VBK Ø 4.5 mm, 4 x (2 x 0.16 mm ²); quick connector, 12-pin 	1 m to 20 m	2 x 0.16 mm ²	EnDat22 Fanuc.. Mit..
681186-xx	VBK Ø 6 mm, 6 x (2 x 0.19 mm ²); quick connector, 12-pin 	1 m to 20 m	2 x 0.19 mm ²	EnDat02
701919-xx	APK Ø 8 mm, 3 x (2 x 0.14 mm ²) + 2 x 0.5 mm ² ; D-sub connector, female, 3-row, 15-pin/D-sub connector, male, 2-row, 15-pin 	1 m to 20 m	0.5 mm ²	TS/TT
716905-0A	APK Ø 8 mm, 3 x (2 x 0.16 mm ²) + 2 x 1.0 mm ² ; M23 coupling, female, 9-pin/D-sub connector, male, 9-pin 	0.5 m	1.0 mm ²	11 µApp
722025-xx	APK Ø 6 mm, 1 x (4 x 0.16 mm ²) + 4 x 0.34 mm ² ; M12 connector, female, 8-pin, right-angle/D-sub connector, male, 15-pin 	1 m to 10 m	2 x 0.34 mm ²	EnDat22
727658-xx	APK Ø 6 mm, 6 x (2 x 0.19 mm ²); quick connector 12-pin/D-sub connector, female, 15-pin 	1 m to 20 m	2 x 0.19 mm ²	EnDat01 EnDat02
729681-xx	APK Ø 4.5 mm, 1 x (4 x 0.09 mm ²) + 4 x 0.16 mm ² ; quick connector, 12-pin/M12 coupling, male, 8-pin 	1 m to 20 m	2 x 0.16 mm ²	EnDat22 Fanuc.. Mit..
735210-xx	APK Ø 4.5 mm, 4 x (2 x 0.05 mm ²) + 4 x 0.16 mm ² ; M12 coupling, 14-pin/D-sub connector, male, 9-pin 	1 m to 9 m	2 x 0.16 mm ²	TTL
735541-xx	VBK Ø 8 mm, 6 x (2 x 0.16 mm ²) + 4 x 0.5 mm ² ; D-sub connector, female, 15-pin/ D-sub connector, male, 15-pin with programming line for mounting the LIP 2xx 	1 m to 6 m	2 x 0.5 mm ²	1 V _{PP} TTL
735784-01	AGK ECI 1118 , single wires with heat-shrink tubing (without shield), 6 x 0.16 mm ² ; PCB connector, 15-pin/free cable end; collective package upon request 	0.15 m	2 x 0.16 mm ²	EnDat22
735961-xx	APK Ø 6 mm, 6 x (2 x 0.19 mm ²); quick connector 12-pin/D-sub connector, female, 25-pin 	1 m to 20 m	2 x 0.19 mm ²	EnDat02





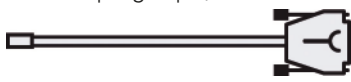
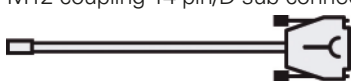

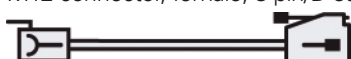
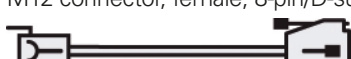
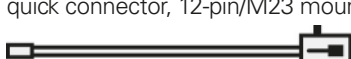

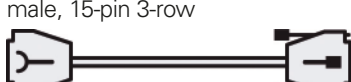
ID		Length	A _p	Application
735987-xx	APK Ø 4.5 mm, 4 x (2 x 0.16 mm ²); quick connector, 12-pin/D-sub connector, female, 15-pin	1 m to 20 m	2 x 0.16 mm ²	EnDat22
				
735993-xx	APK Ø 4.5 mm, 4 x (2 x 0.16 mm ²); M12 quick connector, 12-pin/D-sub connector, male, 15-pin	1 m to 20 m	2 x 0.16 mm ²	EnDat22
				
735994-xx	APK Ø 4.5 mm, 4 x (2 x 0.16 mm ²); quick connector 12-pin/D-sub connector, female, 25-pin	1 m to 20 m	2 x 0.16 mm ²	EnDat22
				
738681-N5	APK Ø 8 mm, 3 x (2 x 0.16 mm ²) + 2 x 1.0 mm ² ; D-sub connector, male, 15-pin/ D-sub connector, male, 15-pin; PWM 2x/PWT 10x test cable	0.5 m	1.0 mm ²	11 µApp
				
738976-01	AGK ERN 1123 , single wires with heat-shrink tubing (without shield), 14 x 0.16 mm ² ; PCB connector, 15-pin/free cable end; collective package upon request	0.15 m	2 x 0.16 mm ²	TTL
				
739098-N5	APK Ø 8 mm, 4 x (2 x 0.16 mm ²) + 4 x 0.5 mm ² ; D-sub connector, male, 15-pin/ D-sub connector, male, 15-pin; PWM 2x/PWT 10x test cable	0.5 m	2 x 0.5 mm ²	1 V _{PP} TTL HTL
				
745454-xx	APK Ø 6 mm, 1 x (4 x 0.16 mm ²) + 4 x 0.34 mm ² ; M12 connector, female, 8-pin/D-sub connector, male, 15-pin	1 m to 30 m	0.34 mm ²	TS/TT
				
745796-xx	APK Ø 6 mm, 1 x (4 x 0.16 mm ²) + 4 x 0.34 mm ² ; M23 connector, female, 8-pin/M12 coupling, male, 9-pin	1 m to 50 m	2 x 0.34 mm ²	EnDat22
				
745894-xx	VBK Ø 8 mm, 2 x (2 x 0.24 mm ²) + 2 x (2 x 0.35 mm ²); M12 connector, female, 8-pin/M12 coupling, male, 8-pin	1 m to 50 m	2 x 0.35 mm ²	EnDat22 Fanuc.. Mit.. Pana.. YEC..
				
747400-xx	APK , spiral cable, 4 x 0.14 mm ² ; M12 connector, female, 8-pin/push-pull connector 6-pin	1 m to 3 m	0.14 mm ²	TS/TT
				
754232-xx	APK Ø 6 mm, 6 x (2 x 0.19 mm ²); M12 coupling, 14-pin/D-sub connector, female, 25-pin	1 m to 9 m	2 x 0.19 mm ²	1 V _{PP} TTL
				
754240-xx	APK PUR with braiding Ø 6.6 mm, 6 x (2 x 0.19 mm ²); M12 coupling, 14-pin/D-sub connector, female, 25-pin	1 m to 9 m	2 x 0.19 mm ²	1 V _{PP} TTL
				
754299-xx	APK Ø 10 mm, 6 x (2 x 0.19 mm ²); M12 coupling, 14-pin/D-sub connector, female, 25-pin	1 m to 9 m	2 x 0.19 mm ²	1 V _{PP} TTL
				



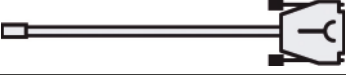



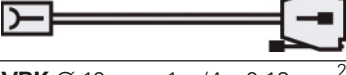
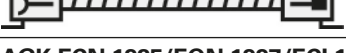



ID		Length	Ap	Application
758082-xx	APK Ø 8 mm, 4 x (2 x 0.16 mm ²) + 4 x 0.5 mm ² ; M23 connector, female, 12-pin/D-sub connector, female, 25-pin 	1 m to 50 m	2 x 0.5 mm ²	1 V _{PP} TTL HTL
770966-xx	APK Ø 4.5 mm, 4 x (2 x 0.16 mm ²); quick connector, 12-pin/"Mitsubishi" connector, male, 20-pin 	1 m to 20 m	2 x 0.16 mm ²	Mit..
770967-xx	APK Ø 4.5 mm, 4 x (2 x 0.16 mm ²); quick connector, 12-pin/"Fanuc" connector, female, 15-pin 	1 m to 20 m	2 x 0.16 mm ²	Fanuc..
770968-xx	APK Ø 4.5 mm, 4 x (2 x 0.16 mm ²); quick connector, 12-pin/"Mitsubishi" connector, female, 10-pin 	1 m to 20 m	2 x 0.16 mm ²	Mit..
801129-xx	APK Ø 3.7 mm, 4 x (2 x 0.09 mm ²); M12 connector, female, 8-pin/D-sub connector, male, 15-pin 	1 m to 6 m	2 x 0.09 mm ²	EnDat22 Fanuc.. Mit..
801140-xx	APK Ø 3.7 mm, 4 x (2 x 0.09 mm ²); M12, female, 8-pin angled/D-sub connector, male, 15-pin 	1 m to 6 m	2 x 0.09 mm ²	EnDat22
801142-xx	VBK Ø 3.7 mm, 4 x (2 x 0.09 mm ²); M12 connector, female, 8-pin/M12 coupling, male, 8-pin 	1 m to 6 m	2 x 0.09 mm ²	EnDat22
801149-xx	VBK Ø 3.7 mm, 4 x (2 x 0.09 mm ²); M12 connector, female, angled 8-pin/M12 coupling, male, 8-pin 	1 m to 6 m	2 x 0.09 mm ²	EnDat22
801285-xx	VBK Ø 6 mm, 6 x (2 x 0.19 mm ²); M12 connector, female, 12-pin 	1 m to 20 m	0.19 mm ²	TS/TT
804201-01	AGK EBI 1135 , TPE single wires with net sleeves (without shield), 8 x 0.16 ² ; PCB connector 15-pin/M12 flange socket, straight, male, 8-pin 	0.15 m	2 x 0.16 mm ²	EnDat22
805320-01	AGK ECI 1118 , TPE single wires with net sleeves (without shield), 6 x 0.16 ² ; PCB connector 15-pin/M12 flange socket, straight, male, 8-pin 	0.15 m	2 x 0.16 mm ²	EnDat22
805375-xx	APK Ø 6.8 mm, color green, 2 x (2 x 0.17 mm ²) + 1 x (2 x 0.24 mm ²); M12 encoder connector 14-pin/"Siemens" RJ45 connector 	1 m to 30 m	0.24 mm ²	DQ..
805452-xx	APK Ø 6.8 mm, color green, 2 x (2 x 0.17 mm ²) + 1 x (2 x 0.24 mm ²); M12 coupling, 14-pin/M12 coupling, male, 8-pin 	1 m to 20 m	0.24 mm ²	DQ..





ID		Length	A _p	Application
808976-xx	APK Ø 4.5 mm, 4 x (2 x 0.16 mm ²); D-sub connector, female, 15-pin/"Yaskawa" connector, female, 6-pin 	1 m to 6 m	2 x 0.16 mm ²	YEC..
816675-xx	APK Ø 10 mm, 2 x (2 x 0.17 mm ²) + 1 x (2 x 0.24 mm ²); M12 coupling, 14-pin/M12 coupling, male, 8-pin 	1 m to 20 m	0.24 mm ²	DQ..
822504-xx	VBK Ø 6.8 mm, color green, 2 x (2 x 0.17 mm ²) + 1 x (2 x 0.24 mm ²); M12 connector, female, 8-pin/M12 coupling, male, 8-pin 	1 m to 30 m	0.24 mm ²	DQ..
823924-xx	APK Ø 6 mm, 1 x (4 x 0.16 mm ²) + 4 x 0.34 mm ² ; M12 connector, female, 8-pin/D-sub connector, 3-row, male, 15-pin 	1 m to 20 m	2 x 0.34 mm ²	TS/TT
825855-03	AGK ECI 119 / EBI 135 , Ø 4.5 mm EPG (cable clamp mounted over crimp sleeve), 4 x (2 x 0.16 mm ²); PCB connector 15-pin/cable cut off 	0.3 m	2 x 0.16 mm ²	EnDat22
826269-01	VBK PVC Ø 6.2 mm, color gray, 5 x 0.34 mm ² ; D-sub connector, 3-row with metal housing, locking screws and integrated electronics, male, 15-pin/free cable end 	5 m	0.34 mm ²	TL
827607-xx	APK Ø 4.5 mm, 4 x (2 x 0.16 mm ²); quick connector, 12-pin/M23 coupling, male, 17-pin 	0.5 m to 20 m	2 x 0.16 mm ²	Fanuc.. Mit..
1034913-03	AGK ECI 1319/EQI 1331 Gen. 3/ECN 1325/EQN 1337 , Ø 3.7 mm EPG (with shield crimping Ø 6.1 mm), 1 x (4 x 0.06 mm ²) + 4 x 0.06 mm ² ; PCB connector, 12-pin/contact insert for HMC 6 hybrid connecting element, male, 6-pin 	0.3 m	2 x 0.06 mm ²	EnDat22
1034953-15	AGK ECN 1123/EQN 1135 , Ø 3.7 mm EPG, 1 x (4 x 0.06 mm ²) + 4 x 0.06 mm ² ; PCB connector, 15-pin/contact insert for HMC 6 hybrid connector, male, 6-pin 	0.15 m	0.06 mm ²	EnDat22
1035387-03	AGK ECI 1319/EQI 1331 Gen. 3/ECN 1325/EQN 1337 , Ø 3.7 mm EPG (with shield crimping Ø 6.1 mm), 1 x (4 x 0.06 mm ²) + 4 x 0.06 mm ² with TPE wires, 2 x 0.16 mm ² for temperature sensor; PCB connector, 16-pin/contact insert for HMC 6 hybrid connecting element, male, 6-pin 	0.3 m	0.06 mm ²	EnDat22
1035857-15	AGK ECN 1123/EQN 1135 , Ø 3.7 mm EPG, 1 x (4 x 0.06 mm ²) + 4 x 0.06 mm ² with TPE wires, 2 x 0.16 mm ² for temperature sensor; PCB connector, 15-pin/ contact insert for HMC 6 hybrid connector, male, 6-pin 	0.15 m	0.06 mm ²	EnDat22
1036361-xx	APK Ø 6 mm, 2 x (2 x 0.09 mm ²) + 2 x (2 x 0.16 mm ²); quick connector, 12-pin/M12 coupling, male, 8-pin 	1 m to 20 m	2 x 0.16 mm ²	EnDat22 Fanuc.. Mit.. Pana.. YEC..







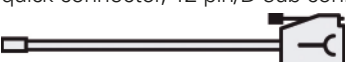
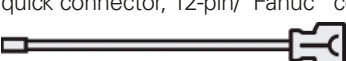
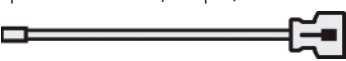

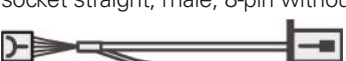
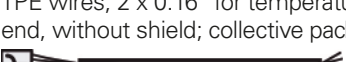
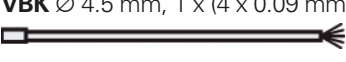
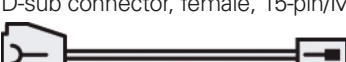
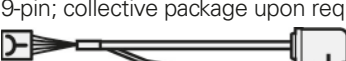

ID		Length	Ap	Application
1036372-xx	VBK Ø 6 mm, 2 x (2 x 0.09 mm ²) + 2 x (2 x 0.16 mm ²); M12 connector, female, 8-pin/M12 coupling, male, 8-pin 	1 m to 30 m	2 x 0.16 mm ²	EnDat22 Fanuc.. Mit.. Pana.. YEC.. TS/TT
1036380-xx	VBK Ø 8 mm, 2 x (2 x 0.24 mm ²) + 2 x (2 x 0.35 mm ²); M12 right-angle connector, female, 8-pin/M12 coupling, male, 8-pin 	1 m to 50 m	2 x 0.35 mm ²	EnDat22 Fanuc.. Mit.. Pana.. YEC..
1036386-xx	VBK Ø 6 mm, 2 x (2 x 0.09 mm ²) + 2 x (2 x 0.16 mm ²); M12 right-angle connector, female, angled 8-pin/M12 coupling, male, 8-pin 	1 m to 30 m	2 x 0.16 mm ²	EnDat22 Fanuc.. Mit.. Pana.. YEC..
1036521-xx	APK Ø 6 mm, 2 x (2 x 0.09 mm ²) + 2 x (2 x 0.16 mm ²); M12 connector, female, 8-pin/D-sub connector, female, 15-pin 	1 m to 50 m	2 x 0.16 mm ²	EnDat22
1036526-xx	APK Ø 6 mm, 2 x (2 x 0.09 mm ²) + 2 x (2 x 0.16 mm ²); M12 connector, female, 8-pin/D-sub connector, male, 15-pin 	1 m to 30 m	2 x 0.16 mm ²	EnDat22 Fanuc.. Mit.. Pana.. YEC..
1036537-xx	APK Ø 4.5 mm, 1 x (4 x 0.09 mm ²) + 4 x 0.16 mm ² ; M12 coupling, 14-pin/M12 coupling, male, 8-pin 	1 m to 20 m	2 x 0.16 mm ²	EnDat22 Fanuc.. Mit.. Pana.. YEC..
1036547-xx	APK Ø 6 mm, 2 x (2 x 0.09 mm ²) + 2 x (2 x 0.16 mm ²); M12 coupling, 14-pin/M12 coupling, male, 8-pin 	1 m to 20 m	2 x 0.16 mm ²	EnDat22 Fanuc.. Mit.. Pana.. YEC..
1036549-xx	APK Ø 4.5 mm, 1 x (4 x 0.09 mm ²) + 4 x 0.16 mm ² ; M12 coupling, 14-pin/M23 coupling, male, 17-pin 	1 m to 9 m	2 x 0.16 mm ²	EnDat22 Fanuc.. Mit.. Pana.. YEC..
1036555-xx	APK Ø 6 mm, 2 x (2 x 0.09 mm ²) + 2 x (2 x 0.16 mm ²); M12 coupling, 14-pin/M23 coupling, male, 17-pin 	1 m to 9 m	2 x 0.16 mm ²	EnDat22 Fanuc.. Mit.. Pana.. YEC..
1036724-xx	APK Ø 4.5 mm, 1 x (4 x 0.09 mm ²) + 4 x 0.16 mm ² ; M12 coupling, 14-pin/"Fanuc" connector, female, 15-pin 	1 m to 30 m	2 x 0.16 mm ²	Fanuc..
1036726-xx	APK Ø 6 mm, 2 x (2 x 0.09 mm ²) + 2 x (2 x 0.16 mm ²); M12 coupling, 14-pin/"Fanuc" connector, female, 15-pin 	1 m to 30 m	2 x 0.16 mm ²	Fanuc..
1036736-xx	APK Ø 4.5 mm, 1 x (4 x 0.09 mm ²) + 4 x 0.16 mm ² ; M12 coupling, 14-pin/"Mitsubishi" connector, male, 20-pin 	1 m to 30 m	2 x 0.16 mm ²	Mit..



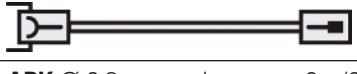

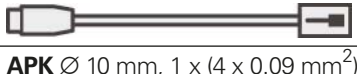







ID		Length	A _p	Application
1036737-xx	APK Ø 6 mm, 2 x (2 x 0.09 mm ²) + 2 x (2 x 0.16 mm ²); M12 coupling, 14-pin/"Mitsubishi" connector, male, 20-pin 	1 m to 30 m	2 x 0.16 mm ²	Mit..
1036775-xx	APK Ø 4.5 mm, 1 x (4 x 0.09 mm ²) + 4 x 0.16 mm ² ; M12 coupling, 14-pin/"Mitsubishi" connector, male, 10-pin 	1 m to 30 m	2 x 0.16 mm ²	Mit..
1036781-xx	APK Ø 6 mm, 2 x (2 x 0.09 mm ²) + 2 x (2 x 0.16 mm ²); M12 coupling, 14-pin/"Mitsubishi" connector, male, 10-pin 	1 m to 30 m	2 x 0.16 mm ²	Mit..
1036785-xx	APK Ø 4.5 mm, 1 x (4 x 0.09 mm ²) + 4 x 0.16 mm ² ; M12 coupling 14-pin/D-sub connector, female, 15-pin 	1 m to 30 m	2 x 0.16 mm ²	EnDat22
1036814-xx	APK Ø 6 mm, 2 x (2 x 0.09 mm ²) + 2 x (2 x 0.16 mm ²); M12 coupling 14-pin/D-sub connector, female, 15-pin 	1 m to 30 m	2 x 0.16 mm ²	EnDat22
1038743-xx	APK PUR Ø 6 mm, 6 x (2 x 0.19 mm ²); D-sub connector, female, 15 pin/MDR connector, male, 26-pin 	1 m, 3 m	2 x 0.19 mm ²	EIB 8791
1070793-xx	APK Ø 6 mm, 1 x (4 x 0.16 mm ²) + 4 x 0.34 mm ² ; M12 connector, female, 8-pin/D-sub connector, male, 9-pin; (TNC X13) 	1 m to 30 m	0.34 mm ²	TS/TT
1070794-xx	APK Ø 6 mm, 1 x (4 x 0.16 mm ²) + 4 x 0.34 mm ² ; M12 connector, female, 8-pin/D-sub connector, 3-row, male, 15-pin (PLB X113) 	1 m to 30 m	0.34 mm ²	TS/TT
1070795-xx	APK Ø 6 mm, 1 x (4 x 0.16 mm ²) + 4 x 0.34 mm ² ; M12 connector, female, 8-pin/D-sub connector, 3-row, male, 15-pin (PLB X112) 	1 m to 30 m	0.34 mm ²	TS/TT
1072523-xx	APK Ø 6 mm, 6 x (2 x 0.19 mm ²); quick connector, 12-pin/M23 mounted coupling, male, 17-pin with flange 	0.5 m to 3 m	2 x 0.19 mm ²	EnDat02
1072652-02	AGK ECI 119/ECI/EQI 11xx , Ø 3.7 mm EPG (cable clamp mounted over crimp sleeve), 1 x (4 x 0.06 mm ²) + 4 x 0.06 mm ² with TPE wires, 2 x 0.16 mm ² for temperature sensor; PCB connector, 15-pin/contact insert for HMC 6 hybrid connector, male, 6-pin 	0.2 m	0.06 mm ²	EnDat22
1073372-xx	VBK Ø 8 mm, 4 x (2 x 0.16 mm ²) + 4 x 0.5 mm ² ; D-sub connector, 3-row without locking screws, female, 15-pin/D-sub connector, male, 15-pin 3-row 	0.5 m to 20 m	0.5 mm ²	TS/TT



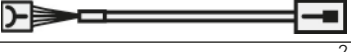





ID		Length	A _p	Application
1080050-xx	VBK Ø 6 mm, 2 x (2 x 0.09 mm ²) + 2 x (2 x 0.16 mm ²); quick connector, 12-pin 	1 m to 20 m	2 x 0.16 mm ²	EnDat22 Fanuc.. Mit.. Pana..
1080091-xx	VBK Ø 6 mm, 2 x (2 x 0.09 mm ²) + 2 x (2 x 0.16 mm ²); D-sub connector without locking screws, female, 15-pin/D-sub connector (pin) 15-pin; PWM 2x/PWT 10x test cable 	1 m to 15 m	2 x 0.16 mm ²	EnDat21 EnDat22
1083190-xx	VBK Ø 10 mm, 1 x (4 x 0.16 mm ²) + 4 x 0.34 mm ² ; M12 connector, female, 8-pin/partially with metal armor, end cut off 	1 m to 50 m	0.34 mm ²	TS/TT
1083369-xx	APK Ø 6 mm, 2 x (2 x 0.09 mm ²) + 2 x (2 x 0.16 mm ²); M12 coupling 14-pin/D-sub connector, female, 25-pin 	1 m to 30 m	2 x 0.16 mm ²	EnDat22
1085542-xx	VBK, suitable for vacuum; D-sub connector, female, 15-pin/D-sub connector, female, 15-pin 	0.5 m to 10 m	2 x 0.05 mm ²	1 V _{pp}
1093042-xx	APK Ø 6.8 mm, color green, 2 x (2 x 0.17 mm ²) + 1 x (2 x 0.24 mm ²); M12 connector, female, 8-pin/"Siemens" RJ45 connector 	1 m to 30 m	0.24 mm ²	DQ..
1094652-xx	APK Ø 6.8 mm, color green, 2 x (2 x 0.17 mm ²) + 1 x (2 x 0.24 mm ²); M12 connector, female, 8-pin/"Siemens" RJ45 connector IP67 (Yamaichi) 	1 m	0.24 mm ²	DQ..
1095709-xx	APK Ø 4.5 mm; (Renishaw TS on QUADRA-CHEK 3000); DIN coupling, female, 5-pin/D-sub connector, male, 15-pin 	0.5 m to 20 m	0.14 mm ²	QUADRA-CHEK
1095953-xx	APK Ø 4.5 mm; (Renishaw TS on ND 1xxx); DIN coupling, male, 5-pin/D-sub connector, male, 15-pin 	0.5 m to 20 m	0.14 mm ²	ND
1099975-xx	VBK Ø 10 mm, 1 x (4 x 0.16 mm ²) + 4 x 0.34 mm ² ; M12 connector, female, 8-pin/M23 connector, male, 7-pin 	1 m to 50 m	0.34 mm ²	TS/TT
1100199-N3	AGK ECN 1325/EQN 1337/ECI 1319/EQI 1331 TPE single wires with net sleeves (with shield crimping Ø 6.1 mm), 8 x 0.16 mm ² ; PCB connector, 12-pin/free cable end; collective package upon request 	0.3 m	2 x 0.16 mm ²	EnDat22
1108076-01	AGK ECN 1325/EQN 1337/ECI 1319/EQI 1331 Ø 3.7 mm EPG (with shield crimping Ø 6.1 mm), 1 x (4 x 0.06 mm ²) + 4 x 0.06 mm ² and TPE wires, 2 x 0.16 mm ² for temperature sensor; PCB connector, 16-pin/cable cut off; collective package upon request 	0.3 m	2 x 0.06 mm ²	EnDat22



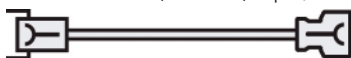



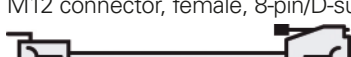
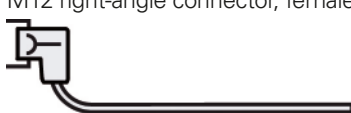
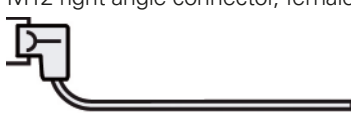
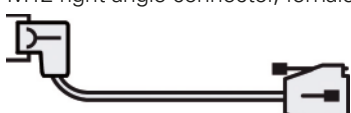

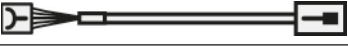

ID		Length	A _p	Application
1108078-01	AGK ECN 1123/EQN 1135 Ø 3.7 mm EPG (with shield crimping Ø 4.3 mm), 1 x (4 x 0.06 mm ²) + 4 x 0.06 mm ² and TPE wires, 2 x 0.16 mm ² for temperature sensor; PCB connector 15-pin/cable cut off; collective package upon request 	0.3 m	2 x 0.06 mm ²	EnDat22
1109993-xx	VBK Ø 10 mm, 6 x (2 x 0.19 mm ²); M12 connector, female, 12-pin/M12 coupling, male, 12-pin 	1 m to 20 m	0.19 mm ²	TS/TT
1116479-03	AGK ECI 119/EBI 135 Ø 3.7 mm EPG (cable clamp mounted over crimp sleeve), 1 x (4 x 0.06 mm ²) + 4 x 0.06 mm ² and TPE wires, 2 x 0.16 mm ² for temperature sensor; PCB connector 15-pin/cable cut off 	0.3 m	2 x 0.06 mm ²	EnDat22
1117280-01	AGK ECN 1325/EQN 1337/ECI 1319/EQI 1331 TPE single wires with net sleeves (with shield crimping Ø 6.1 mm), 8 x 0.16 mm ² and TPE wires, 2 x 0.16 mm ² for temperature sensor; PCB connector, 16-pin/M12 straight flange socket, male, 8-pin without shield; collective package upon request 	0.3 m	2 x 0.16 mm ²	EnDat22
1117412-01 1117412-03	AGK ECN 1123/EQN 1135 TPE single wires with net sleeves (with shield crimping Ø 4.3 mm), 8 x 0.16 mm ² and TPE wires, 2 x 0.16 mm ² for temperature sensor; PCB connector, 15-pin/M12 straight flange socket, male, 8-pin without shield; collective package upon request 	0.15 m 0.11 m	2 x 0.16 mm ²	EnDat22
1117540-xx	APK Ø 6.8 mm, color green, 2 x (2 x 0.17 mm ²) + 1 x (2 x 0.24 mm ²); M23 connector, female, 9-pin/"Siemens" RJ45 connector, IP20 	1 m to 30 m	0.24 mm ²	DQ..
1118858-xx	VBK Ø 3.7 mm, 1 x (4 x 0.06 mm ²) + 4 x 0.06 mm ² ; M12 connector, female, 8-pin/M12 coupling, male, 8-pin 	1 m to 6 m	2 x 0.06 mm ²	EnDat22 Fanuc.. Mit.. Pana.. YEC..
1118863-xx	VBK Ø 3.7 mm, 1 x (4 x 0.06 mm ²) + 4 x 0.06 mm ² ; M12 right-angle connector, female, , 8-pin/M12 coupling, male, 8-pin 	1 m to 6 m	2 x 0.06 mm ²	EnDat22 Fanuc.. Mit.. Pana.. YEC..
1118865-xx	APK Ø 3.7 mm, 1 x (4 x 0.06 mm ²) + 4 x 0.06 mm ² ; M12 connector, female, 8-pin/D-sub connector, male, 15-pin 	1 m to 6 m	2 x 0.06 mm ²	EnDat22 Fanuc.. Mit.. Pana.. YEC..
1118867-xx	APK Ø 3.7 mm, 1 x (4 x 0.06 mm ²) + 4 x 0.06 mm ² ; M12 connector, female, 8-pin, right-angle/D-sub connector, male, 15-pin 	1 m to 6 m	2 x 0.06 mm ²	EnDat22 Fanuc.. Mit.. Pana.. YEC..
1118892-02	AGK ERN 1387 PUR Ø 4.5 mm, 16 x 0.057 mm ² ; PCB connector with strain relief 14-pin/D-sub connector, male, 15-pin incl. 3 adapter connectors, 14-pin; PWM 2x test cable 	2 m	2 x 0.057 mm ²	1 V _{PP} + Z1



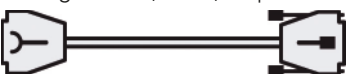

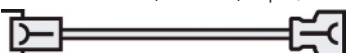

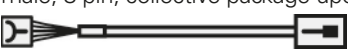
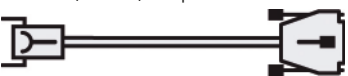
ID		Length	Ap	Application
1119209-xx	APK Ø 4.5 mm, 1 x (4 x 0.09 mm ²) + 4 x 0.16 mm ² ; quick connector, 12-pin/M23 coupling, male, 17-pin 	0.5 m to 9 m	2 x 0.16 mm ²	Fanuc.. Mit..
1119352-xx	APK Ø 4.5 mm, 1 x (4 x 0.09 mm ²) + 4 x 0.16 mm ² ; M12 quick connector, 12-pin/D-sub connector, male, 15-pin 	1 m to 30 m	2 x 0.16 mm ²	EnDat22
1119394-xx	APK Ø 4.5 mm, 1 x (4 x 0.09 mm ²) + 4 x 0.16 mm ² ; quick connector, 12-pin/D-sub connector, female, 15-pin 	1 m to 30 m	2 x 0.16 mm ²	EnDat22
1119910-xx	APK Ø 4.5 mm, 1 x (4 x 0.09 mm ²) + 4 x 0.16 mm ² ; quick connector, 12-pin/D-sub connector, female, 25-pin 	1 m to 30 m	2 x 0.16 mm ²	EnDat22
1119918-xx	APK Ø 4.5 mm, 1 x (4 x 0.09 mm ²) + 4 x 0.16 mm ² ; quick connector, 12-pin/"Fanuc" connector, female, 15-pin 	1 m to 30 m	2 x 0.16 mm ²	Fanuc..
1119920-xx	APK Ø 4.5 mm, 1 x (4 x 0.09 mm ²) + 4 x 0.16 mm ² ; quick connector, 12-pin/"Mitsubishi" connector, male, 20-pin 	1 m to 30 m	2 x 0.16 mm ²	Mit..
1119925-xx	APK Ø 4.5 mm, 1 x (4 x 0.09 mm ²) + 4 x 0.16 mm ² ; quick connector, 12-pin/"Mitsubishi" connector, female, 10-pin 	1 m to 30 m	2 x 0.16 mm ²	Mit..
1119952-15	AGK ECI 1119/EQI 1131 TPE single wires with net sleeves, 8 x 0.16 ² and TPE wires, 2 x 0.16 ² for temperature sensor; PCB connector 15-pin/M12 flange socket straight, male, 8-pin without shield; collective package upon request 	0.15 m	2 x 0.16 mm ²	EnDat22
1119958-15	AGK ECI 1119/EQI 1131 TPE single wires with net sleeves, 8 x 0.16 ² and TPE wires, 2 x 0.16 ² for temperature sensor; PCB connector 15-pin; free cable end, without shield; collective package upon request 	0.15 m	2 x 0.16 mm ²	EnDat22
1120664-xx	VBK Ø 4.5 mm, 1 x (4 x 0.09 mm ²) + 4 x 0.16 mm ² ; quick connector, 12-pin 	1 m to 20 m	2 x 0.16 mm ²	EnDat22 Fanuc.. Mit.. Pana.. YEC..
1120686-xx	APK Ø 6 mm, 2 x (2 x 0.09 mm ²) + 2 x (2 x 0.16 mm ²); D-sub connector, female, 15-pin/M12 coupling, male, 8-pin 	1 m to 30 m	2 x 0.16 mm ²	EnDat22 Fanuc.. Mit.. Pana.. YEC..
1120940-30	AGK ECI 4010/EBI 4010 Ø 3.7 mm EPG (with shield crimping Ø 4.3 mm), 1 x (4 x 0.06 mm ²) + 4 x 0.06 mm ² and TPE wires, 2 x 0.16 mm ² for temperature sensor; PCB connector, 15-pin/M23 SpeedTEC right-angle flange socket, male, 9-pin; collective package upon request 	0.3 m	2 x 0.06 mm ²	EnDat22

ID		Length	A _p	Application
1120945-15 1120945-30	AGK ECN 1324S/EQN 1336S Ø 3.7 mm EPG (with shield crimping Ø 6.1 mm), 2 x (2 x 0.06 mm ²) + 4 x 0.06 mm ² and TPE wires, 2 x 0.16 mm ² for temperature sensor; PCB connector, 16-pin/M23 SpeedTEC right-angle flange socket, male, 9-pin; collective package upon request 	0.15 m 0.3 m	2 x 0.06 mm ²	DQ..
1120947-03	AGK ECI 119/EBI 135 Ø 3.7 mm EPG (cable clamp mounted over crimp sleeve), 1 x (4 x 0.06 mm ²) + 4 x 0.06 mm ² and TPE wires, 2 x 0.16 mm ² for temperature sensor; PCB connector, 15-pin/M23 SpeedTEC right-angle flange socket, male, 9-pin 	0.3 m	2 x 0.06 mm ²	EnDat22
1120948-01	AGK ECN 1325/EQN 1337/ECI 1319/EQI 1331 Ø 3.7 mm EPG (with shield crimping Ø 6,1 mm) 1 x (4 x 0.06 mm ²) + 4 x 0.06 mm ² and TPE wires 2 x 0.16 mm ² for temperature sensor; PCB connector, 16-pin/M23 SpeedTEC right-angle flange socket, male, 9-pin; collective package upon request 	0.3 m	2 x 0.06 mm ²	EnDat22
1121041-03	AGK ECI 4010/EBI 4010 Ø 3.7 mm EPG (with shield crimping Ø 4.3 mm), 1 x (4 x 0.06 mm ²) + 4 x 0.06 mm ² ; PCB connector, 15-pin/M23 SpeedTEC right-angle flange socket, male, 9-pin; collective package upon request 	0.3 m	2 x 0.06 mm ²	EnDat22
1121536-xx	APK Ø 6.8 mm, color green, 2 x (2 x 0.17 mm ²) + 1 x (2 x 0.24 mm ²); M23 SpeedTEC connector, female, 9-pin/M12 coupling, male, 8-pin 	1 m to 30 m	0.24 mm ²	DQ..
1121546-xx	APK Ø 6.8 mm, color green, 2 x (2 x 0.17 mm ²) + 1 x (2 x 0.24 mm ²); M23 SpeedTEC connector, female, 9-pin/"Siemens" RJ45 connector, IP20 	1 m to 30 m	0.24 mm ²	DQ..
1121591-xx	APK PUR Ø 6.8 mm, color green, 2 x (2 x 0.17 mm ²) + 1 x (2 x 0.24 mm ²); Ethernet RJ45 connector, IP67 with metal housing, male, 6-pin/M12 coupling, male, 8-pin 	20 m	0.24 mm ²	DQ..
1122879-xx	APK Ø 10 mm, 1 x (4 x 0.09 mm ²) + 4 x 0.16 mm ² ; M12 coupling, 14-pin/M12 coupling, male, 8-pin 	1 m to 20 m	2 x 0.16 mm ²	EnDat22 Fanuc.. Mit.. Pana.. YEC..
1123096-xx	APK Ø 10 mm, 1 x (4 x 0.09 mm ²) + 4 x 0.16 mm ² ; M12 coupling, 14-pin/D-sub connector, male, 15-pin 	1 m to 30 m	2 x 0.16 mm ²	EnDat22 Pana..
1123108-xx	APK Ø 10 mm, 1 x (4 x 0.09 mm ²) + 4 x 0.16 mm ² ; M12 coupling 14-pin/D-sub connector, female, 15-pin 	1 m to 30 m	2 x 0.16 mm ²	EnDat22

ID		Length	Ap	Application
1125403-N3	AGK ECI 4090 S Ø 3.7 mm EPG (with shield crimping Ø 4.3 mm), 2 x (2 x 0.06 mm ²) + 4 x 0.06 mm ² and TPE wires, 2 x 0.16 mm ² for temperature sensor; PCB connector, 15-pin/M23 SpeedTEC right-angle flange socket, male, 9-pin; collective package upon request 	0.3 m	2 x 0.06 mm ²	DQ..
1125408-N3	AGK ECI 4090S Ø 3.7 mm EPG (with shield crimping Ø 4.3 mm), 2 x (2 x 0.06 mm ²) + 4 x 0.06 mm ² ; PCB connector, 15-pin/M23 SpeedTEC right-angle flange socket, male, 9-pin; collective package upon request 	0.3 m	2 x 0.06 mm ²	DQ..
1126031-xx	APK Ø 10 mm, 1 x (4 x 0.09 mm ²) + 4 x 0.16 mm ² ; M12 coupling, 14-pin/"Fanuc" connector, female, 15-pin 	1 m to 30 m	2 x 0.16 mm ²	Fanuc..
1126035-xx	APK Ø 10 mm, 1 x (4 x 0.09 mm ²) + 4 x 0.16 mm ² ; M12 coupling, 14-pin/M23 coupling, male, 17-pin 	1 m to 9 m	2 x 0.16 mm ²	EnDat22 Fanuc.. Mit.. Pana..
1127794-xx	APK Ø 10 mm, 1 x (4 x 0.09 mm ²) + 4 x 0.16 mm ² ; M12 coupling, 14-pin/"Mitsubishi" connector, male, 20-pin 	1 m to 30 m	2 x 0.16 mm ²	Mit..
1127827-xx	APK Ø 10 mm, 1 x (4 x 0.09 mm ²) + 4 x 0.16 mm ² ; M12 coupling, 14-pin/"Mitsubishi" connector, male, 10-pin 	1 m to 30 m	2 x 0.16 mm ²	Mit..
1129083-xx	AGK MRP 2010 Ø 3.7 mm (with shield crimping Ø 3.7 mm), 1 x (4 x 0.06 mm ²) + 4 x 0.06 mm ² ; PCB connector, 12-pin/M12 coupling, male, 8-pin 	0.3 m 6 m	2 x 0.06 mm ²	EnDat22
1129415-xx	VBK Ø 10 mm, 2 x (2 x 0.09 mm ²) + 2 x (2 x 0.16 mm ²); M12 connector, female, 8-pin/M12 coupling, male, 8-pin 	1 m to 30 m	2 x 0.16 mm ²	TS/TT
1129574-xx	VBK Ø 10 mm, 2 x (2 x 0.09 mm ²) + 2 x (2 x 0.16 mm ²); M12 connector, female, 8-pin/partially with metal armor, end cut off 	1 m to 30 m	2 x 0.16 mm ²	TS/TT
1129581-xx	VBK Ø 6 mm, 2 x (2 x 0.09 mm ²) + 2 x (2 x 0.16 mm ²); M12 connector, female, 8-pin right-/free cable end, cut off 	1 m to 30 m	2 x 0.16 mm ²	EnDat22 Fanuc.. Mit.. Pana.. YEC..
1129591-xx	VBK Ø 8 mm, 2 x (2 x 0.24 mm ²) + 2 x (2 x 0.35 mm ²); M12 connector, female, 8-pin/free cable end, cut off 	1 m to 50 m	2 x 0.35 mm ²	EnDat22 Fanuc.. Mit.. Pana.. YEC..
1129753-xx	APK Ø 8 mm, 2 x (2 x 0.24 mm ²) + 2 x (2 x 0.35 mm ²); M12 connector, female, 8-pin/D-sub connector, male, 15-pin 	1 m to 50 m	2 x 0.35 mm ²	EnDat22 Fanuc.. Mit.. Pana.. YEC..

ID		Length	A _p	Application
1130829-xx	APK Ø 6 mm, 2 x (2 x 0.09 mm ²) + 2 x (2 x 0.16 mm ²); M12 connector, female, 8-pin/M23 coupling, male, 17-pin 	1 m to 9 m	2 x 0.16 mm ²	EnDat22 Fanuc.. Mit.. Pana.. YEC..
1130952-xx	APK Ø 6 mm, 2 x (2 x 0.09 mm ²) + 2 x (2 x 0.16 mm ²); M12 connector, female, 8-pin/"Fanuc" connector, female, 15-pin 	1 m to 30 m	2 x 0.16 mm ²	Fanuc..
1130978-xx	APK Ø 8 mm, 2 x (2 x 0.24 mm ²) + 2 x (2 x 0.35 mm ²); M12 connector, female, 8-pin/"Fanuc" connector, female, 15-pin 	1 m to 50 m	2 x 0.35 mm ²	Fanuc..
1130994-xx	APK Ø 8 mm, 2 x (2 x 0.24 mm ²) + 2 x (2 x 0.35 mm ²); M12 connector, female, 8-pin/D-sub connector, female, 15-pin 	1 m to 50 m	2 x 0.35 mm ²	EnDat22
1132594-xx	APK Ø 6 mm, 2 x (2 x 0.09 mm ²) + 2 x (2 x 0.16 mm ²); M12 connector, female, 8-pin/"Mitsubishi" connector, male, 20-pin 	1 m to 30 m	2 x 0.16 mm ²	Mit..
1132621-xx	APK Ø 6 mm, 2 x (2 x 0.09 mm ²) + 2 x (2 x 0.16 mm ²); M12 connector, female, 8-pin/"Mitsubishi" connector, male, 10-pin 	1 m to 30 m	2 x 0.16 mm ²	Mit..
1133104-xx	APK Ø 6 mm, 2 x (2 x 0.09 mm ²) + 2 x (2 x 0.16 mm ²); M12 connector, female, 8-pin/D-sub connector, female, 25-pin 	1 m to 30 m	2 x 0.16 mm ²	EnDat22
1133119-xx	APK Ø 8 mm, 2 x (2 x 0.24 mm ²) + 2 x (2 x 0.35 mm ²); M12 connector, female, 8-pin/D-sub connector, female, 25-pin 	1 m to 50 m	2 x 0.35 mm ²	EnDat22
1133799-xx	VBK Ø 6 mm, 2 x (2 x 0.09 mm ²) + 2 x (2 x 0.16 mm ²); M12 right-angle connector, female, 8-pin/free cable end, cut off 	1 m to 30 m	2 x 0.16 mm ²	EnDat22 Fanuc.. Mit.. Pana.. YEC..
1133832-xx	VBK Ø 8 mm, 2 x (2 x 0.24 mm ²) + 2 x (2 x 0.35 mm ²); M12 right-angle connector, female, 8-pin/free cable end, cut off 	1 m to 50 m	2 x 0.35 mm ²	EnDat22 Fanuc.. Mit.. Pana.. YEC..
1133855-xx	APK Ø 6 mm, 2 x (2 x 0.09 mm ²) + 2 x (2 x 0.16 mm ²); M12 right-angle connector, female, 8-pin/D-sub connector, male, 15-pin 	1 m to 10 m	2 x 0.16 mm ²	EnDat22 Fanuc.. Mit.. Pana.. YEC..
1136863-xx	APK Ø 6 mm, 2 x (2 x 0.09 mm ²) + 2 x (2 x 0.16 mm ²); M23 connector, female, 9-pin/M12 coupling, male, 8-pin 	1 m to 9 m	2 x 0.16 mm ²	EnDat22

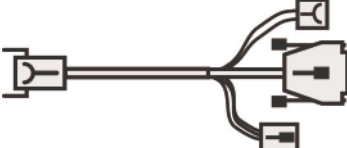
ID		Length	Ap	Application
1136874-xx	APK Ø 8 mm, 2 x (2 x 0.24 mm ²) + 2 x (2 x 0.35 mm ²); M23 connector, female, 9-pin/M23 coupling, male, 8-pin 	1 m to 9 m	2 x 0.35 mm ²	EnDat22
1137151-xx	AGK MRP 5010/MRP 8010 Ø 3.7 mm (with shield crimping Ø 3.7 mm), 1 x (4 x 0.06 mm ²) + 4 x 0.06 mm ² ; PCB connector, 15-pin/M12 coupling, male, 8-pin 	0.3 m to 6 m	2 x 0.06 mm ²	EnDat22
1139183-xx	VBK PUR Ø 6 mm, 2 x (2 x 0.09 mm ²) + 2 x (2 x 0.16 mm ²); D-sub connector, 2-row with locking screws, female, 15-pin/D-sub connector, male, 15-pin; 	1 m to 30 m	2 x 0.16 mm ²	EnDat22
1143830-30	AGK ECN 1325/EQN 1337/ECI 1319/EQJ 1331 TPE single wires with net sleeves, 8 x 0.16 ² and TPE wires, 2 x 0.16 ² for temperature sensor; PCB connector 16-pin/free cable end, without shield; collective package upon request 	0.3 m	2 x 0.16 mm ²	EnDat22
1158342-xx	APK Ø 4.5 mm, 1 x (4 x 0.09 mm ²) + 4 x 0.16 mm ² ; M12 coupling, 14-pin/D-sub connector, male, 15-pin 	1 m to 30 m	2 x 0.16 mm ²	EnDat22 Pana..
1159446-xx	APK Ø6 mm; encoder adapter cable for direct connection to AccurET position controller; D-sub connector 2-row, female, 15-pin/D-sub connector 3-row with locking screws, male, 15-pin 	1 m to 20 m	2 x 0.19 mm ²	1 V _{PP}
1160261-xx	APK Ø 6 mm, 2 x (2 x 0.09 mm ²) + 2 x (2 x 0.16 mm ²); M12 coupling, 14-pin/MUF connector, female, 10-pin 	1 m to 30 m	2 x 0.16 mm ²	Pana..
1160268-xx	APK Ø 6 mm, 2 x (2 x 0.09 mm ²) + 2 x (2 x 0.16 mm ²); M12 connector, female, 8-pin/MUF connector, female, 10-pin 	1 m to 30 m	2 x 0.16 mm ²	Pana..
1160480-xx	AGK MRP 2080 Ø 3.7 mm (with shield crimping Ø 3.7 mm), 6 x (6 x 0.05 mm ²); PCB connector, 14-pin/D-sub connector, male, 15-pin 	0.3 m to 6 m	2 x 0.05 mm ²	1 V _{PP}
1160559-01	AGK ECI 4090S Ø 3.7 mm EPG (with shield crimping Ø 4.3 mm), 2 x (2 x 0.06 mm ²) + 4 x 0.06 mm ² ; PCB connector, 15-pin/M12 coupling, male, 8-pin; collective package upon request 	1 m	2 x 0.06 mm ²	DQ..
1165032-xx	APK Ø6 mm; encoder adapter cable for direct connection to AccurET position controller; M12 connector, female, 8-pin/D-sub connector, 3-row with locking screws, male, 15-pin 	1 m to 20 m	2 x 0.14 mm ²	EnDat22
1173166-xx	APK PUR Ø 6 mm, 2 x (2 x 0.09 mm ²) + 2 x (2 x 0.16 mm ²); M23 connector, female, 9-pin/D-sub connector, 2-row with locking screws, male, 15-pin 	9 m	2 x 0.16 mm ²	EnDat22
1180354-03	VBK , spiral cable, 4 x 0.14; M12 connector, female, 8-pin/free cable end 	3 m	0.14 mm ²	TS/TT

ID		Length	A _p	Application
1181373-15 1181373-30	AGK ECN 1324S/EQN 1336S Ø 3.7 mm; EPG, (with shield crimping Ø 6.1 mm), 2 x (2 x 0.06 mm ²) + 4x 0.06 mm ² and TPE wires, 2 x 0.16 mm ² for temperature sensor; PCB connector 16-pi/M12 flange socket, male, 8-pin; collective package upon request 	0.15 m 0.3 m	0.06 mm ²	DQ..
1183206-xx	VBK Ø 6 mm, 6 x (2 x 0.19 mm ²); D-sub connector, 3-row, female, 15-pin/D-sub connector 3-row, male, 15-pin 	1 m to 10 m	0.19 mm ²	TS/TT
1184715-xx	AGK Ø 4.5 mm, 2 x 0.38 mm ² ; base for TS 150 with axial cable outlet/ socket connector with screw terminals, 3-pin 	10 m	–	TS/TT
1188098-xx	VBK PUR Ø 13.6 mm, color orange, (2 x (2 x 0.09 mm ²) + 2 x 0.24 mm ²) + (2 x 1.0 mm ² + 1 x 1.5 mm ²) + (3 x 1.5 mm ²); 1.5 mm ² power leads with M23 SpeedTEC hybrid connector for HMC 6, cable cut off 	10 m 25 m 50 m	0.24 mm ²	EnDat22
1188099-xx	VBK PUR Ø 16.6 mm, color orange, (2 x (2 x 0.09 mm ²) + 2 x 0.24 mm ²) + (2 x 1.0 mm ² + 1 x 4 mm ²) + (3 x 4 mm ²); 4 mm ² power leads with M23 SpeedTEC hybrid connector for HMC 6, cable cut off 	10 m 25 m 50 m	0.24 mm ²	EnDat22
1189174-01	APK PUR Ø 13.6 mm, color orange, (2 x (2 x 0.09 mm ²) + 2 x 0.24 mm ²) + (2 x 1.0 mm ² + 1 x 1.5 mm ²) + (3 x 1.5 mm ²); 1.5 mm ² power leads with M23 SpeedTEC hybrid connector for HMC 6 and D-sub connector, male, 15-pin, test cable for PWM 2x 	1 m	0.24 mm ²	EnDat22
1213408-xx	AGK Ø 4.5 mm, 2 x 0.38 mm ² ; base for TS 150 with radial cable outlet/ socket connector with screw terminals, 3-pin 	10 m	–	TS/TT
1217425-xx	VBK Ø 6 mm, 6 x (2 x 0.19 mm ²); D-cub connector, 3-row, female, 15-pin/free cable end, cut off 	1 m to 10 m	0.19 mm ²	TS/TT

Signal cable

Signal cables are available in fixed lengths for various interfaces. These lengths have fixed links to a certain variant. The type of package also depends on the length. In the *Pin layouts* section you will find the assignment of wire colors.







ID	Cable type	Cable design	AP	Application
816317-xx	PUR Ø 8 mm	$4 \times (2 \times 0.14 \text{ mm}^2) + 4 \times 0.5 \text{ mm}^2$	$2 \times 0.5 \text{ mm}^2$	1 V _{PP} TTL HTL
816322-xx	PUR Ø 8 mm	$(4 \times 0.14 \text{ mm}^2) + 4 \times (2 \times 0.14 \text{ mm}^2) + 4 \times 0.5 \text{ mm}^2$	$2 \times 0.5 \text{ mm}^2$	EnDat01 EnDat02
816323-xx	PUR Ø 6 mm	$6 \times (2 \times 0.19 \text{ mm}^2)$	$2 \times 0.19 \text{ mm}^2$	1 V _{PP} TTL HTL
816327-xx	PUR Ø 8 mm	$1 \times (4 \times 0.16 \text{ mm}^2) + (4 \times 1.0 \text{ mm}^2)$	$2 \times 1.0 \text{ mm}^2$	Fanuc.. Mit..
1150200-xx	PUR Ø 6 mm	$2 \times (2 \times 0.09 \text{ mm}^2) + 2 \times (2 \times 0.16 \text{ mm}^2)$	$2 \times 0.16 \text{ mm}^2$	EnDat22 EnDat21 Fanuc.. Mit.. Pana.. YEC..

Variant	Packaging	Length
-01	Bundle in bag	10 m
-02	Bundle in bag	20 m
-04	Bundle on cardboard core	100 m
-07	Plastic reel	1000 m

Connector

M8, M12, M23 connecting elements

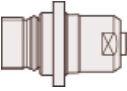
Loose connecting elements in solder or crimp versions are available for the connection types M8, M12 and M23. Various D-sub, MIL and HMC 6 models are also available as special accessories.

Model	Number of pins	Type	Contact	Type of contact	
M8 	3-pin	Connector	Male	Solder	
			Female	Solder	
M12 	8-pin	Connector	Female	Solder	
		Coupling	Male	Solder	
	8-pin	Adapter connectors	Wall duct 1:1		
M23 Connector  Coupling  Mounted coupling with flange  Mounted coupling with central fastening  Flange socket 	7-pin	Connector	Male	Solder	
			Female	Solder	
		Coupling	Female	Solder	
		9-pin	Connector	Male	Solder
				Female	Solder
			Coupling	Male	Solder
			Female	Solder	
	Mounted coupling with flange		Male	Solder	
			Female	Solder	
	12-pin	Flange socket	Male	Solder	
			Female	Solder	
		Connector	Male	Solder	
			Female	Solder	
		Built-in connector	Female	Solder	
		Coupling	Male	Solder	
			Female	Solder	
		Mounted coupling with flange	Male	Solder	
			Male	Crimp	
			Female	Solder	
		Mounted coupling with central fastening	Male	Solder	
		17-pin	Flange socket	Male	Solder
	Female			Solder	
	Adapter connectors		Connector (female) to connector (male)		
	21-pin	Connector	Male	Crimp	
			Female	Crimp	
		Built-in connector	Female	Crimp	
Coupling		Male	Crimp		
			Crimp (1 mm ²)		
Mounted coupling with flange		Male	Crimp		
		Female	Crimp		
Mounted coupling with central fastening		Male	Crimp		
Flange socket		Male	Crimp		
	Female	Crimp			
Assembly tool					
21-pin	Connector	Male	Crimp		
		Female	Crimp		
	Coupling	Male	Crimp		
	Flange socket	Male	Crimp		
Female		Crimp			

ID for listed cable diameters					
xx	3.7 mm	4.5 mm (*3.5 mm to 5 mm)	6.00 mm	8.00 mm	(A) = 4.5 to 8.5 mm (B) = 6 to 10 mm
		1071953-01 *			
		1071955-01 *			
		582180-01			
		582180-02			
1142270-01					
			291697-14	291697-15	
				291697-13	
			291698-09		
		291697-02	291697-03	291697-04	
			291697-16	291697-01	
			291698-42	291698-24	
			291698-11	291698-01	
			291698-16		
			291698-15	291698-06	
315892-05					
315892-06					
		291697-06	291697-07	291697-08	
	291697-46	291697-47	291697-48	291697-49	
			291697-17	291697-05	
			291697-42		
	291698-38	291698-14	291698-03	291698-04	
			291698-12	291698-02	
		291698-23	291698-08	291698-31	
	291698-52	291698-53	291698-54	291698-55	
			291698-17	291698-07	
					741045-04 (A) 741045-01 (B)
315892-07					
315892-08					
373848-01					
				291697-27	
				291697-26	
			291697-36	291697-40	
		291698-49	291698-50	291698-27	
		291698-25	291698-26		
		291698-43	291698-41	291698-29	
				291698-35	
					741045-05 (A) 741045-02 (B)
315892-09					
315892-10					
236148-02					
				291697-31	
				291697-30	
				291698-30	
315892-11					
315892-12					

Sub-D, HMC 6 connecting elements

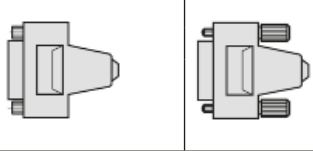
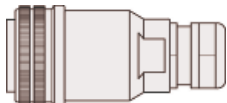
Model	Number of pins	Type	Contact	Type of contact
	15-pin	Connector	Female	Solder
	9-pin	Connector for external inputs on the IK 220	Female	Solder
	15-pin	Connector	Female	Solder
	25-pin	Connector for switching inputs/outputs, ND 200	Male	Solder
	17-pin	Connector	Female	Solder
			Female	Solder

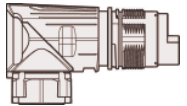
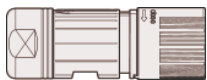
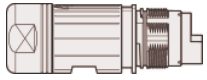
Model	Number of poles	Type	Contact	Type of contact
M23 Flange socket SpeedTec 	7-pin	<i>Service pack</i> Flange socket for HMC 6 Flange with bolt circle Ø 28 mm incl. contacts, contact insert and dust protection cap Without communication element (see AGK) 2.5 mm ² power leads	Male	Crimp
		<i>Service pack</i> Flange socket for HMC 6 Flange with bolt circle Ø 32 mm incl. contacts, contact insert and dust protection cap Without communication element (see AGK) 2.5 mm ² power leads	Male	Crimp
Connector SpeedTec 	7-pin + 6-pin	<i>Service pack</i> Connector for HMC 6 incl. contacts, contact insert and communication element 1.5 mm ² power leads	Female	Crimp
		<i>Service pack</i> Connector for HMC 6 incl. contacts, contact insert and communication element 4.0 mm ² power leads	Female	Crimp
Coupling SpeedTec 	7-pin + 6-pin	<i>Service pack</i> Coupling for HMC 6 incl. contacts, contact insert and communication element 1.5 mm ² power leads	Male	Crimp
		<i>Service pack</i> Coupling for HMC 6 incl. contacts, contact insert and communication element 4.0 mm ² power leads	Male	Crimp

Only for provision of samples and deliveries for servicing purposes.

For larger purchase quantities, please refer to the sources of supply in the *HMC 6* Product Information document.

SpeedTEC is a registered trademark of TE Connectivity Industrial GmbH.









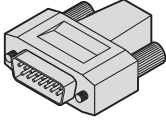
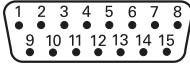

ID for listed cable diameters					
xx	3.7 mm	4.5 mm (*3.5 mm to 5 mm)	6.00 mm	8.00 mm	(A) = 4.5 to 8.5 mm (B) = 6 to 10 mm
315650-14					
315650-02					
315650-04					
315650-05					
315650-06					
				1094831-01	

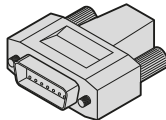
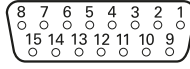
ID for listed cable diameters			
xx	13.6 mm Cable clamping range: Ø 9.5 mm to 14.5 mm	16.6 mm Cable clamping range: Ø 14 mm to 17 mm	
1043027-01			
1043027-02			
	1075255-01		
		1075255-02	
	1084549-01		
		1084549-02	

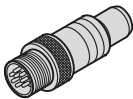
Pin layouts

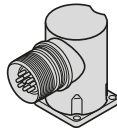
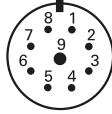
EnDat22

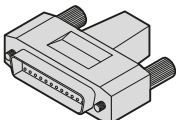
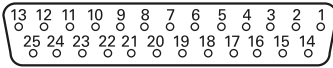
Pin layout

① D-sub connector, 15-pin   					② D-sub connector, 15-pin   				
③ M12 coupling, 8-pin   					④ M23 flange socket, 9-pin   				
⑤ D-sub connector, 25-pin   									
	Voltage supply				Serial data				
①	4	12	2	10	5	13	8	15	
②	1	9	2	11	5	8	14	15	
③	8	2	5	1	3	4	7	6	
④	3	7	4	8	5	6	1	2	
⑤	1	14	2	16	15	23	10	12	
	Brown/Green	Blue	White/Green	White	Gray	Pink	Violet	Yellow	
	U_P	Sensor U _P	0V	Sensor 0V	DATA	DATA	CLOCK	CLOCK	

Cable shield connected to housing; **U_P** = Power supply voltage

Sensor: The sensor line is connected in the encoder with the corresponding power line.

Vacant pins or wires must not be used!

① 15-pin

ND 280
ND 287
EIB 74x
PWM 2x
PWT 10x
MSE 1000

② 15-pin

TNC
iTNC
(SMC 40)

③ 8-pin

M12

④ 9-pin





M23

⑤ 25-pin

TNC
iTNC

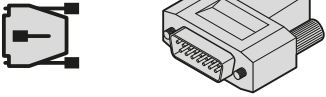
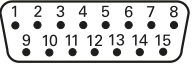
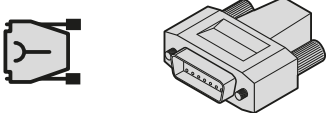
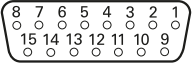
EnDat 2.1 (EnDat01/EnDat02)

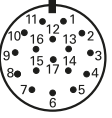
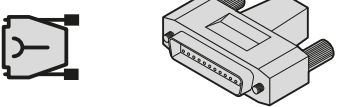
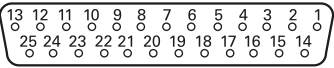
Pin layout

① D-sub connector, 15-pin  					② D-sub connector, 15-pin  								
③ M23 coupling, 17-pin  													
④ D-sub connector, 25-pin  													
	Voltage supply					Incremental signals				Serial data			
①	4	12	2	10	6	1	9	3	11	5	13	8	15
②	1	9	2	11	13	3	4	6	7	5	8	14	15
③	7	1	10	4	11 ¹⁾	15	16	12	13	14	17	8	9
④	1	14	2	16	/	3	4	6	7	15	23	10	12
	Brown/ Green	Blue	White/ Green	White	/	Green/ Black	Yellow/ Black	Blue/ Black	Red/ Black	Gray	Pink	Violet	Yellow
	U_P	Sensor U _P	0V	Sensor 0V	Internal shield	A+	A-	B+	B-	DATA	DATA	CLOCK	CLOCK

Cable shield connected to housing; **U_P** = Power supply voltage

Sensor: The sensor line is connected in the encoder with the corresponding power line.

Vacant pins or wires must not be used!

¹⁾ Only ID 309778-xx, ID 323897-xx, ID 324544-xx, ID 332115-xx, ID 509667-xx

²⁾ Motors from HEIDENHAIN for connection to a TNC have a different layout. For suitable cables, refer to the *Cable overviews* in the TNC brochure *Information for the Machine Tool Builder*.

① 15-pin

ND 280
ND 287
EIB 74x
PWM 2x
PWT 10x

② 15-pin

TNC
iTNC
IK 220
PT 880

③ 17-pin



M23

④ 25-pin

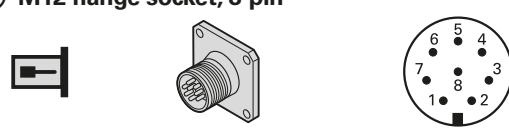
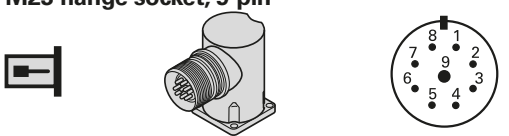
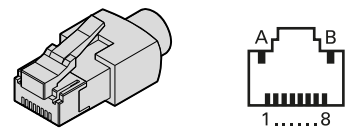

TNC
iTNC
Siemens
SMC 20

Siemens DRIVE-CLiQ

Pin layout

① M12 flange socket, 8-pin 			② M23 flange socket, 9-pin 			
③ RJ45 						
	Voltage supply			Serial data		
①	1	5	3	4	7	6
②	8	4	5	6	1	2
③	A	B	3	6	1	2
	Red	Black	Green	Yellow	Pink	Blue
	U_P	0V	RXP	RXN	TXP	TXN

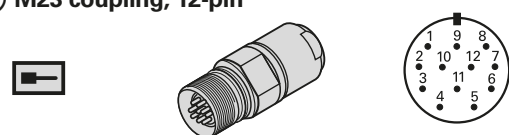
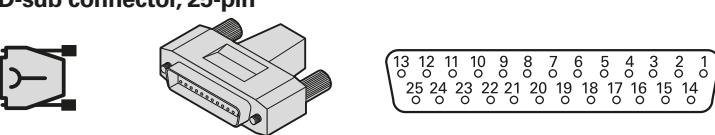
Pin layout

④ M23 coupling, 12-pin 					⑤ D-sub connector, 25-pin 								
	Voltage supply				Incremental signals						Other signals		
④	12	2	10	11	5	6	8	1	3	4	9	7	/
⑤	1	14	2	16	3	4	6	7	17	18	/	/	/
	Brown/ Green	Blue	White/ Green	White	Brown	Green	Gray	Pink	Red	Black	/	Violet	Yellow
	U_P	Sensor U _P	0V	Sensor 0V	A+	A-	B+	B-	R+	R-	Vacant	Vacant	Vacant

Cable shield connected to housing; **U_P** = Power supply voltage

Sensor: The sensor line is connected in the encoder with the corresponding power line.

Vacant pins or wires must not be used!

① 8-pin

M12

② 9-pin

M23

③ RJ45

IP20
IP67



④ 12-pin

SME 20
SME 120

⑤ 25-pin

TNC
iTNC
Siemens
SMC 20

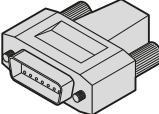
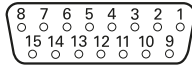
Pin layout



⑥ D-sub connector, 15-pin					⑦ M23 coupling, 17-pin								
													
	Voltage supply					Incremental signals				Serial data			
⑥	1	9	2	11	13	3	4	6	7	5	8	14	15
⑦	7	1	10	4	11	15	16	12	13	14	17	8	9
	Brown/ Green	Blue	White/ Green	White	/	Green/ Black	Yellow/ Black	Blue/ Black	Red/ Black	Gray	Pink	Violet	Yellow
	U_P	Sensor U _P	0V	Sensor 0V	Internal shield	A+	A-	B+	B-	DATA	DATA	CLOCK	CLOCK

Cable shield connected to housing; **U_P** = Power supply voltage

Sensor: The sensor line is connected in the encoder with the corresponding power line.

Vacant pins or wires must not be used!

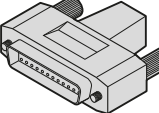
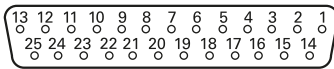
Pin layout of special cable

⑤ D-sub connector, 25-pin															
															
	Voltage supply					Incremental signals				Serial data					
⑤	1	14	2	16	3	4	6	7	15	23	10	12	13 ¹⁾	25 ¹⁾	
	Brown/ Green	Blue	White/ Green	White	Green/ Black	Yellow/ Black	Blue/ Black	Red/ Black	Red	Black	Green	Brown	Yellow	Violet	
	U_P	Sensor U _P	0V	Sensor 0V	A+	A-	B+	B-	DATA	DATA	CLOCK	CLOCK	T+	T-	

Cable shield connected to housing; **U_P** = Power supply voltage

Sensor: The sensor line is connected in the encoder with the corresponding power line.

Vacant pins or wires must not be used!

¹⁾ Only ID 509667-xx

⑥ 15-pin







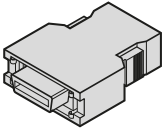
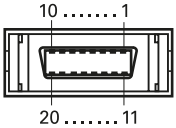

SMC 40

⑦ 17-pin

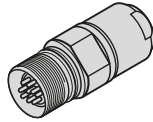
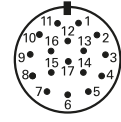
SME 25
SME 125

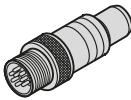
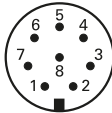
Fanuc purely serial

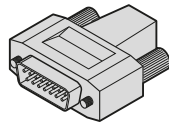
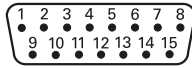
Pin layout

① Fanuc connector, 15-pin   					② M23 coupling, 17-pin   				
③ M12 coupling, 8-pin   					④ D-sub connector, 15-pin   				
	Voltage supply					Serial data			
①	9	18/20	12	14	16	1	2	5	6
②	7	1	10	4	housing	14	17	8	9
③	8	2	5	1	Housing	3	4	7	6
④	4	12	2	10	Housing	5	13	8	15
	Brown/Green	Blue	White/Green	White	/	Gray	Pink	Violet	Yellow
	U_P	Sensor U _P	0V	Sensor 0V	Shield	Serial Data	Serial Data	Request	Request

U_P = Power supply voltage

Sensor: The sensor line is connected in the encoder with the corresponding power line.

Vacant pins or wires must not be used!

For the shield connection of the Fanuc connector, see also *General electrical information* in the brochure *Interfaces of HEIDENHAIN Encoders*.

① 15-pin

Fanuc α
Fanuc αi

② 17-pin

M23



③ 8-pin

M12

④ 15-pin

Fanuc TTL

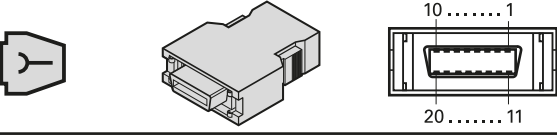
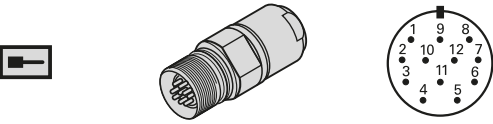
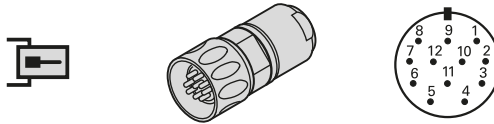
Pin layout

⑤ Fanuc connector, 15-pin 													
⑥ M23 coupling, 12-pin 						⑥ M23 connector, 12-pin 							
	Voltage supply				Incremental signals						Other signals		
⑤	9	18+20	12	14	1	2	3	4	5	6	8	7	16
⑥	12	2	10	11	5	6	8	1	3	4	7	9	Housing
	Brown/ Green	Blue	White/ Green	White	Brown	Green	Gray	Pink	Red	Black	Violet	Yellow	/
	U_P	Sensor U_P	0V	Sensor 0V	U_{a1}	\overline{U}_{a1}	U_{a2}	\overline{U}_{a2}	U_{a0}	\overline{U}_{a0}	Only 2: \overline{U}_{aS}	Only 2: PWT test pulse	Shield

U_P = Power supply voltage

Sensor: The sensor line is connected in the encoder with the corresponding power line.

Vacant pins or wires must not be used!

⑤ 15-pin

Fanuc TTL

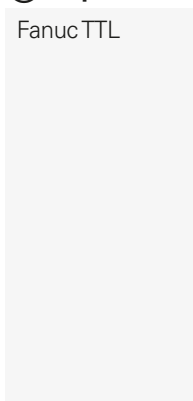



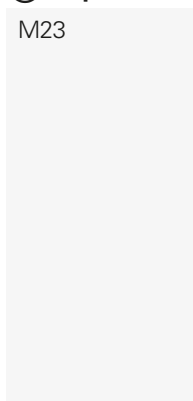

⑥ 12-pin

M23

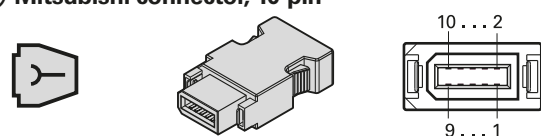
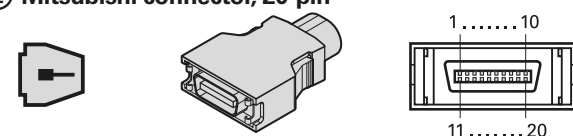
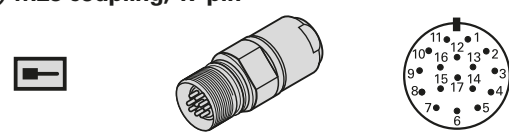
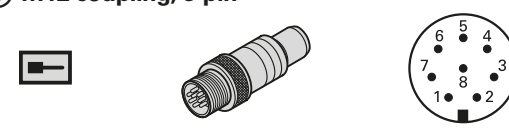
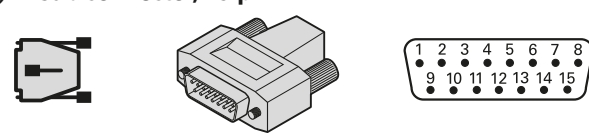

Mitsubishi

Pin layout

<p>① Mitsubishi connector, 10-pin</p> 	<p>② Mitsubishi connector, 20-pin</p> 							
<p>③ M23 coupling, 17-pin</p> 	<p>④ M12 coupling, 8-pin</p> 							
<p>⑤ D-sub connector, 15-pin</p> 								
	Voltage supply				Serial data			
①	1	/	2	/	7	8	3	4
②	20	19	1	11	6	16	7	17
③	7	1	10	4	14	17	8	9
④	8	2	5	1	3	4	7	6
⑤	4	12	2	10	5	13	8	15
	Brown/Green	Blue	White/Green	White	Gray	Pink	Violet	Yellow
Mit03-4	U_P 	Sensor U_P	0V	Sensor 0V 	Serial Data	Serial Data	Request Frame	Request Frame
Mit02-2	U_P	Sensor U_P	0V	Sensor 0V	Vacant	Vacant	Request/ Data	Request/ Data

Cable shield connected to housing; **U_P** = Power supply voltage

Sensor: The sensor line is connected in the encoder with the corresponding power line.

Vacant pins or wires must not be used!

① 10-pin

Mitsubishi

② 20-pin

Mitsubishi

③ 17-pin

M23







④ 8-pin

M12

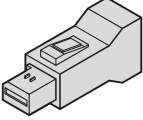
⑤ 15-pin

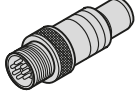
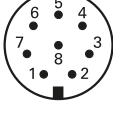
Panasonic

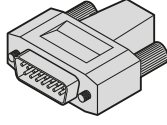
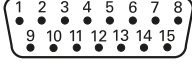
Pin layout

① Panasonic connector, 10-pin   					② M12 coupling, 8-pin   			
③ D-sub connector, 15-pin   								
	Voltage supply				Serial data			
①	1	1	2	2	/	/	3	4
②	8	2	5	1	3	4	7	6
③	4	12	2	10	5	13	8	15
	Brown/Green	Blue	White/Green	White	Gray	Pink	Violet	Yellow
	U_P	Sensor U _P	0V	Sensor 0V	Reserved, do not assign	Reserved, do not assign	Request/ Data	Request/ Data

Cable shield connected to housing; **U_P** = Power supply voltage

Sensor: The sensor line is connected in the encoder with the corresponding power line.

Vacant pins or wires must not be used!

① 10-pin

Panasonic





② 8-pin

M12

③ 15-pin

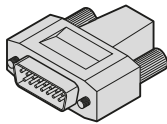
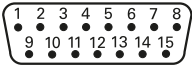
ND 280
 ND 287
 EIB 74x
 PWM 2x
 PWT 10x
 MSE 1000

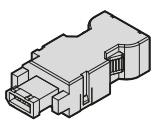
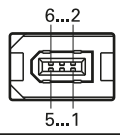
Pin layout

① D-sub connector, 15-pin					② YASKAWA connector, 6-pin			
								
	Voltage supply				Serial data			
①	4	12	2	10	/	/	8	15
②	1	1	2	2	/	/	5	6
	Brown/Green	Blue	White/Green	White	Gray	Pink	Violet	Yellow
	U_P	Sensor U _P	0V	Sensor 0V	Reserved, do not assign	Reserved, do not assign	DATA	DATA

Cable shield connected to housing; **U_P** = Power supply voltage

Sensor: The sensor line is connected in the encoder with the corresponding power line.

Vacant pins or wires must not be used!

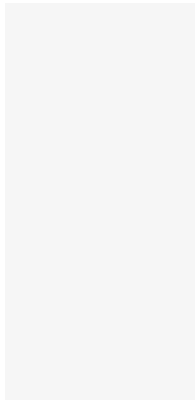

① 15-pin

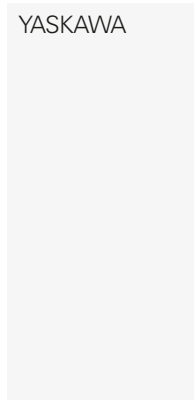

② 6-pin

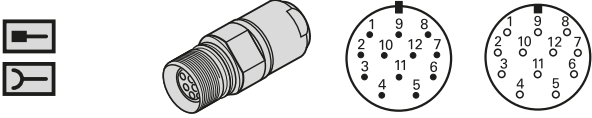
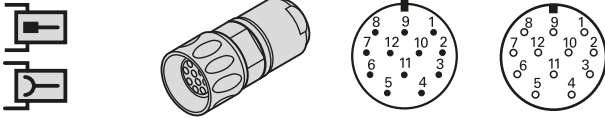
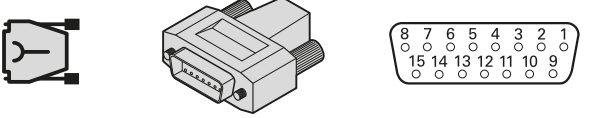
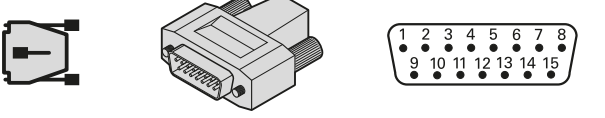
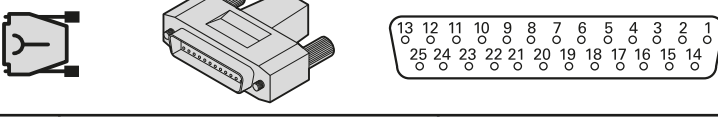

Pin layout

① M23 coupling, 12-pin 				① M23 connector, 12-pin 									
② D-sub connector, 15-pin 				③ D-sub connector, 15-pin 									
④ D-sub connector, 25-pin 													
	Voltage supply				Incremental signals						Other signals		
①	12	2	10	11	5	6	8	1	3	4	9	7	/
②	1	9	2	11	3	4	6	7	10	12	5/8/13	14	15 ¹⁾
③	4	12	2	10	1	9	3	11	14	7	5/6/8	13	15 ²⁾
④	1	14	2	16	3	4	6	7	17	18	5/8-13/ 15/19-25	/	/
	Brown/ Green	Blue	White/ Green	White	Brown	Green	Gray	Pink	Red	Black	/	Violet	Yellow
	U_P	Sensor U _P	0V	Sensor 0V	A+	A-	B+	B-	R+	R-	Vacant	Vacant	Vacant

Shield connected to housing; **U_P** = Power supply voltage

Sensor: The sensor line is connected in the encoder with the corresponding power line.

Vacant pins or wires must not be used!

¹⁾ Only ID 349687-xx, ID 360974-xx, ID 335077-xx: reserved, do not assign

²⁾ Cut off with ID 310196-xx

① 12-pin

M23
(SME 20)
(SME 120)

② 15-pin

TNC
iTNC
IK 220
PT 880
ND 700

③ 15-pin

ND 280
ND 287
ND 11xx
ND 12xx
ND 13xx
ND 14xx
ND 21xx
IK 5xxx
EIB 74x
PWM 2x
PWT 10x
MSE 1000
QC 3000



④ 25-pin

TNC
iTNC
(SMC 20)

Pin layout of special cable

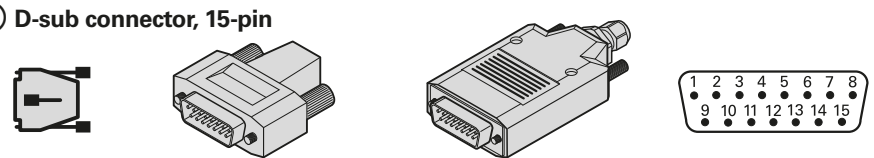
③ D-sub connector, 15-pin



	Voltage supply				Incremental signals					
③	4	12	2	10	1	9	3	11	14	7
	Brown/ Green	Blue	White/ Green	White	Brown	Green	Gray	Pink	Red	Black
	U_P	Sensor U _P	0V	Sensor 0V	A+	A-	B+	B-	R+	R-
	Other signals									
③	13 ²⁾	8 ¹⁾	6 ¹⁾	15 ²⁾	5 ²⁾	6				
	Violet	Green/Black	Yellow/Black	Yellow	Red/Black	Yellow/Black				
	Vacant	H	L	Vacant	Vacant	Vacant				
	DATA	Vacant	Vacant	CLOCK	Test	Vacant				

Shield connected to housing; **U_P** = Power supply voltage

Sensor: The sensor line is connected in the encoder with the corresponding power line.

Vacant pins or wires must not be used!

¹⁾ Only ID 354379-xx, ID 354411-xx, ID 355397-xx, ID 355398-xx

²⁾ Only ID 735541-xx: with programming line for mounting the LIP 281



Note: The listed encoders are connectable. Refer to the encoder's Product Information document for information on additional data.

③ 15-pin

ND 280
 ND 287
 ND 11xx
 ND 12xx
 ND 13xx
 ND 14xx
 ND 21xx
 IK 5xxx
 EIB 74x
 PWM 2x
 PWT 10x
 MSE 1000
 QC 3000

TTL or HTL

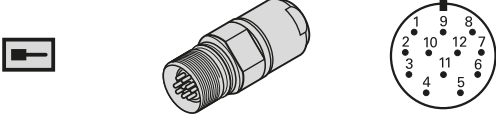
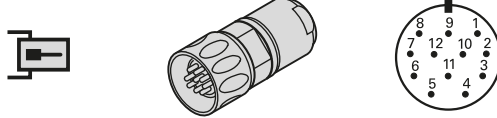
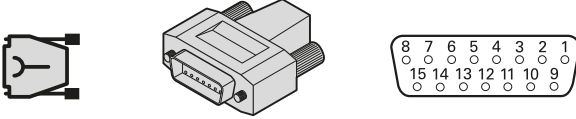
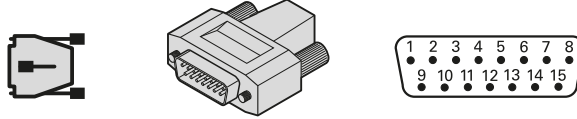
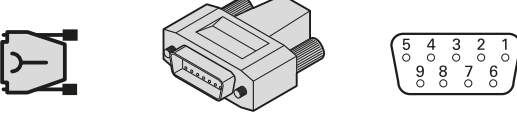
Pin layout

① M23 coupling, 12-pin 					① M23 connector, 12-pin 								
② D-sub connector, 15-pin 					③ D-sub connector, 15-pin 								
④ D-sub connector, 9-pin 													
	Voltage supply				Incremental signals						Other signals		
①	12	2	10	11	5	6	8	1	3	4	7	/	9 ²⁾
②	1	9	2	11	3	4	6	7	10	12	14	5/8/13	15 ²⁾
③	4	12	2	10	1	9	3	11	14	7	13	5/6/8	15 ²⁾
④	7	7 ³⁾	6	6 ³⁾	2	3	4	5	9	8	/	/	/
	Brown/ Green	Blue	White/ Green	White	Brown	Green	Gray	Pink	Red	Black	Violet	/	Yellow
	U_P	Sensor U_P	0V	Sensor 0V	U_{a1}	\overline{U}_{a1}	U_{a2}	\overline{U}_{a2}	U_{a0}	\overline{U}_{a0}	\overline{U}_{aS}	Vacant	Reserved, do not assign ¹⁾

Cable shield connected to housing; U_P = Power supply voltage

Sensor: The sensor line is connected in the encoder with the corresponding power line.

Vacant pins or wires must not be used!

¹⁾ **Exposed linear encoders:** TTL/11 μ App switchover for PWT, otherwise not assigned

²⁾ Cut off with: ID 298429-xx, ID 309783-xx, ID 309784-xx, ID 310196-xx, ID 310199-xx

³⁾ Only ID 617513-xx, ID 626015-xx; not with ID 617484-xx, ID 735210-xx

① 12-pin

M23

② 15-pin

③ 15-pin

PWM 2x
PWT 10x

④ 9-pin

ND 12x
ND 52x
ND 11xx
ND 12xx
ND 13xx
ND 14xx
ND 21xx
IK 5xxx
MSE 1000
QC 3000

Pin layout of special cable

③ D-sub connector, 15-pin

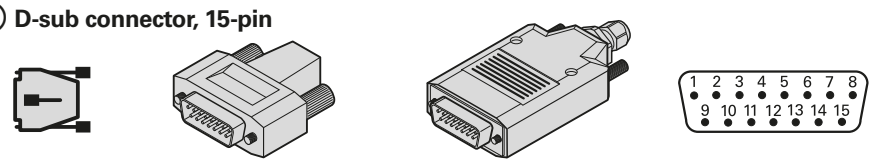

	Voltage supply				Incremental signals						Other signals			
③	4	12	2	10	1	9	3	11	14	7	13	8 ⁴⁾	6 ⁴⁾	15
	Brown/ Green	Blue	White/ Green	White	Brown	Green	Gray	Pink	Red	Black	Violet	Green/ Black	Yellow/ Black	Yellow
	U_P	Sensor 5V	0V	Sensor 0V	U_{a1}	\bar{U}_{a1}	U_{a2}	\bar{U}_{a2}	U_{a0}	\bar{U}_{a0}	\bar{U}_{aS}	L1²⁾ H³⁾	L2²⁾ L³⁾	PWT¹⁾

Cable shield connected to housing; **U_P** = Power supply voltage

Sensor: The sensor line is connected in the encoder with the corresponding power line.

Vacant pins or wires must not be used!

1) TTL/11 μ A_{PP} conversion for PWT

2) Only with LIDA 4xx

3) Only with LIF 481







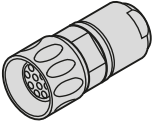

4) Only ID 354379-xx, ID 354411-xx, ID 355397-xx, ID 355398-xx

Note: The listed encoders are connectable. Refer to the encoder's Product Information document for information on additional data.

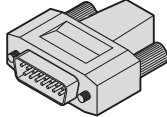
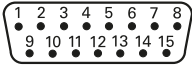
③ 15-pin

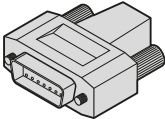
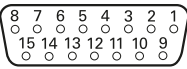
PWM 2x
PWT 10x

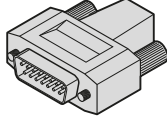
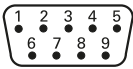
Pin layout

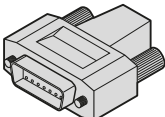
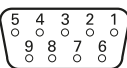
① M23 connector, 9-pin   			② D-sub connector, 15-pin   						
③ D-sub connector, 15-pin   			④ D-sub connector, 9-pin   						
⑤ D-sub connector, 9-pin   									
	Voltage supply			Incremental signals					
①	3	4	9	1	2	5	6	7	8
②	4	2	6	1	9	3	11	14	7
③	1	2	13	3	4	6	7	10	12
④	7	1	6	2	3	4	5	8	9
⑤	7	2	4	6	1	8	3	9	5
	U_P	0V	Internal shield	I_1+	I_1-	I_2+	I_2-	I_0+	I_0-

Cable shield connected to housing; U_P = Power supply voltage

Sensor: The sensor line is connected in the encoder with the corresponding power line.

Vacant pins or wires must not be used!

① 9-pin

M23

② 15-pin

ND 280
ND 287
EIB 74x
PWM 2x
PWT 10x

③ 15-pin

iTNC
IK 220
PT 880
ND 780



④ 9-pin

ND 11xx
ND 12xx
ND 12xx R
ND 21xx G

⑤ 9-pin

IK 3xx

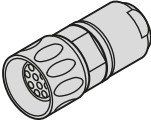
Pin layout of special cable

① M23 connector, 9-pin									
									
	Voltage supply			Incremental signals					
①	3	4	9	1	2	5	6	7	8
 1)	Brown	White	Internal shield	Green	Yellow	Blue	Red	Gray	Pink
	U_P	0V	Internal shield	I₁₊	I₁₋	I₂₊	I₂₋	I₀₊	I₀₋







Cable shield connected to housing; **U_P** = Power supply voltage

Sensor: The sensor line is connected in the encoder with the corresponding power line.

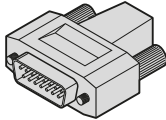
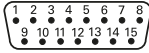
Vacant pins or wires must not be used!

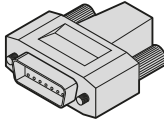
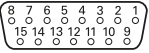
1) Only ID 309780-xx

Pin layout of special adapter cable, 1 V_{PP}

③ D-sub connector, 15-pin					③ D-sub connector, 15-pin								
													
	Voltage supply				Incremental signals						Other signals		
③	1	9	2	11	3	4	6	7	10	12	5/8/ 13/15	14 ¹⁾	/
	Brown/ Green	Blue	White/ Green	White	Brown	Green	Gray	Pink	Red	Black	/	Violet	Yellow
11 μA _{PP}	U_P	Sensor U _P	0V	Sensor 0V	I₁₊	I₁₋	I₂₊	I₂₋	I₀₊	I₀₋	Reserved, do not assign	Reserved, do not assign	Reserved, do not assign
1 V _{PP}					A+	A-	B+	B-	R+	R-			

Cable shield connected to housing; **U_P** = Power supply voltage

Sensor: The sensor line is connected in the encoder with the corresponding power line.

Vacant pins or wires must not be used!

1) Only on 1 V_{PP}-output

① 9-pin

M23

③ 15-pin

iTNC
IK 220
PT 880
ND 780

Touch probes – SE

Pin layout

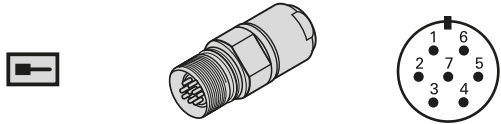
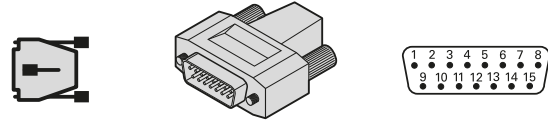
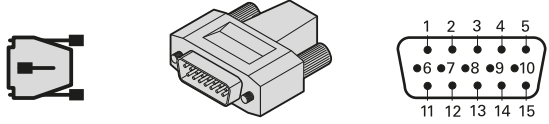
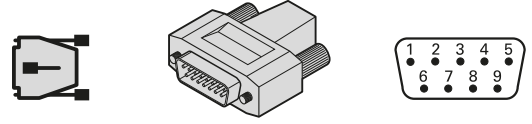
① M23 coupling, 7-pin 					② D-sub connector, 2-row, 15-pin 											
③ D-sub connector, 3-row, 15-pin 					④ D-sub connector, 2-row, 9-pin 											
	Voltage supply					Signals							Serial data			
①	2	/	1	/	7	3	/	5	/	4	6	/	/	/	/	/
②	5, 6 ¹⁾	/	8	/	1	4	/	3	/	10	7	/	/	/	/	/
③	10	10	9	8	/	6	7	3	11	2	4	/	12	13	14	15
④	4	/	2	/	/	/	/	/	1	9	/	8	/	/	/	/
	U_P	Sensor U_P	0V	Sensor 0V	Internal shield	R(TS)	R(TT)	B(TS)	B(TT)	S̄	W̄	S	DATA	DATA	CLOCK	CLOCK

External shield lies on connector housing.

U_P = Voltage supply; **R** = Start signal; **B** = Ready signal; **S**, **S̄** = Trigger signal; **W̄** = Battery warning

Sensor: The sensor line is connected in the encoder with the corresponding power line.

Vacant pins or wires must not be used!

¹⁾ Only ID 701919-xx

① 7-pin

M23

② 15-pin

TNC



③ 15-pin

PLB 62xx
UEC 11x
UMC 11x

④ 9-pin

TNC 128
TNC 320

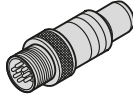
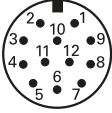
Pin layout

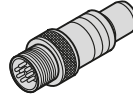
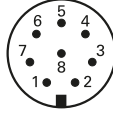
⑤ M12 coupling, 12-pin					⑥ M12 coupling, 8-pin								
													
	Voltage supply				Signals or serial data								
⑤	1	/	12	/	11	5	2	10	3	4	6	7	8
⑥	1	8	5	2	/	/	/	/	3	4	6	7	/
⑤	U _P	/	0V	/	R(TS)	R(TT)	B(TS)	B(TT)	S	\bar{S}	\bar{W}	SEL(0)	SEL(1)
⑥	U _P	Sensor U _P	0V	Sensor 0V	/	/	/	/	DATA	\bar{DATA}	\bar{CLOCK}	CLOCK	/

External shield lies on connector housing.

U_P = Voltage supply; R = Start signal; B = Ready signal; S, \bar{S} = Trigger signal; \bar{W} = Battery warning

SEL(0) = Selection 0 (depends on variant); SEL(1) = Selection 1 (depends on variant)

Vacant pins or wires must not be used!

Pin layout of special cable

⑦ Free cable end												
												
	Voltage supply		Signals									
⑦ ¹⁾	Brown/ Green	White/ Green	Blue	White	Green	Brown	Gray	Pink	Violet	Yellow	Red	Black
⑦ ²⁾	Brown	White	Yellow	/	Gray	/	/	Green	Blue	/	/	/
	U _P	0V	R(TS)	R(TT)	B(TS)	B(TT)	S	\bar{S}	\bar{W}	/	SEL(0)	SEL(1)

External shield lies on connector housing.

U_P = Voltage supply; R = Start signal; B = Ready signal; S, \bar{S} = Trigger signal; \bar{W} = Battery warning

SEL(0) = Selection 0 (depends on variant); SEL(1) = Selection 1 (depends on variant)

Vacant pins or wires must not be used!

¹⁾ Only ID 801285-xx

²⁾ Only ID 310193-xx

⑤ 12-pin

M12

⑥ 8-pin



M12

⑦ Free cable end

F*/S/M

Touch probes – TS

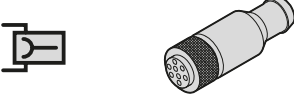
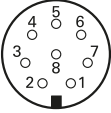
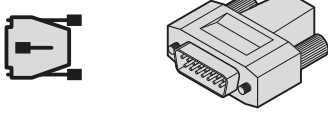
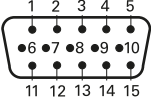
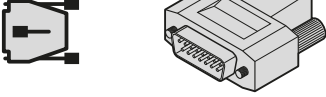
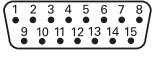
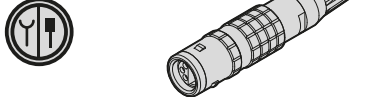
Pin layout

① M12 connector, 8-pin  			② D-sub connector, 3-row, 15-pin  					
③ D-sub connector, 2-row, 15-pin  			④ Quick connection, 6-pin  					
	Voltage supply		Signals					
①	2	7	3	4	1	5	6	8
②	10	9	1	2	3	/	/	/
③	5	8	9	10	3	14 ¹⁾	11 ¹⁾	12 ¹⁾
④	3	1	5	6	3/4	/	/	/
	U_P	0V	S	\bar{S}	B	Trigger NO	Trigger NC	Trigger 0V

External shield lies on connector housing.

U_P = Voltage supply; **B** = Ready signal; **S**, **\bar{S}** = Trigger signal

Trigger = Floating switching outputs (NC = normally closed, NO = normally open)

Vacant pins or wires must not be used!

¹⁾ Not with ID 274543-xx

① 8-pin

M12

② 15-pin

PLB 62xx
UEC 11x
UMC 11x

③ 15-pin

TNC
iTNC

④ 6-pin

Pin layout

⑤ Free cable end 								
	Voltage supply		Signals					
⑤ ¹⁾	Blue	Violet	Gray	Pink	White	White/Green	Yellow	Brown/Green
⑤ ²⁾	Gray	White/Green	Green	Yellow	Pink	/	/	/
⑤ ³⁾	Brown	White	Green	Yellow	Vacant	Vacant	Vacant	Vacant
	U_P	0V	S	\bar{S}	B	Trigger NO	Trigger NC	Trigger 0V

External shield lies on connector housing.

U_P = Voltage supply; **B** = Ready signal; **S**, **\bar{S}** = Trigger signal

Trigger = Floating switching outputs (NC = normally closed, NO = normally open)

Vacant pins or wires must not be used!

¹⁾ Only ID 634265-xx

²⁾ Only ID 274544-xx

³⁾ Only ID 1180354-xx

⑤ Free cable end

F*/S/M

Touch probes – TT

Pin layout

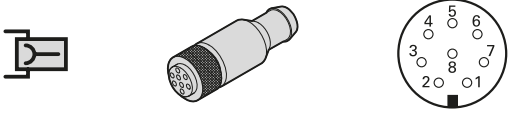
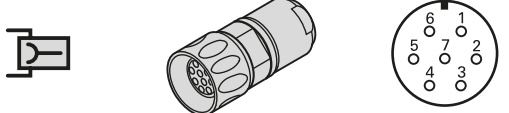
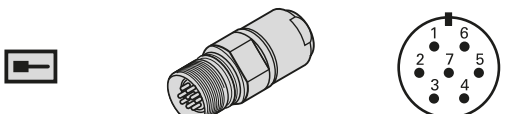
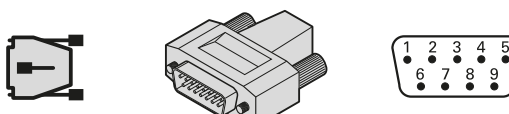
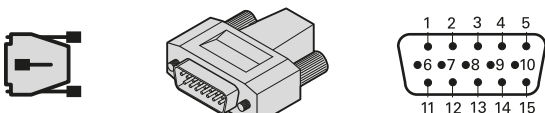
<p>① M12 connector, 8-pin</p> 	<p>② M23 connector, 7-pin</p> 				
<p>② M23 coupling, 7-pin</p> 	<p>③ D-sub connector, 9-pin</p> 				
<p>④ D-sub connector, 3-row, 15-pin</p> 					
	Voltage supply		Signals		
①	2	7	3	4	1
②	2+5	1	3	4	6
③	4	2	8	9	1
④	10	9	1	2	11
	U _P	0V	S	S̄	B

External shield lies on connector housing.

U_P = Voltage supply; B = Ready signal; S, S̄ = Trigger signal

Vacant pins or wires must not be used!

① 8-pin

M12

② 7-pin

M23



③ 9-pin

TNC
(>LE 4xx)

④ 15-pin

PLB 62xx
UEC 11x
UMC 11x

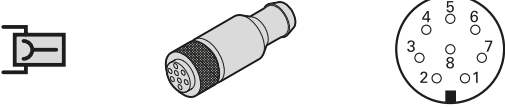
Pin layout of special cable

① M12 connector, 8-pin 			⑤ Free cable end 					
	Voltage supply		Signals					
①	2	7	3	4	1	5	6	8
⑤ ¹⁾	Blue	Violet	Gray	Pink	White	White/Green	Yellow	Brown/Green
	U_P	0V	S	\bar{S}	B	Trigger NO	Trigger NC	Trigger 0V

External shield lies on connector housing.

U_P = Voltage supply; **B** = Ready signal; **S, \bar{S}** = Trigger signal

Trigger = Floating switching outputs (NC = normally closed, NO = normally open)

Vacant pins or wires must not be used!

¹⁾ Only ID 606317-xx, ID 634265-xx, ID 1083190-xx

⑤ Free cable end

F*/S/M

Laser systems

Pin layout

① M23 connector, 12-pin

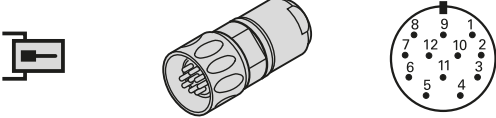

	Voltage supply		Signals			Outputs		
①	2	1	4	12	6	3	5	7
	Brown	White	Yellow	Pink	Violet	Green	Gray	Blue
	24V	0V	ENABLE 0	ENABLE 1	ENABLE 2	DYN	STA	LASER OK

② D-sub connector, 9-pin

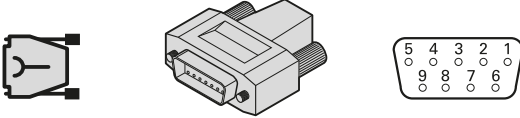

	Inputs	
②	White	Brown
	0V	DYN

Cable shield lies on connector housing.
Vacant pins or wires must not be used!

③ D-sub connector, 3-row, 15-pin

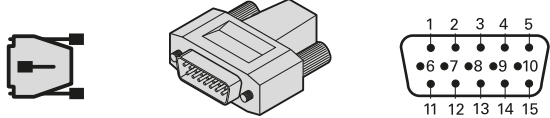

	Voltage supply		Signal
③	10	8	1
	Brown	White	Green
	24V	0V	Trigger signal

Cable shield lies on connector housing.
Vacant pins or wires must not be used!

④ DA 301 TL cable

	Outputs			
④	1	2	3	4
	Brown	White	Blue	Black
	Blow nozzle for tool cleaning	Contamination shutter	0V	Sealing air

① 12-pin

TL

② 9-pin

TNC 320
TNC 426
TNC 430
iTNC 530

③ 15-pin

TNC 640
TNC 620
iTNC 530 HSCI

④

DA 301 TL

HEIDENHAIN

DR. JOHANNES HEIDENHAIN GmbH

Dr.-Johannes-Heidenhain-Straße 5

83301 Traunreut, Germany

☎ +49 8669 31-0

FAX +49 8669 32-5061

E-mail: info@heidenhain.de

www.heidenhain.de

Vollständige und weitere Adressen siehe www.heidenhain.de
For complete and further addresses see www.heidenhain.de

DE	HEIDENHAIN Vertrieb Deutschland 83301 Traunreut, Deutschland ☎ 08669 31-3132 FAX 08669 32-3132 E-Mail: hd@heidenhain.de	ES	FARRESA ELECTRONICA S.A. 08028 Barcelona, Spain www.farresa.es	PH	MACHINEBANKS' CORPORATION Quezon City, Philippines 1113 E-mail: info@machinebanks.com
	HEIDENHAIN Technisches Büro Nord 12681 Berlin, Deutschland ☎ 030 54705-240	FI	HEIDENHAIN Scandinavia AB 01740 Vantaa, Finland www.heidenhain.fi	PL	APS 02-384 Warszawa, Poland www.heidenhain.pl
	HEIDENHAIN Technisches Büro Mitte 07751 Jena, Deutschland ☎ 03641 4728-250	FR	HEIDENHAIN FRANCE sarl 92310 Sèvres, France www.heidenhain.fr	PT	FARRESA ELECTRÓNICA, LDA. 4470 - 177 Maia, Portugal www.farresa.pt
	HEIDENHAIN Technisches Büro West 44379 Dortmund, Deutschland ☎ 0231 618083-0	GB	HEIDENHAIN (G.B.) Limited Burgess Hill RH15 9RD, United Kingdom www.heidenhain.co.uk	RO	HEIDENHAIN Reprezentantă Romania Braşov, 500407, Romania www.heidenhain.ro
	HEIDENHAIN Technisches Büro Südwest 70771 Leinfelden-Echterdingen, Deutschland ☎ 0711 993395-0	GR	MB Milionis Vassilis 17341 Athens, Greece www.heidenhain.gr	RS	Serbia → BG
	HEIDENHAIN Technisches Büro Südost 83301 Traunreut, Deutschland ☎ 08669 31-1345	HK	HEIDENHAIN LTD Kowloon, Hong Kong E-mail: sales@heidenhain.com.hk	RU	OOO HEIDENHAIN 115172 Moscow, Russia www.heidenhain.ru
		HR	Croatia → SL	SE	HEIDENHAIN Scandinavia AB 12739 Skärholmen, Sweden www.heidenhain.se
AR	NAKASE SRL. B1653AOX Villa Ballester, Argentina www.heidenhain.com.ar	HU	HEIDENHAIN Kereskedelmi Képviselet 1239 Budapest, Hungary www.heidenhain.hu	SG	HEIDENHAIN PACIFIC PTE LTD Singapore 408593 www.heidenhain.com.sg
AT	HEIDENHAIN Techn. Büro Österreich 83301 Traunreut, Germany www.heidenhain.de	ID	PT Servitama Era Toolsindo Jakarta 13930, Indonesia E-mail: ptset@group.gts.co.id	SK	KOPRETINA TN s.r.o. 91101 Trenčín, Slovakia www.kopretina.sk
AU	FCR MOTION TECHNOLOGY PTY LTD Laverton North Victoria 3026, Australia E-mail: sales@fcrmotion.com	IL	NEUMO VARGUS MARKETING LTD. Holon, 58859, Israel E-mail: neumo@neumo-vargus.co.il	SL	NAVO d.o.o. 2000 Maribor, Slovenia www.heidenhain.si
BE	HEIDENHAIN NV/SA 1760 Roosdaal, Belgium www.heidenhain.be	IN	HEIDENHAIN Optics & Electronics India Private Limited Chetpet, Chennai 600 031, India www.heidenhain.in	TH	HEIDENHAIN (THAILAND) LTD Bangkok 10250, Thailand www.heidenhain.co.th
BG	ESD Bulgaria Ltd. Sofia 1172, Bulgaria www.esd.bg	IT	HEIDENHAIN ITALIANA S.r.l. 20128 Milano, Italy www.heidenhain.it	TR	T&M Mühendislik San. ve Tic. LTD. ŞTİ. 34775 Y. Dudullu – Umraniye-Istanbul, Turkey www.heidenhain.com.tr
BR	HEIDENHAIN Brasil Ltda. 04763-070 – São Paulo – SP, Brazil www.heidenhain.com.br	JP	HEIDENHAIN K.K. Tokyo 102-0083, Japan www.heidenhain.co.jp	TW	HEIDENHAIN Co., Ltd. Taichung 40768, Taiwan R.O.C. www.heidenhain.com.tw
BY	GERTNER Service GmbH 220026 Minsk, Belarus www.heidenhain.by	KR	HEIDENHAIN Korea LTD. Gasan-Dong, Seoul, Korea 153-782 www.heidenhain.co.kr	UA	Gertner Service GmbH Büro Kiev 02094 Kiev, Ukraine www.heidenhain.ua
CA	HEIDENHAIN CORPORATION Mississauga, Ontario L5T2N2, Canada www.heidenhain.com	MX	HEIDENHAIN CORPORATION MEXICO 20290 Aguascalientes, AGS., Mexico E-mail: info@heidenhain.com	US	HEIDENHAIN CORPORATION Schaumburg, IL 60173-5337, USA www.heidenhain.com
CH	HEIDENHAIN (SCHWEIZ) AG 8603 Schwerzenbach, Switzerland www.heidenhain.ch	MY	ISOSERVE SDN. BHD. 43200 Balakong, Selangor E-mail: sales@isoserve.com.my	VE	Maquinaria Diekmann S.A. Caracas, 1040-A, Venezuela E-mail: purchase@diekmann.com.ve
CN	DR. JOHANNES HEIDENHAIN (CHINA) Co., Ltd. Beijing 101312, China www.heidenhain.com.cn	NL	HEIDENHAIN NEDERLAND B.V. 6716 BM Ede, Netherlands www.heidenhain.nl	VN	AMS Co. Ltd HCM City, Vietnam E-mail: davidgoh@amsvn.com
CZ	HEIDENHAIN s.r.o. 102 00 Praha 10, Czech Republic www.heidenhain.cz	NO	HEIDENHAIN Scandinavia AB 7300 Orkanger, Norway www.heidenhain.no	ZA	MAFEMA SALES SERVICES C.C. Midrand 1685, South Africa www.heidenhain.co.za
DK	TPTEKNIK A/S 2670 Greve, Denmark www.tp-gruppen.dk	NZ	Llama ENGINEERING Ltd 5012 Wellington, New Zealand E-mail: info@llamaengineering.co.nz		

