

PLEASE CHECK WWW.MOLEX.COM FOR LATEST PART INFORMATION

Part Number: [30700-5208](#)
Status: **Active**
Overview: H-DAC 64™ Dual-Row High Density Automotive Connectors
Description: 2.54mmPitch, H-DAC 64™ High Density Automotive Header, Dual Row, Right Angle, 20 Circuits, Polarization Option 2, Black

Documents:

[3D Model](#) [Product Specification PS-30700-0001 \(PDF\)](#)
[Drawing \(PDF\)](#) [RoHS Certificate of Compliance \(PDF\)](#)

General

Product Family	PCB Headers
Series	30700
Application	Board-to-Board, Power
Comments	Polarization Option 2
Overview	H-DAC 64™ Dual-Row High Density Automotive Connectors
Product Name	H-DAC 64™
UPC	822348101702

Physical

Breakaway	No
Circuits (Loaded)	20
Circuits (maximum)	20
Color - Resin	Black
Durability (mating cycles max)	10
First Mate / Last Break	No
Glow-Wire Compliant	No
Guide to Mating Part	No
Keying to Mating Part	None
Lock to Mating Part	Yes
Material - Metal	Copper
Material - Plating Mating	Tin
Material - Plating Termination	Nickel
Material - Resin	Modified Polystyrene
Net Weight	7.128/g
Number of Rows	2
Orientation	Right Angle
PC Tail Length	3.69mm
PCB Locator	Yes
PCB Retention	Yes
PCB Thickness - Recommended	1.57mm
Packaging Type	Tray
Pitch - Mating Interface	2.54mm
Polarized to Mating Part	Yes
Polarized to PCB	Yes
Shrouded	Fully
Stackable	No
Surface Mount Compatible (SMC)	No
Temperature Range - Operating	-40°C to +100°C
Termination Interface: Style	Through Hole

Electrical

Current - Maximum per Contact	7A
Voltage - Maximum	500V DC

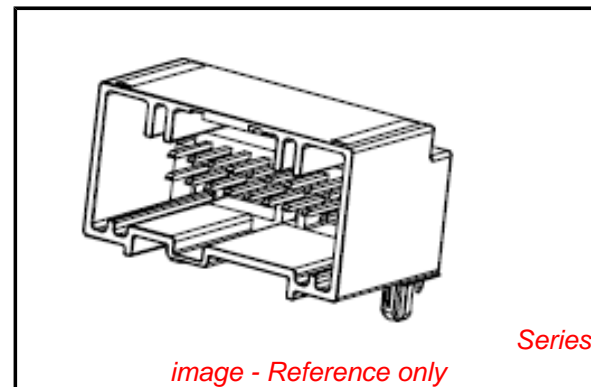

image - Reference only

EU RoHS

ELV and RoHS Compliant

REACH SVHC

Not Reviewed

Low-Halogen Status

Low-Halogen

China RoHS



Need more information on product environmental compliance?

Email productcompliance@molex.com
 For a multiple part number RoHS Certificate of Compliance, [click here](#)

Please visit the [Contact Us](#) section for any non-product compliance questions.

Search Parts in this Series

[30700Series](#)

Mates With

[30700 H-DAC 64™ High Density Crimp Housing](#)

Solder Process Data

Duration at Max. Process Temperature (seconds)	40
Lead-free Process Capability	SMC & Wave Capable (TH only)
Max. Cycles at Max. Process Temperature	3
Process Temperature max. C	260

Material Info**Reference - Drawing Numbers**

Product Specification	PS-30700-0001
Sales Drawing	SD-30700-520

This document was generated on 06/26/2013

PLEASE CHECK WWW.MOLEX.COM FOR LATEST PART INFORMATION