



RAYCHEM

TE Internal #: 820091-000

Cable Transitions & Breakouts, T Shape, 3 Branches , 25, 25, -75 – 150 °C [-103 – 302 °F], S1125, Long-Term Fluid Exposure at High Temperatures

[View on TE.com >](#)

Wire Protection & Management > Heat Shrink Shapes > Cable Transitions & Breakouts

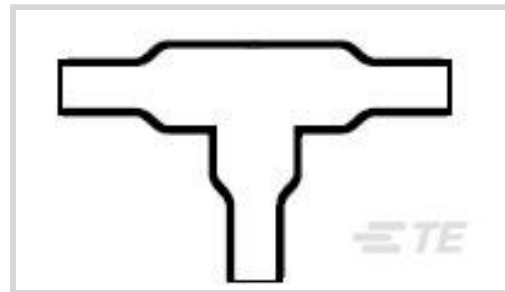

Molded Part Shape: **T Shape**

Number of Branches & Legs: **3**

Material Code: **25**

Material Systems Code: **25**

Adhesive Requirement: **Adhesive Purchased Separately**

Features

Product Type Features

Molded Part Shape	T Shape
-------------------	---------

Configuration Features

Number of Branches & Legs	3
Adhesive Requirement	Adhesive Purchased Separately

Body Features

Primary Product Material	Fluid Resistant Modified Elastomer
Material Code	25
Material Systems Code	25

Dimensions

Inside Diameter Range (Leg 2)	3.6 – 6.6 mm [.14 – .26 in]
Inside Diameter Range (Body)	3.6 – 6.6 mm [.14 – .26 in]
Inside Diameter Range (Leg 1)	3.6 – 6.6 mm [.14 – .26 in]

Usage Conditions

Operating Temperature Range	-75 – 150 °C [-103 – 302 °F]
Resistance Protection	Long-Term Fluid Exposure at High Temperatures

Other

Size Code	011
-----------	-----

Molded Part Shape Code	301A
------------------------	------

Adhesive Code	S1125
---------------	-------

Product Compliance

[For compliance documentation, visit the product page on TE.com>](#)

EU RoHS Directive 2011/65/EU	Compliant
EU ELV Directive 2000/53/EC	Compliant
China RoHS 2 Directive MIIT Order No 32, 2016	No Restricted Materials Above Threshold
EU REACH Regulation (EC) No. 1907/2006	Current ECHA Candidate List: JUNE 2024 (241) Candidate List Declared Against: JAN 2024 (240) Does not contain REACH SVHC
Halogen Content	Not Low Halogen - contains Br or Cl > 900 ppm.
Solder Process Capability	Not applicable for solder process capability

Product Compliance Disclaimer

This information is provided based on reasonable inquiry of our suppliers and represents our current actual knowledge based on the information they provided. This information is subject to change. The part numbers that TE has identified as EU RoHS compliant have a maximum concentration of 0.1% by weight in homogenous materials for lead, hexavalent chromium, mercury, PBB, PBDE, DBP, BBP, DEHP, DIBP, and 0.01% for cadmium, or qualify for an exemption to these limits as defined in the Annexes of Directive 2011/65/EU (RoHS2). Finished electrical and electronic equipment products will be CE marked as required by Directive 2011/65/EU. Components may not be CE marked. Additionally, the part numbers that TE has identified as EU ELV compliant have a maximum concentration of 0.1% by weight in homogenous materials for lead, hexavalent chromium, and mercury, and 0.01% for cadmium, or qualify for an exemption to these limits as defined in the Annexes of Directive 2000/53/EC (ELV). Regarding the REACH Regulation, the information TE provides on SVHC in articles for this part number is based on the latest European Chemicals Agency (ECHA) 'Guidance on requirements for substances in articles' posted at this URL: <https://echa.europa.eu/guidance-documents/guidance-on-reach>

Compatible Parts

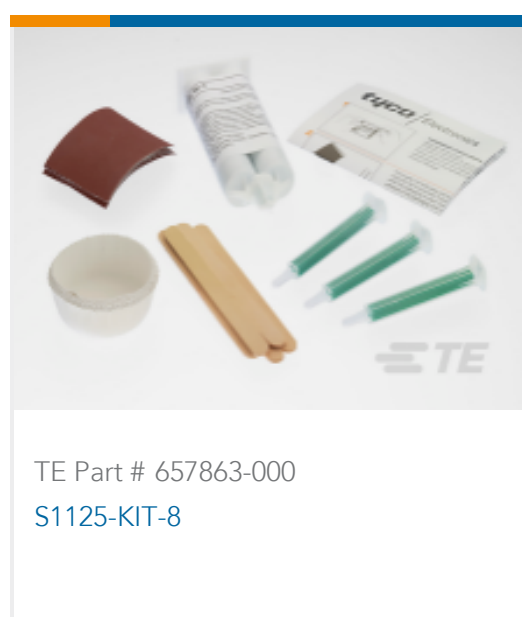

Customers Also Bought

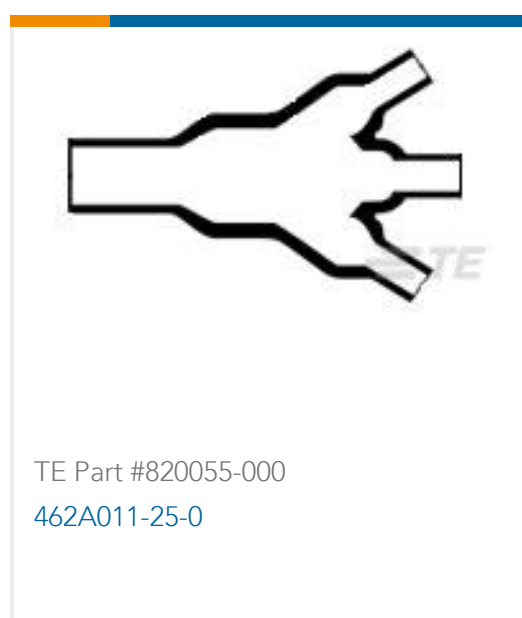
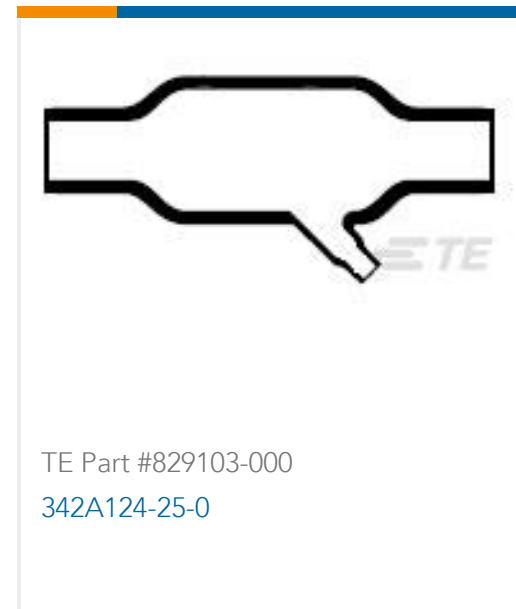
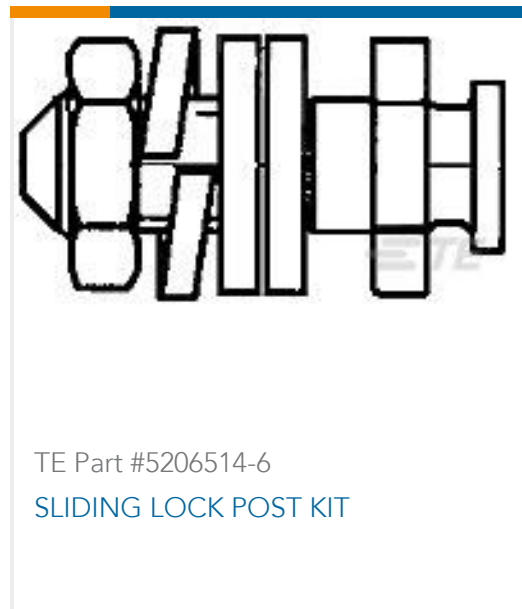
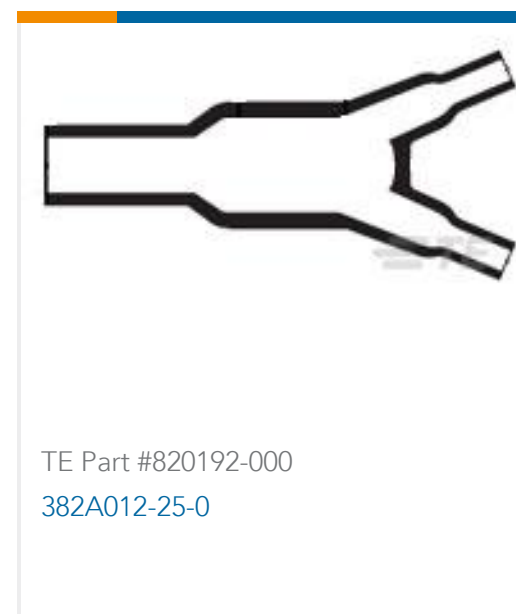
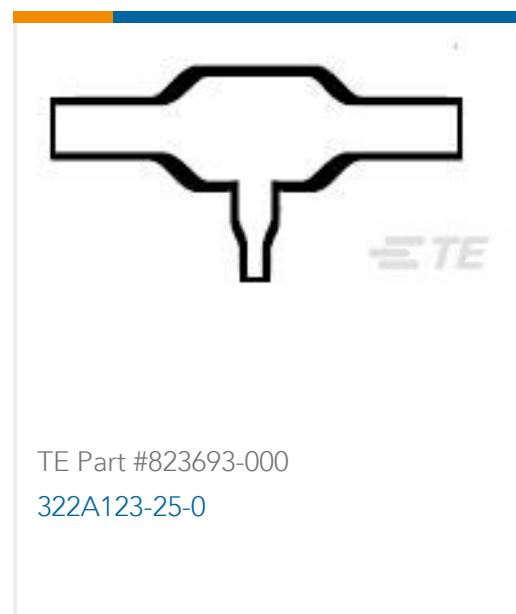

Documents

Product Drawings

[301A011-25-0](#)

English

Datasheets & Catalog Pages

[1654025_Sec4_-25](#)

English

Raychem Molded Parts Visual Guide

English

Solutions for Defense Applications Certified to VG Standards

English

Product Specifications

[Product Specification](#)

English