

3-646356-0 ✓ ACTIVE



Z-PACK | Z-PACK 2mm HM

TE Internal #: 3-646356-0

Hard Metric Backplane Connectors, PCB Mount Header, ≤ 1 Gb/s, 25 Column, 8 Row, 220 Position, 2 mm Centerline, Vertical, Gray, Tube, Z-PACK 2mm HM

[View on TE.com >](#)

Connectors > PCB Connectors > Backplane Connectors > Hard Metric Backplane Connectors >

Hard Metric Male Connector: Traditional Backplane, Mezzanine, 2mm

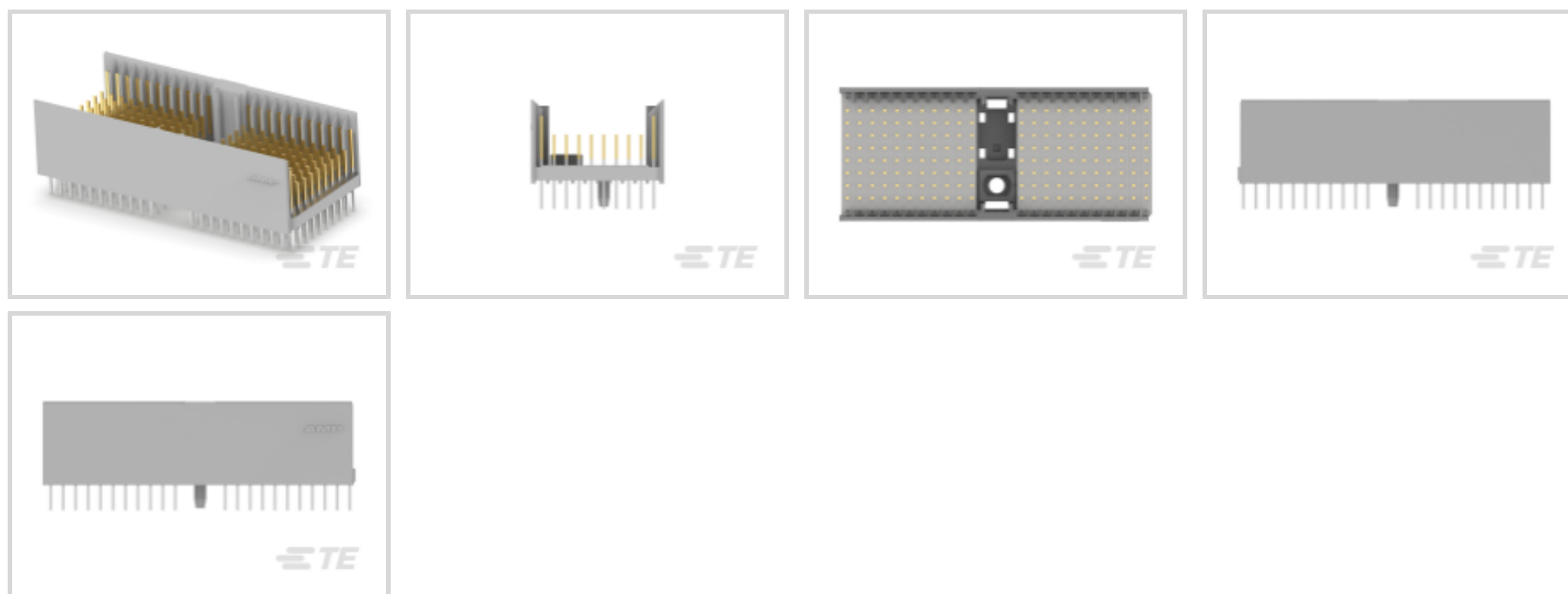

PCB Connector Assembly Type: **PCB Mount Header**

Data Rate: ≤ 1 Gb/s

Number of Columns: **25**

Number of Rows: **8**

Connector System: **Board-to-Board**

[All Hard Metric Male Connector: Traditional Backplane, Mezzanine, 2mm \(124\)](#)

Features

Product Type Features

PCB Connector Assembly Type	PCB Mount Header
Connector System	Board-to-Board
Sealable	No
Connector & Contact Terminates To	Printed Circuit Board

Configuration Features

Number of Columns	25
Number of Rows	8
Number of Positions	220
PCB Mount Orientation	Vertical

Signal Characteristics

Data Rate	≤ 1 Gb/s
-----------	---------------



Body Features

Primary Product Color	Gray
-----------------------	------

Contact Features

CompactPCI Designation	None
Contact Mating Area Plating Material	Gold
Contact Current Rating (Max)	1.5 A

Mechanical Attachment

Connector Mounting Type	Board Mount
-------------------------	-------------

Housing Features

Centerline (Pitch)	2 mm
--------------------	------

Usage Conditions

Operating Temperature Range	-55 – 125 °C
-----------------------------	--------------

Operation/Application

Circuit Application	Power & Signal
---------------------	----------------

Packaging Features

Packaging Method	Tube
------------------	------

Product Compliance

[For compliance documentation, visit the product page on TE.com>](#)

EU RoHS Directive 2011/65/EU	Not Compliant
EU ELV Directive 2000/53/EC	Compliant with Exemptions
China RoHS 2 Directive MIIT Order No 32, 2016	Restricted Materials Above Threshold
EU REACH Regulation (EC) No. 1907/2006	Current ECHA Candidate List: JUNE 2023 (235) Candidate List Declared Against: JUNE 2023 (235) SVHC > Threshold: Pb (13% in Component Part) Article Safe Usage Statements: Do not eat, drink or smoke when using this product. Wash thoroughly after handling. Recycle if possible and dispose of the article by following all applicable governmental regulations relevant to your geographic location.
Halogen Content	Not Low Halogen - contains Br or Cl > 900 ppm.
Solder Process Capability	Not applicable for solder process capability

Product Compliance Disclaimer

This information is provided based on reasonable inquiry of our suppliers and represents our current actual knowledge based on the information they provided. This information is subject to change. The part numbers that TE has identified as EU RoHS compliant have a maximum concentration of 0.1% by weight in homogenous materials for lead, hexavalent chromium, mercury, PBB, PBDE, DBP, BBP, DEHP, DIBP, and 0.01% for cadmium, or qualify for an exemption to these limits as defined in the Annexes of Directive 2011/65/EU (RoHS2). Finished electrical and electronic equipment products will be CE marked as required by Directive 2011/65/EU. Components may not be CE marked. Additionally, the part numbers that TE has identified as EU ELV compliant have a maximum concentration of 0.1% by weight in homogenous materials for lead, hexavalent chromium, and mercury, and 0.01% for cadmium, or qualify for an exemption to these limits as defined in the Annexes of Directive 2000/53/EC (ELV). Regarding the REACH Regulation, the information TE provides on SVHC in articles for this part number is based on the latest European Chemicals Agency (ECHA) 'Guidance on requirements for substances in articles' posted at this URL: <https://echa.europa.eu/guidance-documents/guidance-on-reach>

Compatible Parts



Also in the Series | Z-PACK 2mm HM

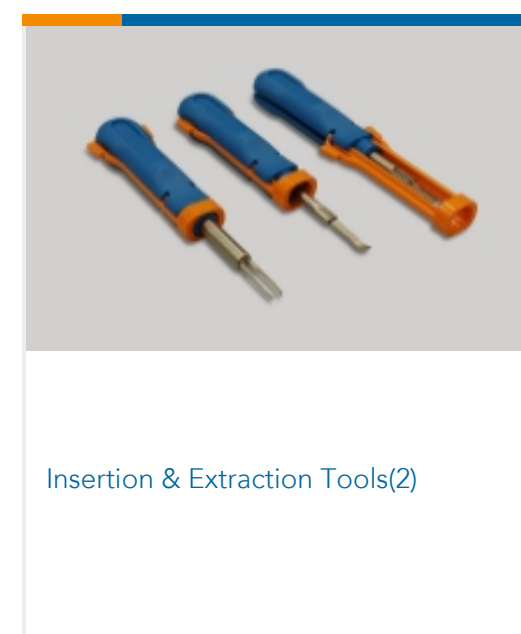
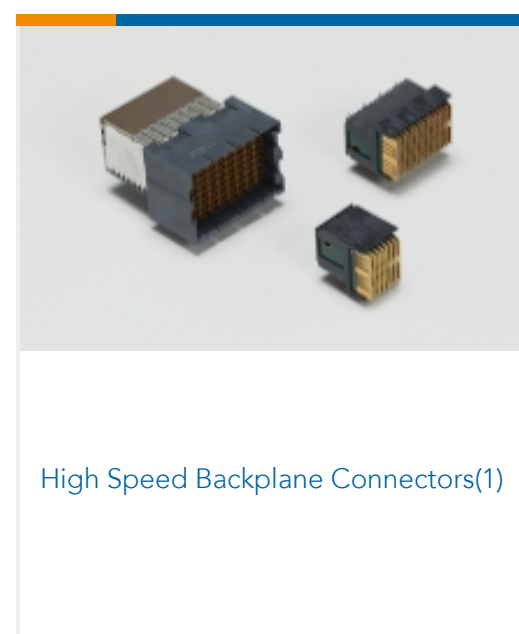
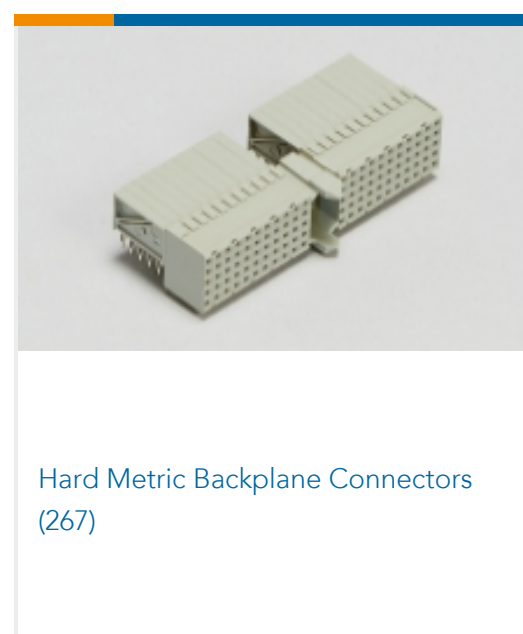
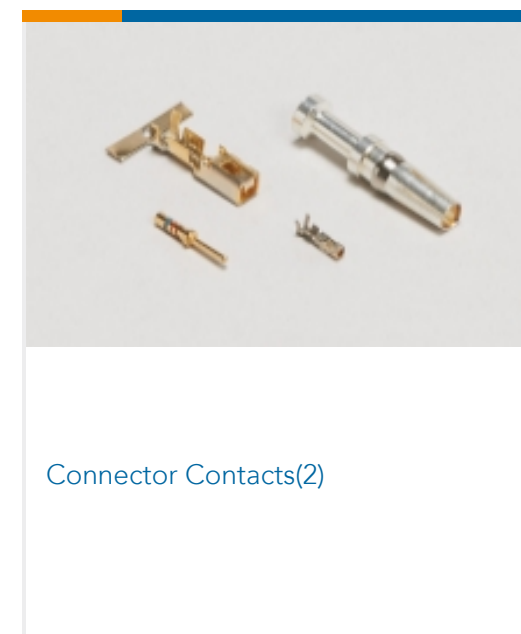
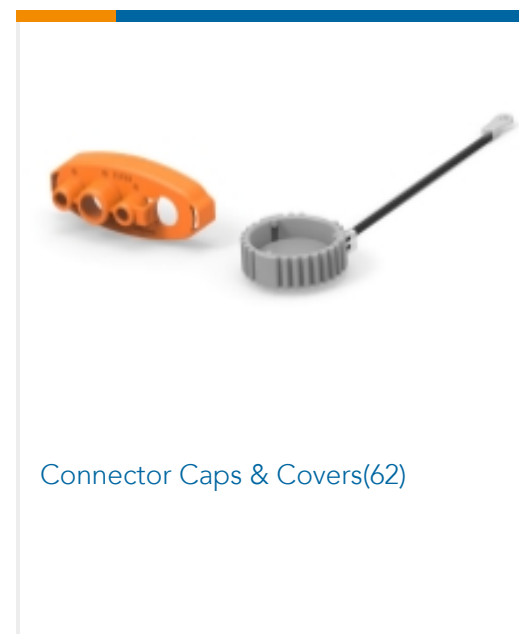
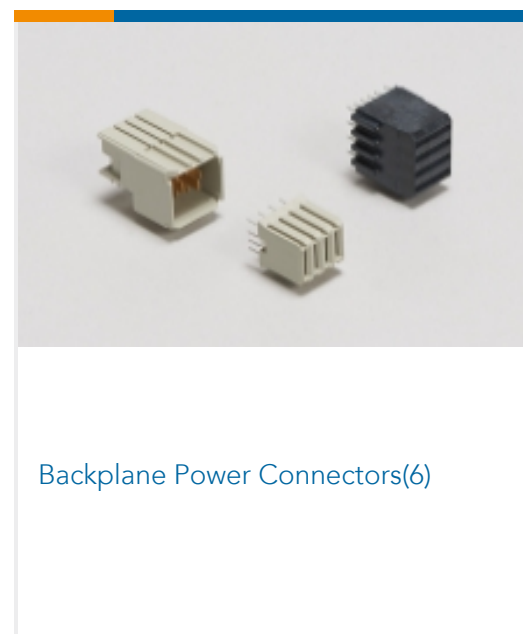
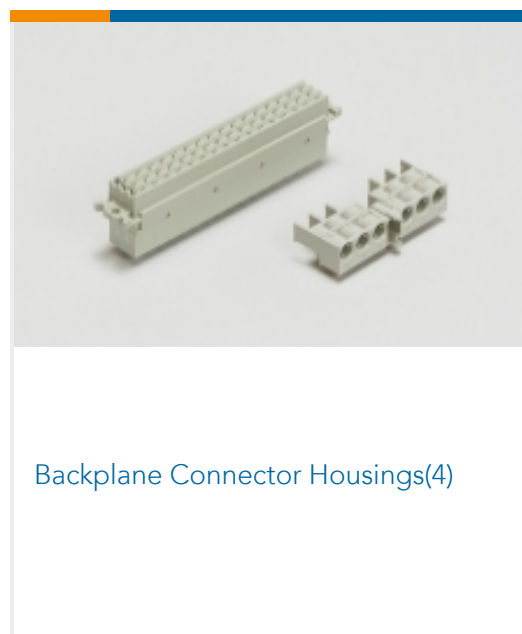



Rectangular Power Connectors(87)

Customers Also Bought



TE Part #DT04-2P
REC, 2P, GRY, N



TE Part #DT06-2S
PLG, 2P, GRY, N



TE Part #W2S
Wedgelocks: DEUTSCH DT



TE Part #0462-201-16141
DEUTSCH Solid Contacts



TE Part #282104-1
AMP SUPERSEAL 1.5MM,
CONNECTOR HOUSING

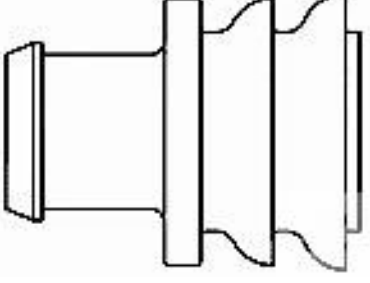

TE Part #281934-2
SINGLE WIRE SEAL

Documents

Product Drawings

2MM HM ASY,T-D HDR,10R,220,AP

English

CAD Files

Customer View Model

[ENG_CVM_CVM_3-646356-0_H.2d_dxf.zip](#)

English

3D PDF

3D

Customer View Model

[ENG_CVM_CVM_3-646356-0_H.3d_igs.zip](#)

English

Customer View Model

[ENG_CVM_CVM_3-646356-0_H.3d_stp.zip](#)

English

By downloading the CAD file I accept and agree to the [Terms and Conditions](#) of use.



[Product Specifications](#)

[Application Specification](#)

English