



M12 Connector

TE Internal #: 3-2172096-2

TE Internal Description: M12 MALE CABLE CONNECTOR-T-CODING-SHLD

[View on TE.com >](#)

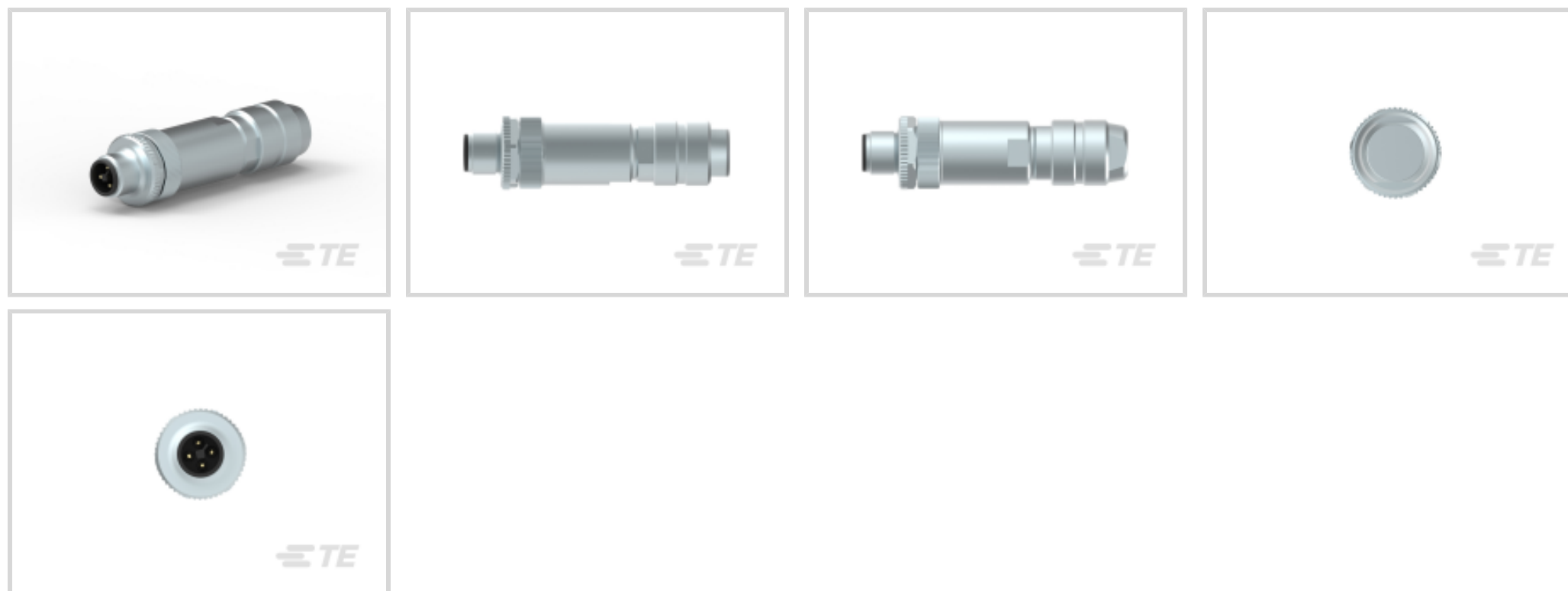

Product Compliance

[For compliance documentation, visit the product page on TE.com>](#)

EU RoHS Directive 2011/65/EU	Compliant with Exemptions
EU ELV Directive 2000/53/EC	Compliant with Exemptions
China RoHS 2 Directive MIIT Order No 32, 2016	Restricted Materials Above Threshold
EU REACH Regulation (EC) No. 1907/2006	Current ECHA Candidate List: JUNE 2023 (235) Candidate List Declared Against: JAN 2023 (233) SVHC > Threshold: Pb (3% in Component Part) Article Safe Usage Statements: Do not eat, drink or smoke when using this product. Wash thoroughly after handling. Recycle if possible and dispose of the article by following all applicable governmental regulations relevant to your geographic location.
Halogen Content	Low Halogen - Br, Cl, F, I < 900 ppm per homogenous material. Also BFR/CFR/PVC Free
Solder Process Capability	Not reviewed for solder process capability

Product Compliance Disclaimer

This information is provided based on reasonable inquiry of our suppliers and represents our current actual knowledge based on the information they provided. This information is subject to change. The part numbers that TE has identified as EU RoHS compliant have a maximum concentration of 0.1% by weight in homogenous materials for lead, hexavalent chromium, mercury, PBB, PBDE, DBP, BBP, DEHP, DIBP, and 0.01% for cadmium, or qualify for an exemption to these limits as defined in the Annexes of Directive 2011/65/EU (RoHS2). Finished electrical and electronic equipment products will be CE marked as required by Directive 2011/65/EU. Components may not be CE marked. Additionally, the part numbers that TE has identified as EU ELV compliant have a maximum concentration of 0.1% by weight in homogenous materials for lead, hexavalent chromium, and mercury, and 0.01% for cadmium, or qualify for an exemption to these limits as defined in the Annexes of Directive 2000/53/EC (ELV). Regarding the REACH Regulation, the information TE provides on SVHC in articles for this part number is based on the latest European Chemicals Agency (ECHA) 'Guidance on requirements for substances in articles' posted at this URL: <https://echa.europa.eu/guidance-documents/guidance-on-reach>

Compatible Parts



TE Part # 3-2172097-2
M12 FEMALE CABLE CONNECTOR-T-CODING-SHLD

Also in the Series | M12 Connector



Connector Caps & Covers(5)



Connector Hardware(12)



Connector Seals & Cavity Plugs(4)



M8/M12 Cable Assemblies(230)



Standard Circular Connectors(803)

Customers Also Bought



TE Part #2209545-9
94P PLUG ASSY, NORMAL CODING



TE Part #C13218-000
HX-SCE Low Fire Hazard Sleeves



TE Part #F01667-000
WP-191064-10-9



TE Part #5-1703282-1
MQS0,63 Sn rec CB unseal. 0,5-0,75 2P

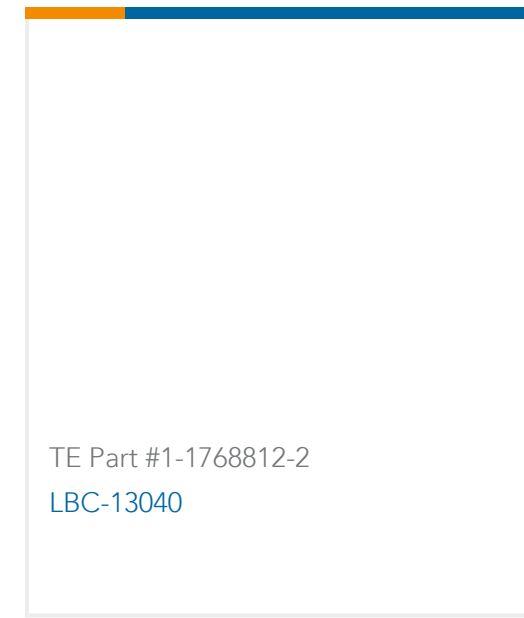
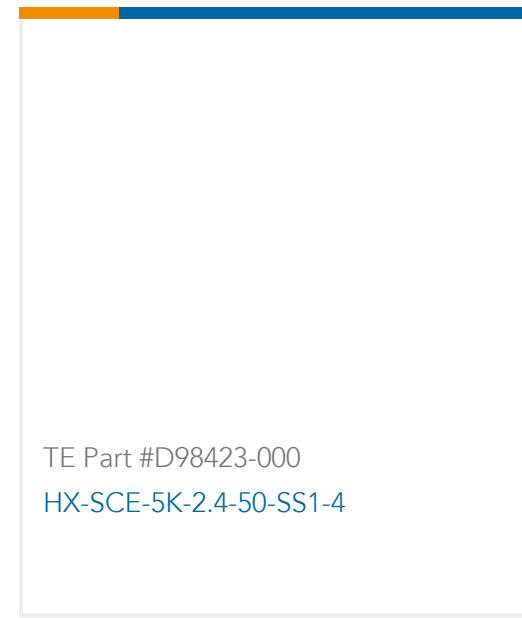
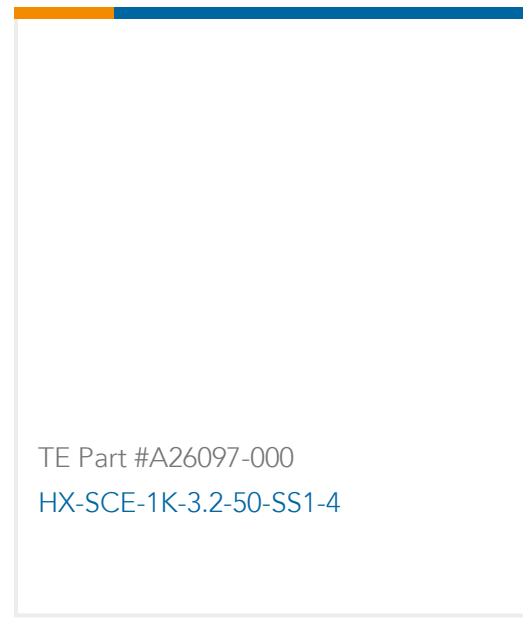

Documents

Datasheets & Catalog Pages

[M8 / M12 Connector System Catalog](#)

Japanese

Product Specifications

[Product Specification](#)

English