

IEC Plug 400 VDC, Rewireable, Straight, max. Cable Diameter 9.2 mm



GP21 rewireable cord plug for 400 VDC systems up to 2.6 kW

Standard Sheet 2



See below:

[Approvals and Compliances](#)

**Description**

- Plug (rewireable) :  
Screw-on mounting
- Plug , Protection class I
- Wire size 0.75-1.5mm<sup>2</sup>, 18AWG-16AWG
- Cable diameter 6.4 - 9.2 mm

**Unique Selling Proposition**

- Standard form acc. to IEC TS 62735-1
- Hot plug rated for disconnecting under loads up to 2.6 kW
- Ideal for compact PDU applications with an operating temperature up to 105 °C

**Weblinks**

[pdf data sheet](#), [html datasheet](#), [General Product Information](#), [Distributor-Stock-Check](#), [Accessories](#), [Mounting instruction](#), [Detailed request for product](#), [Landing Page](#), [Video](#)

**Technical Data**

Ratings IEC	6.5 - 8.8 A / 400 - 294 VDC max. 2.6 kW power
Dielectric Strength	> 3kVDC between + and - > 3kVDC between +/- and PE (1 min)
Allowable Operation Temperature	-5°C to 105°C
Terminal	Screw terminal
Material: Housing	Thermoplastic, black, UL 94V-0

appliance inlet/-outlet	Standard Sheet 2 acc. to IEC TS 62735-1 Protection Class I , ± 200 VDC
-------------------------	---

**Approvals and Compliances**

Detailed information on product approvals, code requirements, usage instructions and detailed test conditions can be looked up in [Details about Approvals](#)

SCHURTER products are designed for use in industrial environments. They have approvals from independent testing bodies according to national and international standards. Products with specific characteristics and requirements such as required in the automotive sector according to IATF 16949, medical technology according to ISO 13485 or in the aerospace industry can be offered exclusively with customer-specific, individual agreements by SCHURTER.

**Approvals**



The approval mark is used by the testing authorities to certify compliance with the safety requirements placed on electronic products.

Approval Reference Type: GP21

Approval Logo	Certificates	Certification Body	Description
	<a href="#">VDE Approvals</a>	VDE	VDE Certificate Number: pending
	<a href="#">UL Approvals</a>	UL	UL File Number: E502317

**Product standards**

Product standards that are referenced

Organization	Design	Standard	Description
	Designed according to	IEC TS 62735-1	Appliance couplers for household and similar general purposes
	Designed according to	UL Subject 2695	Outline for DC rated Attachment Plugs and Outlet Devices for ICT Equipment installed in restricted access locations





**Application standards**

Application standards where the product can be used

Organization	Design	Standard	Description
	Designed for applications acc.	IEC/UL 60950	IEC 60950-1 includes the basic requirements for the safety of information technology equipment.

**Compliances**

The product complies with following Guide Lines

Identification	Details	Initiator	Description
	RoHS	SCHURTER AG	Directive RoHS 2011/65/EU, Amendment (EU) 2015/863
	China RoHS	SCHURTER AG	The law SJ / T 11363-2006 (China RoHS) has been in force since 1 March 2007. It is similar to the EU directive RoHS.
	Halogen Free	SCHURTER AG	SCHURTER strives to offer our customers halogen free products.
	REACH	SCHURTER AG	On 1 June 2007, Regulation (EC) No 1907/2006 on the Registration, Evaluation, Authorization and Restriction of Chemicals 1 (abbreviated as "REACH") entered into force.

**Dimensions [mm]**

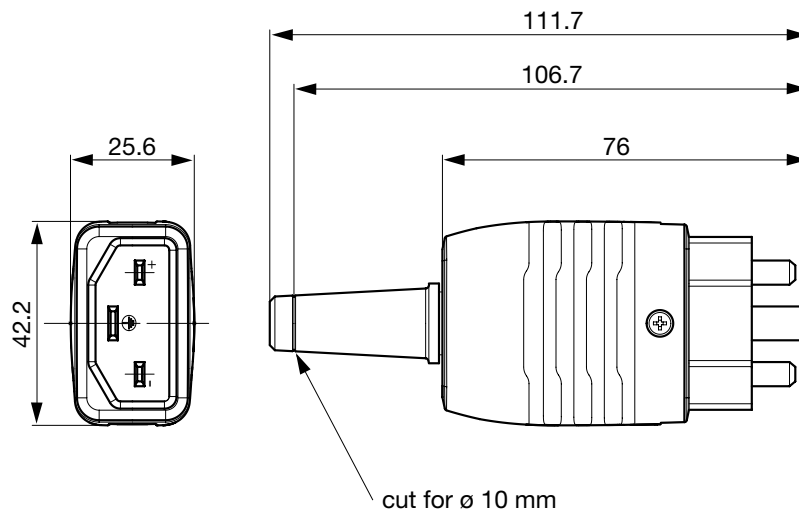

**All Variants**

Color	Max. cable diameter	Max. wire size	Order Number
black	9.2 mm	3 x 1.5 mm <sup>2</sup> / 3 x 16 AWG	3-101-786 

 Most Popular.

Availability for all products can be searched real-time: <https://www.schurter.com/en/Stock-Check/Stock-Check-SCHURTER>

Max. torque for screws: Terminals: 0.5 Nm, Cable clamps: 0.5 Nm, Cover: 0.3 Nm

**Packaging unit** 50 Pcs

## Mating Outlets/Connectors

### Category / Description



[Appliance Outlet Overview complete](#)

IEC Socket-Outlet 400 VDC, Snap-in Mounting, Front Side, Quick-connect or PCB Terminals

GS21

[Appliance Outlet further types to GP21](#)