



SANYO Semiconductors

# DATA SHEET

An ON Semiconductor Company

N-channel Silicon Junction FET

## 2SK596S — Electret Condenser Microphone Applications

### Features

- Low output noise voltage :  $V_{NO} = -110\text{dB max}$  ( $V_{CC} = 4.5\text{V}$ ,  $R_L = 1\text{k}\Omega$ ,  $C_{in} = 15\text{pF}$ ,  $V_{IN} = 0\text{V}$ , A curve)
- Especially suited for use in condenser microphone for audio equipments and telephones
- Excellent transient characteristic
- Adoption of FBET process

### Specifications

Absolute Maximum Ratings at  $T_a = 25^\circ\text{C}$

Parameter	Symbol	Conditions	Ratings	Unit
Gate-to-Drain Voltage	$V_{GDO}$		-20	V
Gate Current	$I_G$		10	mA
Drain Current	$I_D$		1	mA
Allowable Power Dissipation	$P_D$		100	mW
Junction Temperature	$T_J$		150	$^\circ\text{C}$
Storage Temperature	$T_{stg}$		-55 to +150	$^\circ\text{C}$

### Package Dimensions

unit : mm (typ)

7524-005

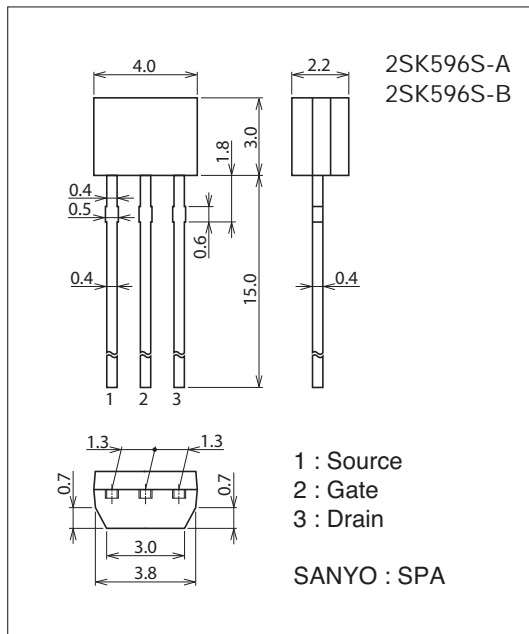

### Product & Package Information

- Package : SPA
- JEITA, JEDEC : SC-72
- Minimum Packing Quantity : 500 pcs./bag

### Marking

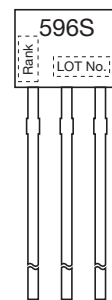

### Electrical Connection

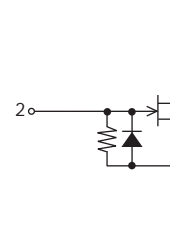

# 2SK596S

## Electrical Characteristics at Ta=25°C

Parameter	Symbol	Conditions	Ratings			Unit	
			Rank	min	typ		max
Gate-to-Drain Breakdown Voltage	V(BR)GDO	I <sub>G</sub> =-100μA		-20		V	
Cutoff Voltage	V <sub>GS(off)</sub>	V <sub>DS</sub> =5V, I <sub>D</sub> =1μA			-0.4	-1.5	V
Drain Current	I <sub>DSS</sub> *	V <sub>DS</sub> =5V, V <sub>GS</sub> =0V	A	100		170	μA
			B	150		240	
Forward Transfer Admittance	y <sub>fs</sub>	V <sub>DS</sub> =5V, V <sub>GS</sub> =0V, f=1kHz		0.4	0.8	mS	
Input Capacitance	C <sub>iss</sub>	V <sub>DS</sub> =5V, V <sub>GS</sub> =0V, f=1MHz			4.1	pF	
Reverse Transfer Capacitance	C <sub>rss</sub>	V <sub>DS</sub> =5V, V <sub>GS</sub> =0V, f=1MHz			0.88	pF	
[Ta=25°C, V <sub>CC</sub> =4.5V, R <sub>L</sub> =1kΩ, C <sub>in</sub> =15pF, See specified Test Circuit.]							
Voltage Gain	G <sub>V</sub>	V <sub>IN</sub> =10mV, f=1kHz	A		-5.0		dB
			B		-3.8		
Reduced Voltage Characteristic	ΔG <sub>VV</sub>	V <sub>IN</sub> =10mV, f=1kHz, V <sub>CC</sub> =4.5V → 1.5V	A		-0.84	-1.8	dB
			B		-0.90	-2.0	
Frequency Characteristic	ΔG <sub>vf</sub>	f=1kHz → 110Hz				-1.0	dB
Total Harmonic Distortion	THD	V <sub>IN</sub> =30mV, f=1kHz	A		2.0		%
			B		1.6		
Output Noise Voltage	V <sub>NO</sub>	V <sub>IN</sub> =0V, A curve				-110	dB

\* : The 2SK596S is classified by I<sub>DSS</sub> as follows : (unit : μA)

Rank	A	B
I <sub>DSS</sub>	100 to 170	150 to 240

## Test Circuit

Voltage Gain

Frequency Characteristic

Harmonic Distortion

Reduced Voltage Characteristic

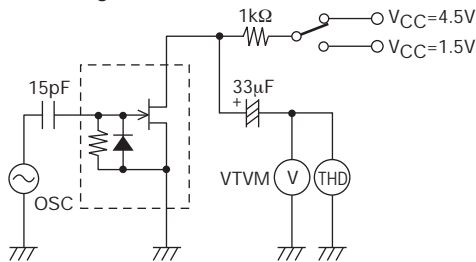

## Ordering Information

Device	Package	Shipping	memo
2SK596S-A	SPA	500pcs./bag	Pb Free
2SK596S-B	SPA	500pcs./bag	

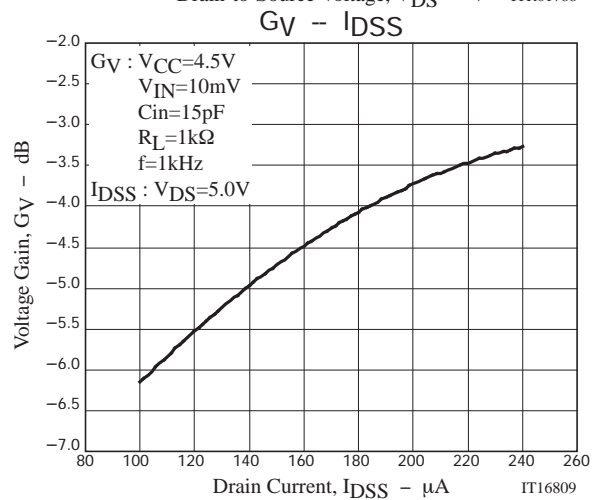
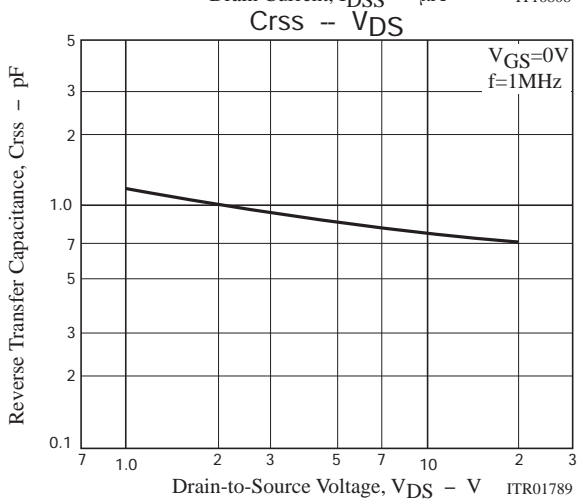
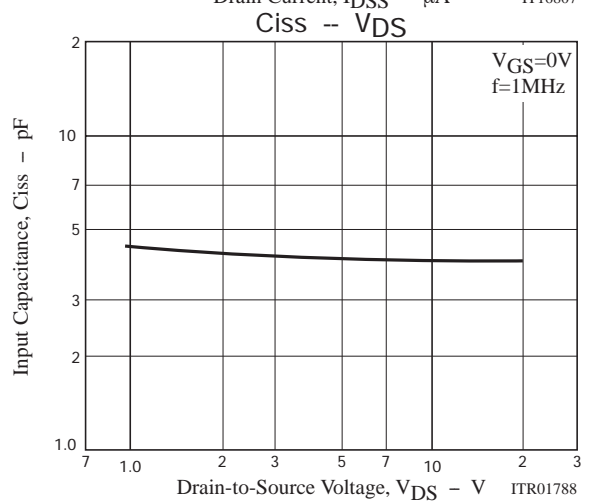
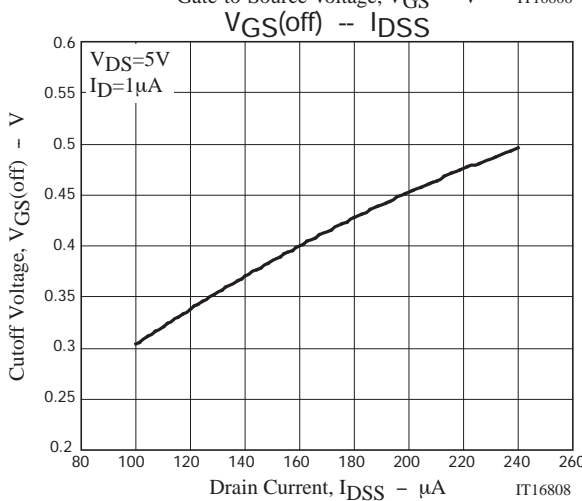
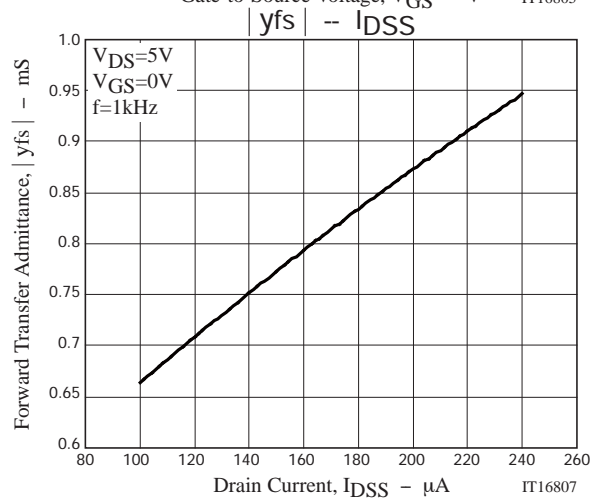
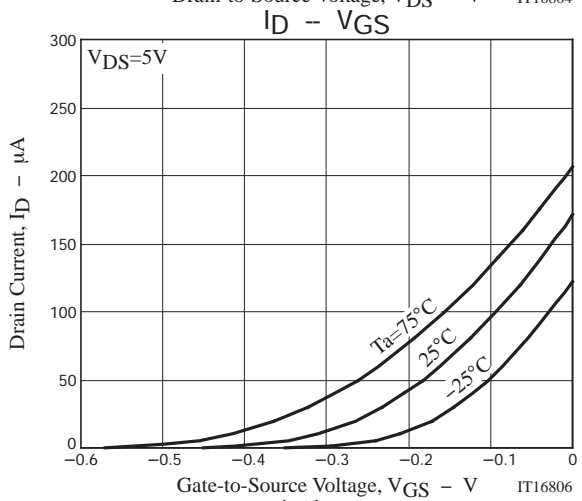
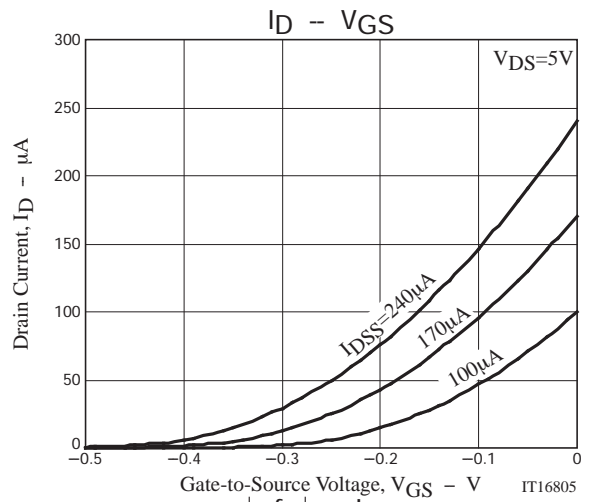
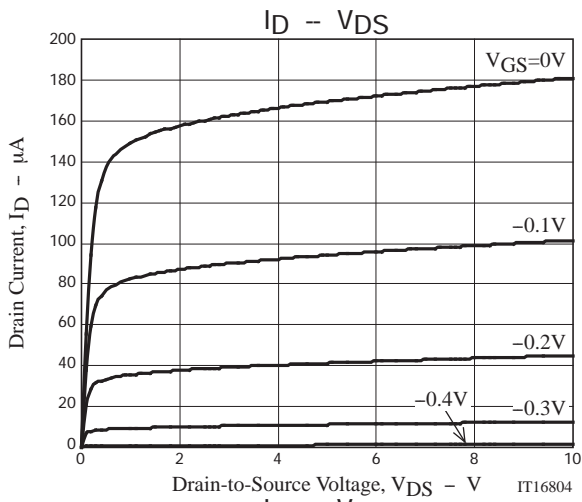

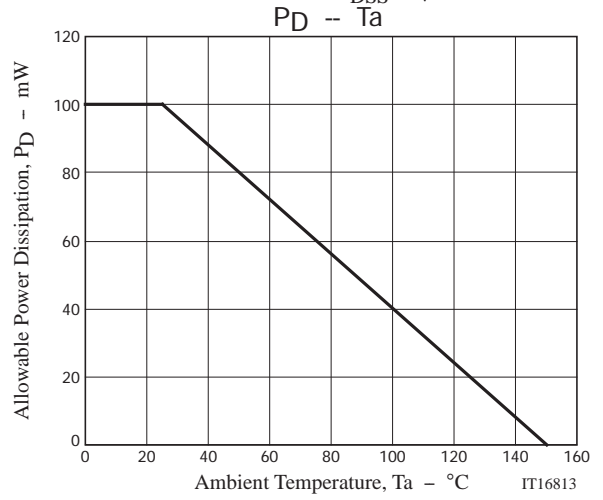
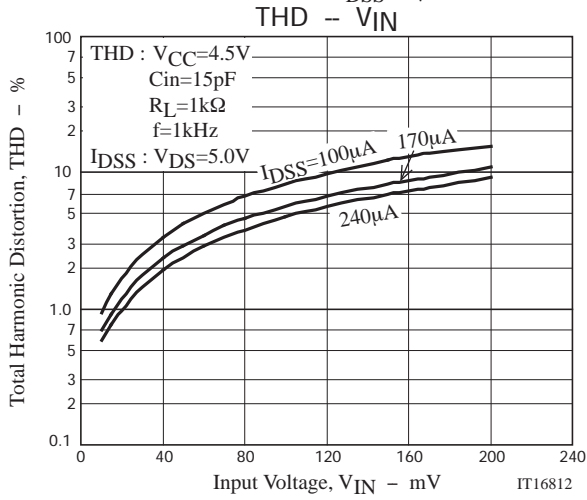
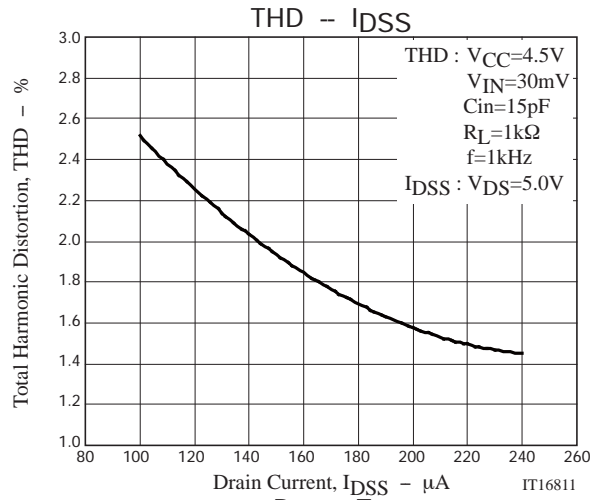
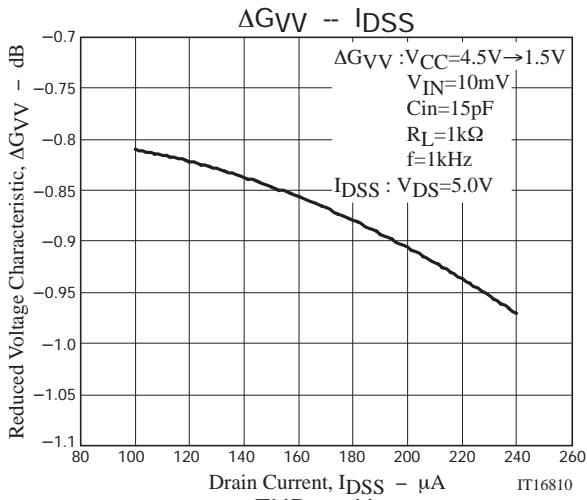

# 2SK596S

## Bag Packing Specification

2SK596S-A, 2SK596S-B

### 1. Packing Format

Package Name	Maximum Number of devices contained (pcs)				
	Bag	Inner BOX		Outer BOX	
SPA	500	B-1	B-1/2	A-1	A-2
		20,000	10,000	100,000	60,000
Packing format (Dimensions:mm (external))					
		Inner BOX		Outer BOX	
		B-1	B-1/2	A-1	A-2
		445×225×55	445×225×55	470×250×300	470×250×190

### 2. Bag dimensions (unit:mm)

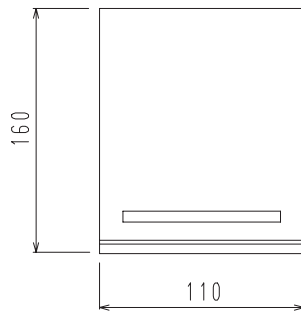

### 3. Bag label, Inner box label (unit:mm)

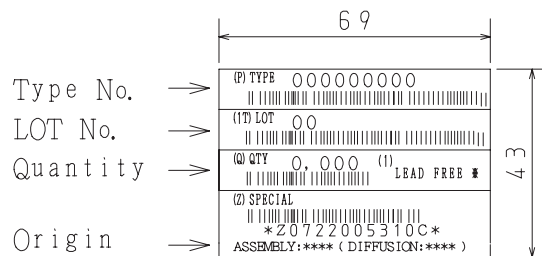

### 4. Outer box label (unit:mm)

It is a label at the time of factory shipments.  
The form of a label may change in physical  
distribution process.

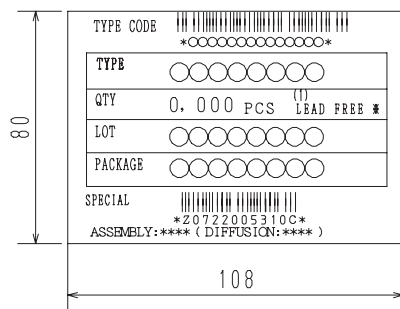

**NOTE (1)**

The LEAD FREE \* description shows that the  
surface treatment of the terminal is lead free.

Label	JEITA Phase
LEAD FREE 3	JEITA Phase 3A
LEAD FREE 4	JEITA Phase 3

# 2SK596S

## Outline Drawing

2SK596S-A, 2SK596S-B

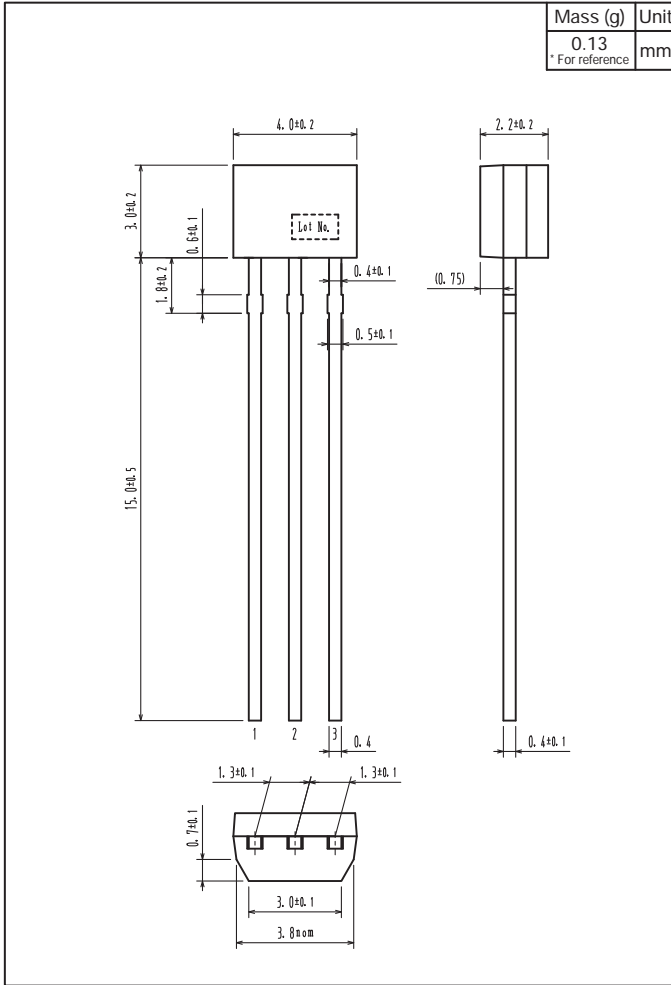

- Any and all SANYO Semiconductor Co.,Ltd. products described or contained herein are, with regard to "standard application", intended for the use as general electronics equipment. The products mentioned herein shall not be intended for use for any "special application" (medical equipment whose purpose is to sustain life, aerospace instrument, nuclear control device, burning appliances, transportation machine, traffic signal system, safety equipment etc.) that shall require extremely high level of reliability and can directly threaten human lives in case of failure or malfunction of the product or may cause harm to human bodies, nor shall they grant any guarantee thereof. If you should intend to use our products for new introduction or other application different from current conditions on the usage of automotive device, communication device, office equipment, industrial equipment etc. , please consult with us about usage condition (temperature, operation time etc.) prior to the intended use. If there is no consultation or inquiry before the intended use, our customer shall be solely responsible for the use.
- Specifications of any and all SANYO Semiconductor Co.,Ltd. products described or contained herein stipulate the performance, characteristics, and functions of the described products in the independent state, and are not guarantees of the performance, characteristics, and functions of the described products as mounted in the customer's products or equipment. To verify symptoms and states that cannot be evaluated in an independent device, the customer should always evaluate and test devices mounted in the customer's products or equipment.
- SANYO Semiconductor Co.,Ltd. assumes no responsibility for equipment failures that result from using products at values that exceed, even momentarily, rated values (such as maximum ratings, operating condition ranges, or other parameters) listed in products specifications of any and all SANYO Semiconductor Co.,Ltd. products described or contained herein.
- SANYO Semiconductor Co.,Ltd. strives to supply high-quality high-reliability products, however, any and all semiconductor products fail or malfunction with some probability. It is possible that these probabilistic failures or malfunction could give rise to accidents or events that could endanger human lives, trouble that could give rise to smoke or fire, or accidents that could cause damage to other property. When designing equipment, adopt safety measures so that these kinds of accidents or events cannot occur. Such measures include but are not limited to protective circuits and error prevention circuits for safe design, redundant design, and structural design.
- In the event that any or all SANYO Semiconductor Co.,Ltd. products described or contained herein are controlled under any of applicable local export control laws and regulations, such products may require the export license from the authorities concerned in accordance with the above law.
- No part of this publication may be reproduced or transmitted in any form or by any means, electronic or mechanical, including photocopying and recording, or any information storage or retrieval system, or otherwise, without the prior written consent of SANYO Semiconductor Co.,Ltd.
- Any and all information described or contained herein are subject to change without notice due to product/technology improvement, etc. When designing equipment, refer to the "Delivery Specification" for the SANYO Semiconductor Co.,Ltd. product that you intend to use.
- Upon using the technical information or products described herein, neither warranty nor license shall be granted with regard to intellectual property rights or any other rights of SANYO Semiconductor Co.,Ltd. or any third party. SANYO Semiconductor Co.,Ltd. shall not be liable for any claim or suits with regard to a third party's intellectual property rights which has resulted from the use of the technical information and products mentioned above.

This catalog provides information as of May, 2012. Specifications and information herein are subject to change without notice.