

293010-4 ✓ ACTIVE

RAST | RAST 5 IDC Connectors

TE Internal #: 293010-4

Housing, Plug, Wire-to-Panel, 5 Position, .196 in [5 mm] Centerline, Crimp, 1 Row, Natural, Wire & Cable, Power & Signal, RAST 5 IDC Connectors

[View on TE.com >](#)



Connectors > PCB Connectors > Wire-to-Board Connectors > Wire-to-Board Connector Assemblies & Housings

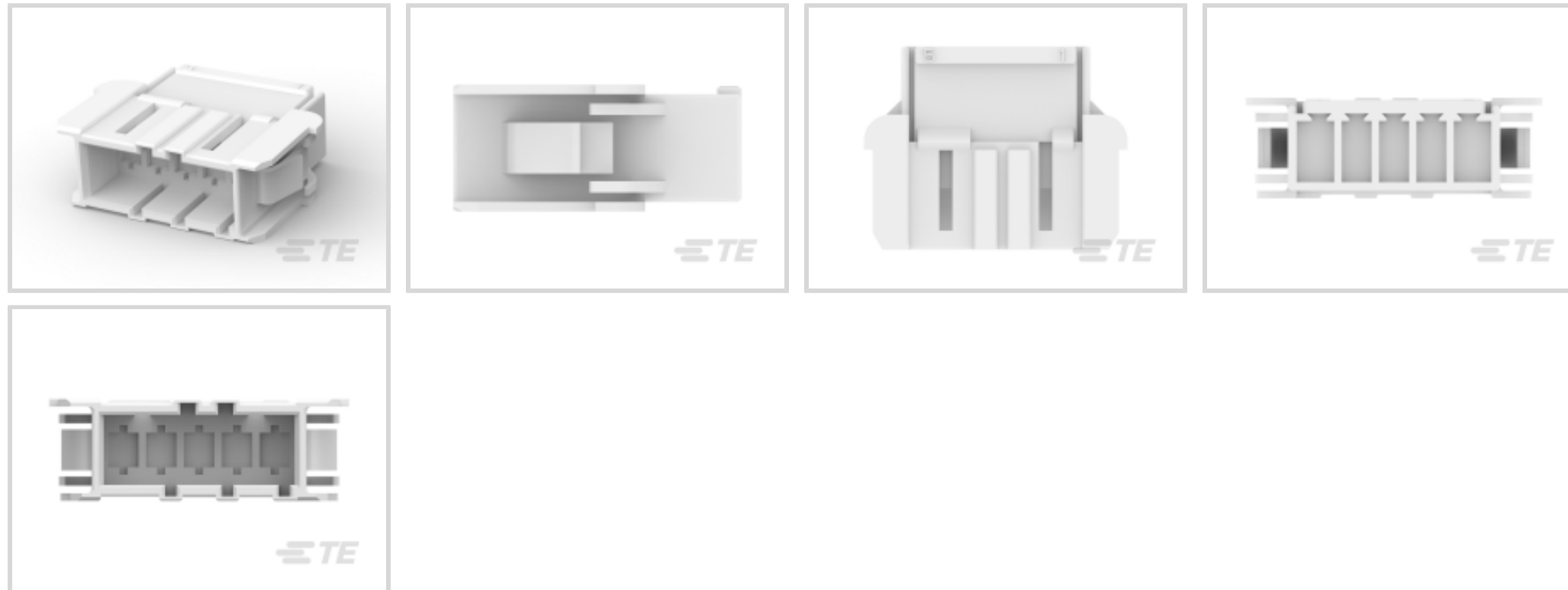

Connector Product Type: **Housing**

Connector & Housing Type: **Plug**

Connector System: **Wire-to-Panel**

Number of Positions: **5**

Centerline (Pitch): **5 mm [.196 in]**

Features

Product Type Features

Connector Product Type	Housing
Connector & Housing Type	Plug
Connector System	Wire-to-Panel
Sealable	No
Connector & Contact Terminates To	Wire & Cable

Configuration Features

Number of Positions	5
Number of Rows	1

Body Features

Primary Product Color	Natural
-----------------------	---------

Contact Features

Contact Layout	Inline
Contact Type	Tab



Termination Features

Termination Method to Wire & Cable	Crimp
------------------------------------	-------

Mechanical Attachment

Panel Mount Feature	With
Panel Mount Feature Type	Latches
Mating Retention	Without
Connector Mounting Type	Panel Mount

Housing Features

Housing Material	PA 66
Centerline (Pitch)	5 mm [.196 in]

Usage Conditions

Operating Temperature Range	-25 – 105 °C [-13 – 221 °F]
-----------------------------	-----------------------------

Operation/Application

Circuit Application	Power & Signal
---------------------	----------------

Product Compliance

[For compliance documentation, visit the product page on TE.com>](#)

EU RoHS Directive 2011/65/EU	Compliant
EU ELV Directive 2000/53/EC	Compliant
China RoHS 2 Directive MIIT Order No 32, 2016	No Restricted Materials Above Threshold
EU REACH Regulation (EC) No. 1907/2006	Current ECHA Candidate List: JUNE 2024 (241) Candidate List Declared Against: JUNE 2024 (241) Does not contain REACH SVHC
Halogen Content	Not Low Halogen - contains Br or Cl > 900 ppm.
Solder Process Capability	Not applicable for solder process capability

Product Compliance Disclaimer

This information is provided based on reasonable inquiry of our suppliers and represents our current actual knowledge based on the information they provided. This information is subject to change. The part numbers that TE has identified as EU RoHS compliant have a maximum concentration of 0.1% by weight in homogenous materials for lead, hexavalent chromium, mercury, PBB, PBDE, DBP, BBP, DEHP, DIBP, and 0.01% for cadmium, or qualify for an exemption to these limits as defined in the Annexes of Directive 2011/65/EU (RoHS2). Finished electrical and electronic equipment products will be CE marked as required by Directive 2011/65/EU. Components may not be CE marked. Additionally, the part numbers that TE has identified as EU ELV compliant have a maximum concentration of 0.1% by weight in homogenous materials for lead, hexavalent chromium, and mercury, and 0.01% for cadmium, or qualify for an exemption to these limits as defined in the Annexes of Directive 2000/53/EC (ELV). Regarding the REACH Regulation, the information TE provides

on SVHC in articles for this part number is based on the latest European Chemicals Agency (ECHA) 'Guidance on requirements for substances in articles' posted at this URL: <https://echa.europa.eu/guidance-documents/guidance-on-reach>

Compatible Parts



TE Part # 293008-1
3 POS. FASTIN-FASTON CONN. TAB HOUSING R



TE Part # 293009-1
4 POS. FASTIN-FASTON CONN. TAB HOUSING R



TE Part # 293014-1
7 POS. FASTIN FASTON TAB HSG



TE Part # 8-927742-2
2POS FASTIN FASTON HOUSING



TE Part # 1-1241968-5
FASTIN FASTON HOUSING 10P



TE Part # 1-293008-1
3 POS. FASTIN-FASTON CONN. TAB HOUSING R



TE Part # 293008-5
3 POS. FASTIN-FASTON CONN. TAB HOUSING R



TE Part # 3-928247-5
5P ST-TIMER GEH



TE Part # 8-927742-6
6 POS FASTIN/ON HOUSING PANEL MOUNT



TE Part # 928344-5
5POS STD TIM HOUSING W. INTERIOR LOCKING



TE Part # 1-928230-2
2 POS FASTIN/ON HOUSING PANEL MOUNT

TE Part # 1-293008-2
3 POS. FASTIN-FASTON CONN. TAB HOUSING R

Also in the Series | RAST 5 IDC Connectors



Automotive Terminals(8)



Connector Contacts(14)



Crimp Terminal Housings(39)



Insertion & Extraction Tools(1)



PCB Headers & Receptacles(417)



Rectangular Connector Housings(1)

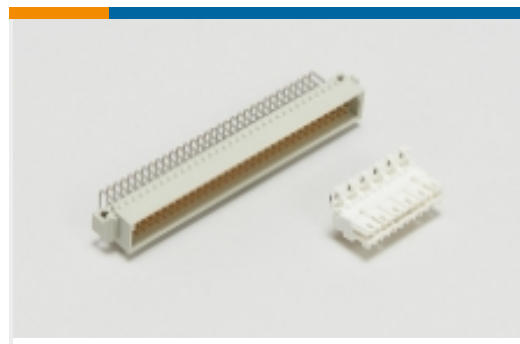

Standard Edge Connectors(33)

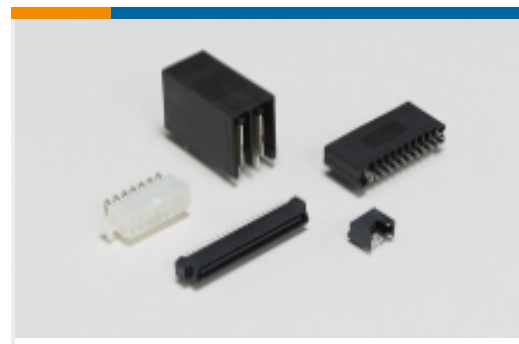

Standard Rectangular Connectors(63)



Wire-to-Board Connector Assemblies & Housings(210)

Customers Also Bought

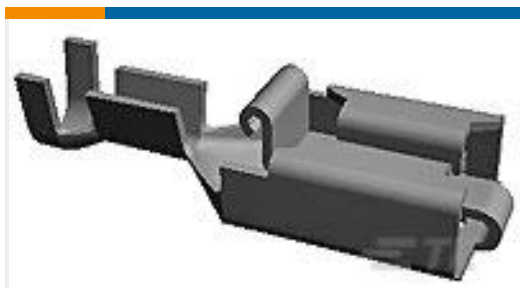

TE Part #160759-3
250 PL MKI REC. 20-15AWG TPBR



TE Part #1534131-1
MQS LOCKING DEVICE FOR4P

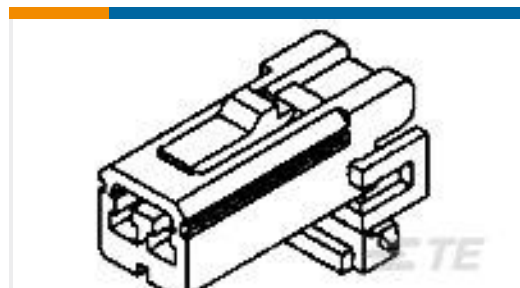

TE Part #174463-1
070 MULTILOCK 2P P

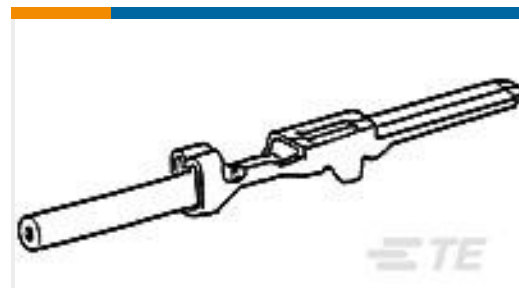

TE Part #173645-1
070 TAB CONT 16-20



TE Part #927771-3
JPT REC 2.8 Contact SRC Sn



TE Part #1-1670988-1
4POS MQS REC COD A

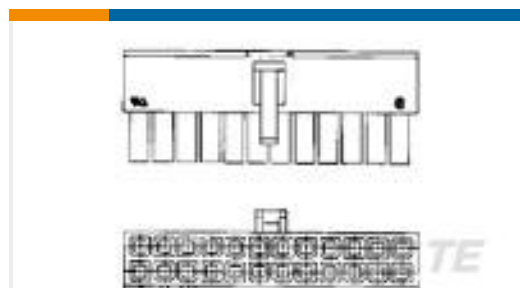

TE Part #1-1586765-0
10P RCPT VAL-U-LOK GW

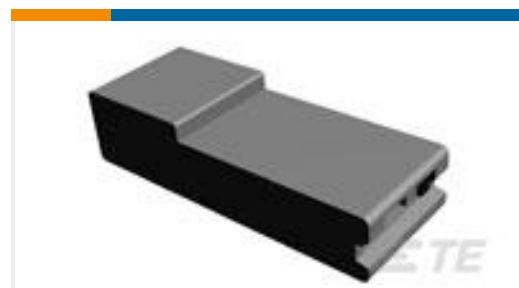

TE Part #1-926539-7
250 FASTON HSG.,REC.,1 POS,BLACK



TE Part #1534072-2
MULTIF.ASSY MK2 2POS,AR

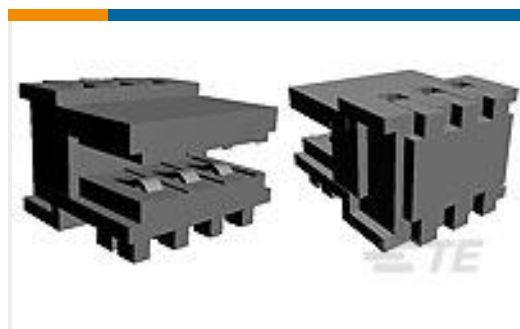

TE Part #3-829868-3
16X 3P FEDERLEI 2,5

Documents



Product Drawings

5 POS. FASTIN-FASTON CONN. TAB HOUSING R

English

CAD Files

3D PDF

3D

Customer View Model

ENG_CVM_CVM_293010-4_C.2d_dxf.zip

English

Customer View Model

ENG_CVM_CVM_293010-4_C.3d_igs.zip

English

Customer View Model

ENG_CVM_CVM_293010-4_C.3d_stp.zip

English

By downloading the CAD file I accept and agree to the [Terms and Conditions](#) of use.

Datasheets & Catalog Pages

RAST Connector System Catalog

English

Product Specifications

Product Specification

English

Agency Approvals

VDE Certificate

English