

# Relay Module - RIF-2-RPT-LV-230AC/4X21/EX



2909739

<https://www.phoenixcontact.com/us/products/2909739>

Please be informed that the data shown in this PDF document is generated from our Online Catalog. Please find the complete data in the user documentation. Our General Terms of Use for Downloads are valid.

---



Pre-assembled relay module consisting of: relay base, function plug-in module, power contact relay, and retaining bracket, approval in accordance with ATEX/IECEX (Zone 2) and Ex Zone Class I, Div. 2, Push-in connection, 4 changeover contacts, Varistor, Input voltage: 230 V AC

---

## Product Description

The pluggable electromechanical and solid-state relays in the RIFLINE complete product range and the base are recognized and approved in accordance with UL 508. The relevant approvals can be called up at the individual components in question.

# Relay Module - RIF-2-RPT-LV-230AC/4X21/EX



2909739

<https://www.phoenixcontact.com/us/products/2909739>

## Commercial Data

Item number	2909739
Packing unit	1 pc
Minimum order quantity	1 pc
Sales Key	C05
Product Key	CK652A
Catalog Page	Page 344 (C-5-2019)
GTIN	4055626379692
Weight per Piece (including packing)	108.3 g
Weight per Piece (excluding packing)	108.3 g
Customs tariff number	85364900
Country of origin	CN

## Technical Data

### Notes

#### Utilization restriction

EMC note	EMC: class A product, see manufacturer's declaration in the download area
----------	---

### Product properties

Product type	Relay Module
Application	Class I, Division 2
Operating mode	100% operating factor
Mechanical service life	approx. $2 \times 10^7$ cycles

#### Insulation characteristics

Overvoltage category	III
	II (Zone 2)
Pollution degree	2
Insulation	Basic insulation

### Electrical properties

Maximum power dissipation for nominal condition	1.5 W
Test voltage	2.5 kV <sub>rms</sub> (50 Hz, 1 min., winding/contact)
Test voltage Contact/contact	2 kV <sub>rms</sub> (50 Hz, 1 min., contact/contact)
Rated insulation voltage	250 V AC
Rated surge voltage	2.5 kV

### Input data

#### Coil side

Nominal input voltage $U_N$	230 V AC
Input voltage range	184 V AC ... 276 V AC (20 °C)
Input voltage range in reference to $U_N$	see diagram
Mains frequency	50/60 Hz
Typical input current at $U_N$	6.5 mA
Typical response time	5 ms ... 15 ms
Typical release time range	5 ms ... 20 ms
Coil voltage	230 V AC
Protective circuit	Varistor
Operating voltage display	Yellow LED

### Output data

#### Switching

Contact type	4 changeover contacts
Type of switch contact	Single contact

# Relay Module - RIF-2-RPT-LV-230AC/4X21/EX



2909739

<https://www.phoenixcontact.com/us/products/2909739>

Drive and function	monostable
Contact material	AgNi
Maximum switching voltage	250 V AC/DC
Minimum switching voltage	5 V (At 24 mA)
Limiting continuous current	5 A (see diagram)
Maximum inrush current	16 A (20 ms, N/O contacts)
Min. switching current	5 mA (24 V)
Interrupting rating (ohmic load) max.	120 W (at 24 V DC) 124 W (at 48 V DC) 108 W (at 60 V DC) 52 W (at 110 V DC) 48 W (at 220 V DC) 1250 VA (for 250 V AC)
Switching capacity	2 A (at 24 V, DC13) 0.22 A (at 120 V, DC13) 0.11 A (at 250 V, DC13) 1.5 A (at 24 V, AC15) 1.5 A (at 120 V, AC15) 1 A (at 240 V, AC15)

## Connection data

Connection method	Push-in connection
Stripping length	8 mm
Conductor cross section solid	0.14 mm <sup>2</sup> ... 1.5 mm <sup>2</sup>
Conductor cross section flexible	0.14 mm <sup>2</sup> ... 1.5 mm <sup>2</sup> 0.14 mm <sup>2</sup> ... 1.5 mm <sup>2</sup> (Ferrule with plastic sleeve) 0.14 mm <sup>2</sup> ... 1 mm <sup>2</sup> (Ferrule with plastic sleeve, two conductors on double terminal block)
Conductor cross section AWG	26 ... 16 (solid) 26 ... 16 (flexible)

## Dimensions

Width	31 mm
Height	96 mm
Depth	75 mm
Hole diameter	3.2 mm

## Material specifications

Flammability rating according to UL 94	V2 (Housing)
--	--------------

## Environmental and real-life conditions

### Ambient conditions

Degree of protection	IP20 (Relay base) RT III (Relay)
----------------------	-------------------------------------

# Relay Module - RIF-2-RPT-LV-230AC/4X21/EX



2909739

<https://www.phoenixcontact.com/us/products/2909739>

Ambient temperature (operation)	-40 °C ... 50 °C
Ambient temperature (storage/transport)	-40 °C ... 85 °C

## Approval data

### ATEX

Identification	<input type="checkbox"/> II 3G Ex ec nC IIC T4 Gc
Certificate	IBExU17ATEXB014X

### IECEX

Identification	Ex ec nC IIC T4 Gc
Certificate	IECEX IBE 17.0032X

### UL, USA / Canada

Identification	Class I, Div. 2, Groups A, B, C, D T4
	Class I, Zone 2, Group IIC

### Corrosive gas test

Identification	ISA-S71.04. G3 Harsh Group
	EN 60068-2-60

## Standards and regulations

Standards/regulations	DIN EN 50178
-----------------------	--------------

### Ex zone

Standards/regulations	EN/IEC 60079-0
	EN/IEC 60079-7
	EN/IEC 60079-15

## Mounting

Mounting type	DIN rail mounting
Assembly instructions	in rows with zero spacing
Mounting position	any

## Drawings

Diagram

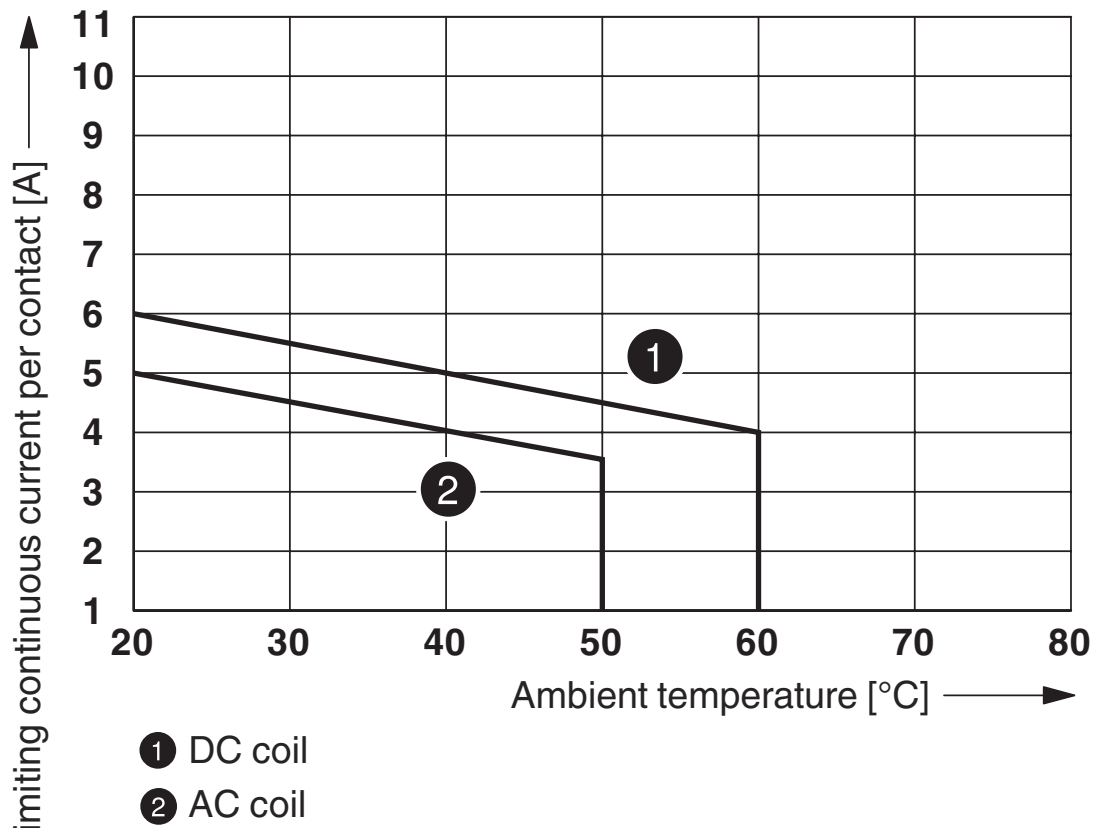

Contact derating

# Relay Module - RIF-2-RPT-LV-230AC/4X21/EX



2909739

<https://www.phoenixcontact.com/us/products/2909739>

Circuit diagram

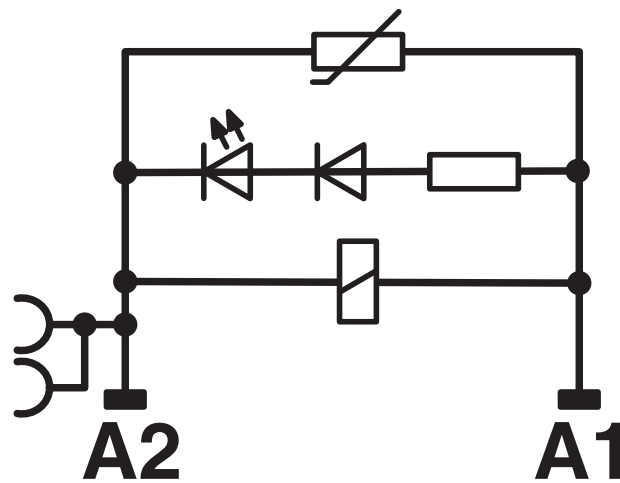
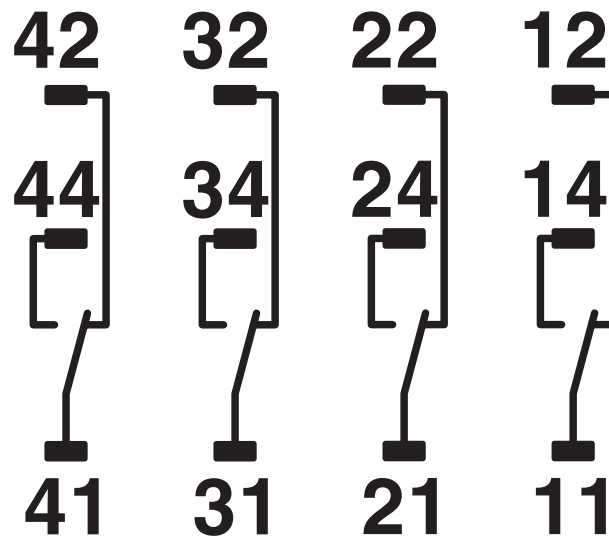

AC coils

Diagram

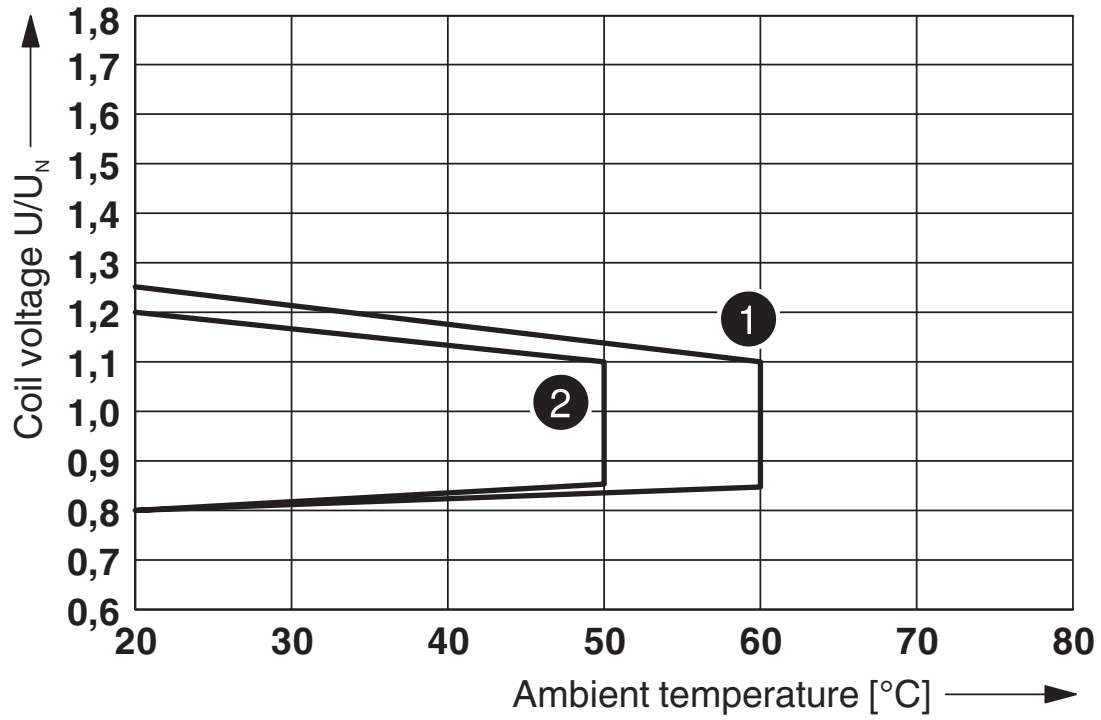

- ① DC coil (observe contact derating)
- ② AC coil (observe contact derating)

Operating voltage range

Diagram

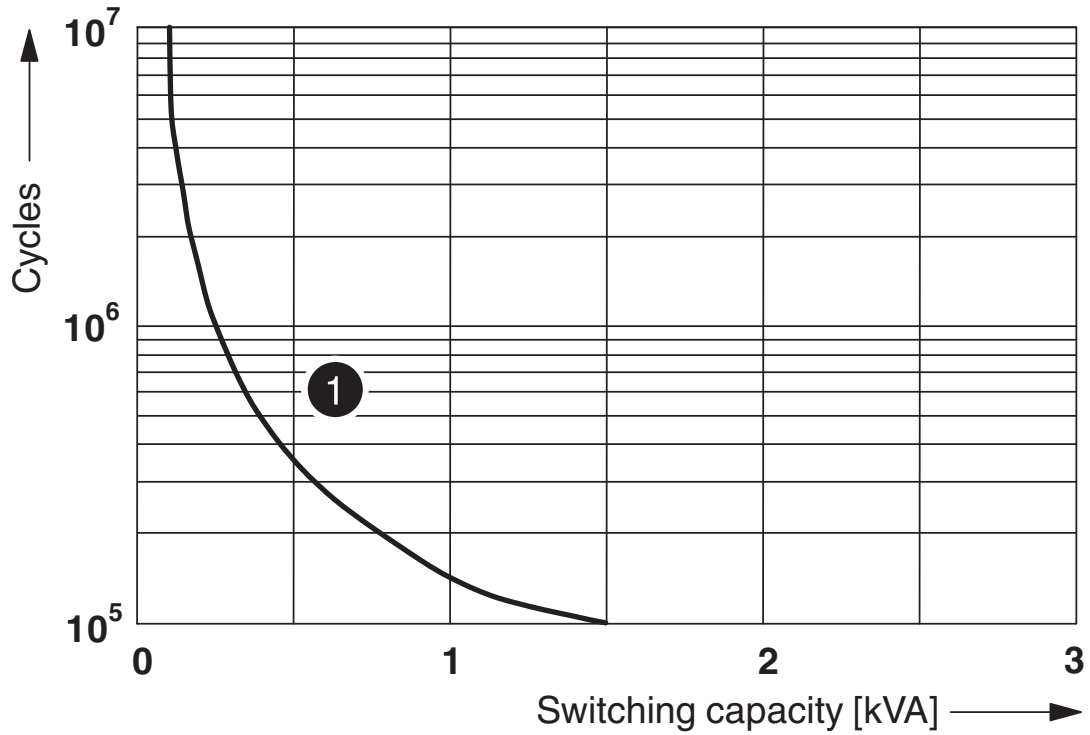

① 250 V AC, Ohmic load

Electrical service life

Diagram

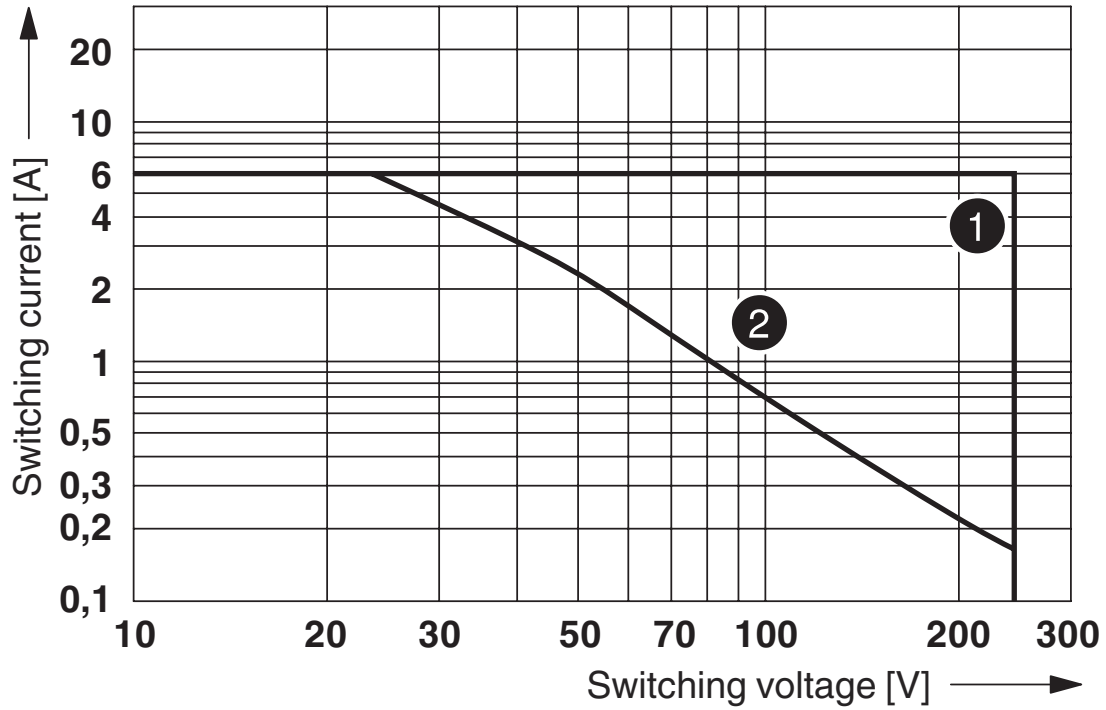

- ① AC, ohmic load
- ② DC, ohmic load

Interrupting rating

Diagram

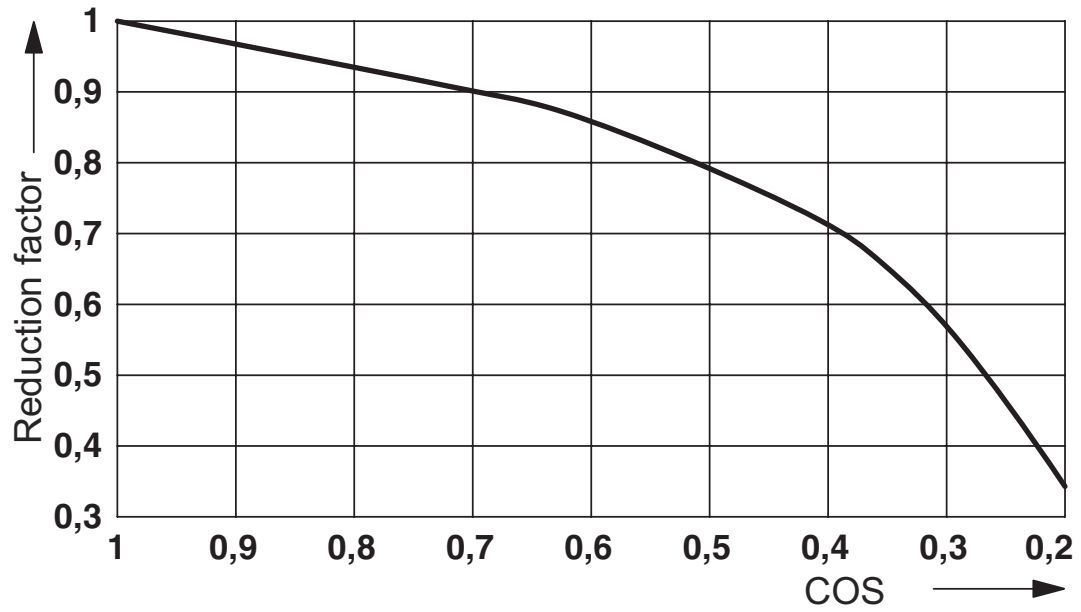

Service life reduction factor

# Relay Module - RIF-2-RPT-LV-230AC/4X21/EX



2909739

<https://www.phoenixcontact.com/us/products/2909739>

## Approvals



**EAC**

Approval ID: TR\_TS\_D\_00573\_c



**EAC**

Approval ID: RU\*C-DE.\*08.B.00010



**UL Listed**

Approval ID: FILE E 238705



**cUL Listed**

Approval ID: FILE E 238705



**IECEx**

Approval ID: IECEx IBE 17.0032X



**cUL Listed**

Approval ID: File E 196811



**UL Listed**

Approval ID: File E 196811



**ATEX**

Approval ID: IBExU 17 ATEX B014 X

**cULus Listed**

**cULus Listed**

# Relay Module - RIF-2-RPT-LV-230AC/4X21/EX



2909739

<https://www.phoenixcontact.com/us/products/2909739>

## Classifications

### ECLASS

ECLASS-9.0	27371601
ECLASS-10.0.1	27371601
ECLASS-11.0	27371601

### ETIM

ETIM 8.0	EC001437
----------	----------

### UNSPSC

UNSPSC 21.0	39122300
-------------	----------

# Relay Module - RIF-2-RPT-LV-230AC/4X21/EX



2909739

<https://www.phoenixcontact.com/us/products/2909739>

## Environmental Product Compliance

China RoHS	Environmentally Friendly Use Period = 50 years For information on hazardous substances, refer to the manufacturer's declaration available under "Downloads"
------------	--

# Relay Module - RIF-2-RPT-LV-230AC/4X21/EX



2909739

<https://www.phoenixcontact.com/us/products/2909739>

## Accessories

### End clamp

End clamp - CLIPFIX 35 - 3022218

<https://www.phoenixcontact.com/us/products/3022218>

Quick mounting end clamp for NS 35/7,5 DIN rail or NS 35/15 DIN rail, with marking option, width: 9.5 mm, color: gray



---

### End clamp

End clamp - CLIPFIX 35-5 - 3022276

<https://www.phoenixcontact.com/us/products/3022276>

Quick mounting end clamp for NS 35/7,5 DIN rail or NS 35/15 DIN rail, with marking option, with parking option for FBS...5, FBS...6, KSS 5, KSS 6, width: 5.15 mm, color: gray



# Relay Module - RIF-2-RPT-LV-230AC/4X21/EX



2909739

<https://www.phoenixcontact.com/us/products/2909739>

## End clamp

End clamp - E/NS 35 N - 0800886

<https://www.phoenixcontact.com/us/products/0800886>

End clamp, width: 9.5 mm, color: gray



---

## Insulating sleeve

Insulating sleeve - MPS-IH WH - 0201663

<https://www.phoenixcontact.com/us/products/0201663>

Insulating sleeve, color: white



# Relay Module - RIF-2-RPT-LV-230AC/4X21/EX

2909739

<https://www.phoenixcontact.com/us/products/2909739>



## Insulating sleeve

Insulating sleeve - MPS-IH RD - 0201676

<https://www.phoenixcontact.com/us/products/0201676>

Insulating sleeve, color: red



---

## Insulating sleeve

Insulating sleeve - MPS-IH BU - 0201689

<https://www.phoenixcontact.com/us/products/0201689>

Insulating sleeve, color: blue



# Relay Module - RIF-2-RPT-LV-230AC/4X21/EX



2909739

<https://www.phoenixcontact.com/us/products/2909739>

## Insulating sleeve

Insulating sleeve - MPS-IH YE - 0201692

<https://www.phoenixcontact.com/us/products/0201692>

Insulating sleeve, color: yellow



---

## Insulating sleeve

Insulating sleeve - MPS-IH GN - 0201702

<https://www.phoenixcontact.com/us/products/0201702>

Insulating sleeve, color: green



# Relay Module - RIF-2-RPT-LV-230AC/4X21/EX



2909739

<https://www.phoenixcontact.com/us/products/2909739>

## Insulating sleeve

Insulating sleeve - MPS-IH GY - 0201728

<https://www.phoenixcontact.com/us/products/0201728>

Insulating sleeve, color: gray



---

## Insulating sleeve

Insulating sleeve - MPS-IH BK - 0201731

<https://www.phoenixcontact.com/us/products/0201731>

Insulating sleeve, color: black



# Relay Module - RIF-2-RPT-LV-230AC/4X21/EX



2909739

<https://www.phoenixcontact.com/us/products/2909739>

## End cap

End cap - NS 35/ 7,5 CAP - 1206560

<https://www.phoenixcontact.com/us/products/1206560>

DIN rail end piece, for DIN rail NS 35/7.5



---

## End cap

End cap - NS 35/15 CAP - 1206573

<https://www.phoenixcontact.com/us/products/1206573>

DIN rail end piece, for DIN rail NS 35/15



# Relay Module - RIF-2-RPT-LV-230AC/4X21/EX



2909739

<https://www.phoenixcontact.com/us/products/2909739>

## DIN rail, unperforated

DIN rail, unperforated - NS 35/ 7,5 UNPERF 2000MM - 0801681

<https://www.phoenixcontact.com/us/products/0801681>



DIN rail, unperforated, acc. to EN 60715, material: Steel, galvanized, passivated with a thick layer, Standard profile, color: silver, Pack of 25 (50 m)

---

## DIN rail, unperforated

DIN rail, unperforated - NS 35/ 7,5 WH UNPERF 2000MM-VPE 10 - 1204122

<https://www.phoenixcontact.com/us/products/1204122>



DIN rail, unperforated, acc. to EN 60715, material: Steel, Galvanized, white passivated, Standard profile, color: silver, Pack of 10 (20 m)

# Relay Module - RIF-2-RPT-LV-230AC/4X21/EX



2909739

<https://www.phoenixcontact.com/us/products/2909739>

## DIN rail, unperforated

DIN rail, unperforated - NS 35/ 7,5 AL UNPERF 2000MM - 0801704

<https://www.phoenixcontact.com/us/products/0801704>



DIN rail, unperforated, acc. to EN 60715, material: Aluminum, uncoated, Standard profile, color: silver, Pack of 25 (50 m)

---

## DIN rail, unperforated

DIN rail, unperforated - NS 35/ 7,5 ZN UNPERF 2000MM - 1206434

<https://www.phoenixcontact.com/us/products/1206434>



DIN rail, unperforated, acc. to EN 60715, material: Steel, galvanized, Standard profile, color: silver, Pack of 25 (50 m)

# Relay Module - RIF-2-RPT-LV-230AC/4X21/EX



2909739

<https://www.phoenixcontact.com/us/products/2909739>

## DIN rail, unperforated

DIN rail, unperforated - NS 35/ 7,5 CU UNPERF 2000MM-VPE 10 - 0801762

<https://www.phoenixcontact.com/us/products/0801762>



DIN rail, unperforated, acc. to EN 60715, material: Copper, uncoated, Standard profile, color: copper-colored, Pack of 10 (20 m)

---

## DIN rail, unperforated

DIN rail, unperforated - NS 35/15 UNPERF 2000MM - 1201714

<https://www.phoenixcontact.com/us/products/1201714>



DIN rail, unperforated, similar to EN 60715, material: Steel, galvanized, passivated with a thick layer, Standard profile, color: silver, Pack of 25 (50 m)

# Relay Module - RIF-2-RPT-LV-230AC/4X21/EX



2909739

<https://www.phoenixcontact.com/us/products/2909739>

## DIN rail, unperforated

DIN rail, unperforated - NS 35/15 WH UNPERF 2000MM-VPE 10 - 1204135

<https://www.phoenixcontact.com/us/products/1204135>



DIN rail, unperforated, similar to EN 60715, material: Steel, Galvanized, white passivated, Standard profile, color: silver, Pack of 10 (20 m)

---

## DIN rail, unperforated

DIN rail, unperforated - NS 35/15 AL UNPERF 2000MM - 1201756

<https://www.phoenixcontact.com/us/products/1201756>



DIN rail, unperforated, similar to EN 60715, material: Aluminum, uncoated, Standard profile, color: silver

# Relay Module - RIF-2-RPT-LV-230AC/4X21/EX



2909739

<https://www.phoenixcontact.com/us/products/2909739>

## DIN rail, unperforated

DIN rail, unperforated - NS 35/15 ZN UNPERF 2000MM - 1206586

<https://www.phoenixcontact.com/us/products/1206586>



DIN rail, unperforated, similar to EN 60715, material: Steel, galvanized, Standard profile, color: silver, Pack of 25 (50 m)

---

## DIN rail, unperforated

DIN rail, unperforated - NS 35/15 CU UNPERF 2000MM-VPE 10 - 1201895

<https://www.phoenixcontact.com/us/products/1201895>



DIN rail, unperforated, similar to EN 60715, material: Copper, uncoated, Standard profile, color: copper-colored, Pack of 10 (20 m)

# Relay Module - RIF-2-RPT-LV-230AC/4X21/EX



2909739

<https://www.phoenixcontact.com/us/products/2909739>

## DIN rail, unperforated

DIN rail, unperforated - NS 35/15-2,3 UNPERF 2000MM-VPE 10 - 1201798

<https://www.phoenixcontact.com/us/products/1201798>



DIN rail, unperforated, acc. to EN 60715, material: Steel, galvanized, passivated with a thick layer, Standard profile 2.3 mm, color: silver, Pack of 10 (20 m)

---

## Plug-in bridge

Plug-in bridge - FBS 2-6 - 3030336

<https://www.phoenixcontact.com/us/products/3030336>



Plug-in bridge, pitch: 6.2 mm, color: red

# Relay Module - RIF-2-RPT-LV-230AC/4X21/EX



2909739

<https://www.phoenixcontact.com/us/products/2909739>

## Plug-in bridge

Plug-in bridge - FBS 2-6 BU - 3036932

<https://www.phoenixcontact.com/us/products/3036932>



Plug-in bridge, pitch: 6.2 mm, color: blue

---

## Plug-in bridge

Plug-in bridge - FBS 2-6 GY - 3032237

<https://www.phoenixcontact.com/us/products/3032237>



Plug-in bridge, pitch: 6.2 mm, color: gray

2909739

<https://www.phoenixcontact.com/us/products/2909739>

## Zack marker strip

Zack marker strip - ZB 5 :UNBEDRUCKT - 1050004

<https://www.phoenixcontact.com/us/products/1050004>



Zack marker strip, Strip, white, unlabeled, can be labeled with: PLOTMARK, CMS-P1-PLOTTER, mounting type: snap in, for terminal block width: 5.2 mm, lettering field size: 5.1 x 10.5 mm, Number of individual labels: 10

---

## Zack marker strip

Zack marker strip - ZB 5 CUS - 0824962

<https://www.phoenixcontact.com/us/products/0824962>



Zack marker strip, can be ordered: Strip, white, labeled according to customer specifications, mounting type: snap into tall marker groove, for terminal block width: 5.2 mm, lettering field size: 5.15 x 10.5 mm, Number of individual labels: 10

# Relay Module - RIF-2-RPT-LV-230AC/4X21/EX



2909739

<https://www.phoenixcontact.com/us/products/2909739>

## Zack marker strip

Zack marker strip - ZB 5,LGS:FORTL.ZAHLEN - 1050017

<https://www.phoenixcontact.com/us/products/1050017>



Zack marker strip, Strip, white, labeled, printed horizontally: consecutive numbers 1 ... 10, 11 ... 20, etc. up to 491 ... 500, mounting type: snap into tall marker groove, for terminal block width: 5.2 mm, lettering field size: 5.15 x 10.5 mm, Number of individual labels: 10

---

## Zack marker strip

Zack marker strip - ZB 5,QR:FORTL.ZAHLEN - 1050020

<https://www.phoenixcontact.com/us/products/1050020>



Zack marker strip, white, Printed vertically: consecutive numbers 1 ... 10, 11 ... 20, etc. up to 491 ... 500, mounting type: snap into tall marker groove, for terminal block width: 5.2 mm, lettering field size: 5.15 x 10.5 mm

# Relay Module - RIF-2-RPT-LV-230AC/4X21/EX



2909739

<https://www.phoenixcontact.com/us/products/2909739>

## Zack marker strip

Zack marker strip - ZB 5,LGS:GLEICHE ZAHLEN - 1050033

<https://www.phoenixcontact.com/us/products/1050033>



Zack marker strip, Strip, white, labeled, can be labeled with: CMS-P1-PLOTTER, printed horizontally: Identical numbers 1 or 2, etc. up to 100, mounting type: snap into tall marker groove, for terminal block width: 5.2 mm, lettering field size: 5.15 x 10.5 mm, Number of individual labels: 10

---

## Zack marker strip

Zack marker strip - ZB 5,LGS:L1-N,PE - 1050415

<https://www.phoenixcontact.com/us/products/1050415>



Zack marker strip, Strip, white, labeled, horizontal: L1, L2, L3, N, PE, L1, L2, L3, N, PE, mounting type: snap into tall marker groove, for terminal block width: 5.2 mm, lettering field size: 5.15 x 10.5 mm, Number of individual labels: 10

2909739

<https://www.phoenixcontact.com/us/products/2909739>

## Zack marker strip

Zack marker strip - ZB 15:UNBEDRUCKT - 0811972

<https://www.phoenixcontact.com/us/products/0811972>



Zack marker strip, Strip, white, unlabeled, can be labeled with: PLOTMARK, CMS-P1-PLOTTER, mounting type: snap in, for terminal block width: 15.2 mm, lettering field size: 10.5 x 15.1 mm, Number of individual labels: 5

---

## Zack marker strip

Zack marker strip - ZB 15 CUS - 0824945

<https://www.phoenixcontact.com/us/products/0824945>



Zack marker strip, can be ordered: Strip, white, labeled according to customer specifications, mounting type: snap into tall marker groove, for terminal block width: 15.2 mm, lettering field size: 10.5 x 15.1 mm, Number of individual labels: 5

# Relay Module - RIF-2-RPT-LV-230AC/4X21/EX



2909739

<https://www.phoenixcontact.com/us/products/2909739>

## Zack marker strip

Zack marker strip - ZB 15,LGS:L1-N,PE - 0811998

<https://www.phoenixcontact.com/us/products/0811998>



Zack marker strip, Strip, white, labeled, printed horizontally: L1, L2, L3, N, PE, mounting type: snap into tall marker groove, for terminal block width: 15.2 mm, lettering field size: 10.5 x 15.1 mm, Number of individual labels: 5

---

## DIN rail perforated

DIN rail perforated - NS 35/ 7,5 PERF 2000MM - 0801733

<https://www.phoenixcontact.com/us/products/0801733>



DIN rail perforated, acc. to EN 60715, material: Steel, galvanized, passivated with a thick layer, Standard profile, color: silver, Pack of 25 (50 m)

# Relay Module - RIF-2-RPT-LV-230AC/4X21/EX



2909739

<https://www.phoenixcontact.com/us/products/2909739>

## DIN rail perforated

DIN rail perforated - NS 35/ 7,5 WH PERF 2000MM - 1204119

<https://www.phoenixcontact.com/us/products/1204119>



DIN rail perforated, acc. to EN 60715, material: Steel, Galvanized, white passivated, Standard profile, color: silver, Pack of 25 (50 m)

---

## DIN rail perforated

DIN rail perforated - NS 35/ 7,5 ZN PERF 2000MM - 1206421

<https://www.phoenixcontact.com/us/products/1206421>



DIN rail perforated, acc. to EN 60715, material: Steel, galvanized, Standard profile, color: silver, Pack of 25 (50 m)

# Relay Module - RIF-2-RPT-LV-230AC/4X21/EX



2909739

<https://www.phoenixcontact.com/us/products/2909739>

## DIN rail perforated

DIN rail perforated - NS 35/15 PERF 2000MM - 1201730

<https://www.phoenixcontact.com/us/products/1201730>



DIN rail perforated, similar to EN 60715, material: Steel, galvanized, passivated with a thick layer, Standard profile, color: silver, Pack of 25 (50 m)

---

## DIN rail perforated

DIN rail perforated - NS 35/15 WH PERF 2000MM - 0806602

<https://www.phoenixcontact.com/us/products/0806602>



DIN rail perforated, similar to EN 60715, material: Steel, Galvanized, white passivated, Standard profile, color: white, Pack of 25 (50 m)

# Relay Module - RIF-2-RPT-LV-230AC/4X21/EX



2909739

<https://www.phoenixcontact.com/us/products/2909739>

## DIN rail perforated

DIN rail perforated - NS 35/15 ZN PERF 2000MM - 1206599

<https://www.phoenixcontact.com/us/products/1206599>



DIN rail perforated, similar to EN 60715, material: Steel, galvanized, Standard profile, color: silver, Pack of 25 (50 m)

---

## Test plugs

Test plugs - MPS-MT - 0201744

<https://www.phoenixcontact.com/us/products/0201744>



Test plugs, with solder connection up to 1 mm<sup>2</sup> conductor cross section, color: gray

# Relay Module - RIF-2-RPT-LV-230AC/4X21/EX



2909739

<https://www.phoenixcontact.com/us/products/2909739>

## Marker for terminal blocks

Marker for terminal blocks - UC-TM 16 - 0819217

<https://www.phoenixcontact.com/us/products/0819217>



Marker for terminal blocks, Sheet, white, unlabeled, can be labeled with: BLUEMARK ID COLOR, BLUEMARK ID, BLUEMARK CLED, PLOTMARK, CMS-P1-PLOTTER, mounting type: snap in, for terminal block width: 16 mm, lettering field size: 15.45 x 10.5 mm, Number of individual labels: 32

---

## Marker for terminal blocks

Marker for terminal blocks - UC-TMF 16 - 0819262

<https://www.phoenixcontact.com/us/products/0819262>



Marker for terminal blocks, Sheet, white, unlabeled, can be labeled with: BLUEMARK ID COLOR, BLUEMARK ID, BLUEMARK CLED, PLOTMARK, CMS-P1-PLOTTER, mounting type: snap in, for terminal block width: 16 mm, lettering field size: 15.45 x 5.1 mm, Number of individual labels: 32

2909739

<https://www.phoenixcontact.com/us/products/2909739>

## Marker for terminal blocks

Marker for terminal blocks - UC-TM 5 - 0818108

<https://www.phoenixcontact.com/us/products/0818108>



Marker for terminal blocks, Sheet, white, unlabeled, can be labeled with: BLUEMARK ID COLOR, BLUEMARK ID, BLUEMARK CLED, PLOTMARK, CMS-P1-PLOTTER, mounting type: snap in, for terminal block width: 5.2 mm, lettering field size: 10.5 x 4.6 mm, Number of individual labels: 96

---

## Marker for terminal blocks

Marker for terminal blocks - UC-TM 5 CUS - 0824581

<https://www.phoenixcontact.com/us/products/0824581>



Marker for terminal blocks, can be ordered: by sheet, white, labeled according to customer specifications, mounting type: snap into tall marker groove, for terminal block width: 5.2 mm, lettering field size: 10.5 x 4.6 mm, Number of individual labels: 96

# Relay Module - RIF-2-RPT-LV-230AC/4X21/EX



2909739

<https://www.phoenixcontact.com/us/products/2909739>

## Marker for terminal blocks

Marker for terminal blocks - UCT-TM 5 - 0828734

<https://www.phoenixcontact.com/us/products/0828734>



Marker for terminal blocks, Sheet, white, unlabeled, can be labeled with: TOPMARK NEO, TOPMARK LASER, BLUEMARK ID COLOR, BLUEMARK ID, BLUEMARK CLED, THERMOMARK PRIME, THERMOMARK CARD 2.0, THERMOMARK CARD, mounting type: snap in, for terminal block width: 5.2 mm, lettering field size: 4.6 x 10.5 mm, Number of individual labels: 72

---

## Marker for terminal blocks

Marker for terminal blocks - UCT-TM 5 CUS - 0829595

<https://www.phoenixcontact.com/us/products/0829595>



Marker for terminal blocks, can be ordered: by sheet, white, labeled according to customer specifications, mounting type: snap into tall marker groove, for terminal block width: 5.2 mm, lettering field size: 4.6 x 10.5 mm, Number of individual labels: 72

# Relay Module - RIF-2-RPT-LV-230AC/4X21/EX



2909739

<https://www.phoenixcontact.com/us/products/2909739>

## Marker carriers

Marker carriers - STP 5-2 - 0800967

<https://www.phoenixcontact.com/us/products/0800967>



Double marker carrier, snaps onto the double-level spring-cage terminal block STTB 2,5, STTB 4, PTTB 2,5, PTTB 4 can be marked with UC-TM 5, ZB 5 or UC-TMF 5, ZBF 5

---

Phoenix Contact 2022 © - all rights reserved

<https://www.phoenixcontact.com>

Phoenix Contact USA  
586 Fulling Mill Road  
Middletown, PA 17057, United States  
(+717) 944-1300  
[info@phoenixcon.com](mailto:info@phoenixcon.com)