

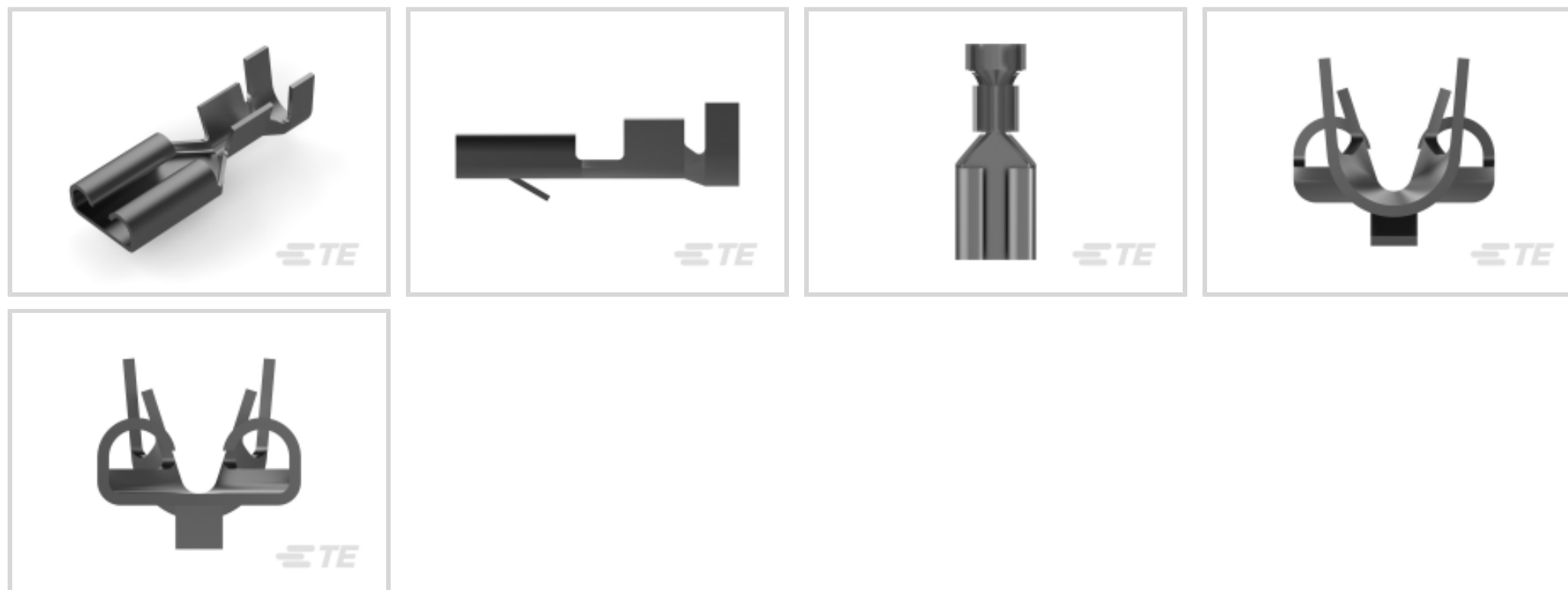

Terminals & Splices > Quick Disconnects



Quick Disconnect Terminal Type: **Receptacle**

Wire Size: .51 – 1.65 mm²

Mating Tab Width: 4.75 mm [.187 in]

Mating Tab Thickness: .81 mm [.032 in]

Features

Product Type Features

Insertion Force	Normal
-----------------	--------

Configuration Features

Connection Capacity	Single
Compatible With Wire & Cable Type	Discrete Wire

Contact Features

Quick Disconnect Terminal Type	Receptacle
Mating Tab Width	4.75 mm [.187 in]
Mating Tab Thickness	.81 mm [.032 in]
Terminal Orientation	Straight
Contact Base Material	Phosphor Bronze
Terminal Plating Material	Pre-Tin
Crimp Type	F-Crimp
Barrel Type	Open

Termination Features

--	--



Product Terminates To	Wire & Cable
-----------------------	--------------

Mechanical Attachment

Extraction Force	4 Newton
Locking Lance Height	1.2 mm
Wire Insulation Support	With
Mating Retention Type	Locking Lance

Dimensions

Terminal Material Thickness	.25 mm[.01 in]
Product Length	16 mm[.629 in]
Compatible Insulation Diameter Range	2.31 – 3.3 mm[.091 – .129 in]
Wire Size	.51 – 1.65 mm ²

Usage Conditions

Insulation Option	Uninsulated
Operating Temperature Range	-40 – 110 °C[-40 – 230 °F]

Packaging Features

Packaging Quantity	8000
Packaging Method	Strip/Reel

Product Compliance

[For compliance documentation, visit the product page on TE.com>](#)

EU RoHS Directive 2011/65/EU	Compliant
EU ELV Directive 2000/53/EC	Compliant
China RoHS 2 Directive MIIT Order No 32, 2016	No Restricted Materials Above Threshold
EU REACH Regulation (EC) No. 1907/2006	Current ECHA Candidate List: JAN 2024 (240) Candidate List Declared Against: JAN 2024 (240) Does not contain REACH SVHC
Halogen Content	Low Halogen - Br, Cl, F, I < 900 ppm per homogenous material. Also BFR/CFR/PVC Free
Solder Process Capability	Not applicable for solder process capability

Product Compliance Disclaimer

This information is provided based on reasonable inquiry of our suppliers and represents our current actual knowledge based on the information they provided. This information is subject to change. The part numbers that TE has identified as



EU RoHS compliant have a maximum concentration of 0.1% by weight in homogenous materials for lead, hexavalent chromium, mercury, PBB, PBDE, DBP, BBP, DEHP, DIBP, and 0.01% for cadmium, or qualify for an exemption to these limits as defined in the Annexes of Directive 2011/65/EU (RoHS2). Finished electrical and electronic equipment products will be CE marked as required by Directive 2011/65/EU. Components may not be CE marked. Additionally, the part numbers that TE has identified as EU ELV compliant have a maximum concentration of 0.1% by weight in homogenous materials for lead, hexavalent chromium, and mercury, and 0.01% for cadmium, or qualify for an exemption to these limits as defined in the Annexes of Directive 2000/53/EC (ELV). Regarding the REACH Regulation, the information TE provides on SVHC in articles for this part number is based on the latest European Chemicals Agency (ECHA) 'Guidance on requirements for substances in articles' posted at this URL: <https://echa.europa.eu/guidance-documents/guidance-on-reach>

Compatible Parts



TE Part # 2150309-1
OCEAN_2.0_APPLICATOR-E-090F130F-REM



TE Part # 2150309-2
OCEAN_2.0_APPLICATOR-E-090F130F-REA



TE Part # 281197-5
FF 187 REC 1.0-2.5MM2 PTBR (RE REELING)



TE Part # 281197-6
FF 187 REC 1.0-2.5MM2 PTBR



KIT
REPRESENTATION ONLY

TE Part # 7-2150309-7
OCEAN_2.0_SPARE_PART_KIT-090F130F



TE Part # 7-2150309-2
OCEAN_2.0_APPLICATOR-E-090F130F

Also in the Series | FASTIN-FASTON 187

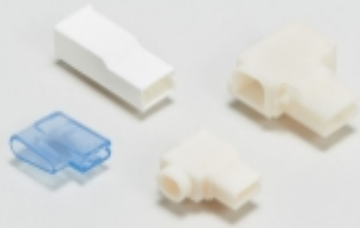

Crimp Terminal Housings(6)



Insertion & Extraction Tools(1)



Quick Disconnects(20)

Customers Also Bought

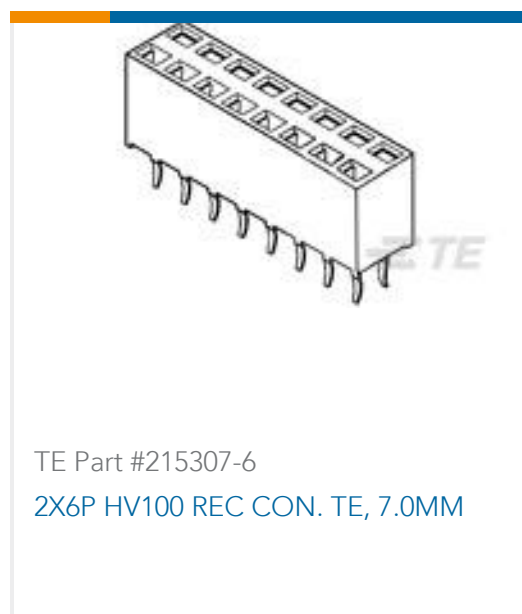

TE Part #215307-6
2X6P HV100 REC CON. TE, 7.0MM



TE Part #42282-1
FF 250 REC 18-14AWG BR LP



TE Part #2-521055-2
ULTRAFast 250 ASSY TAB 22-18
AWG TPBR



TE Part #CZ2554-000
SCT-NO.5-Z4-0-50MM



TE Part #6-1419137-4
V23074A2001A403-EV-CBOX



TE Part #T4144015081-000
M12 RA PCB CONN. Male 8 P UN
SHIELD

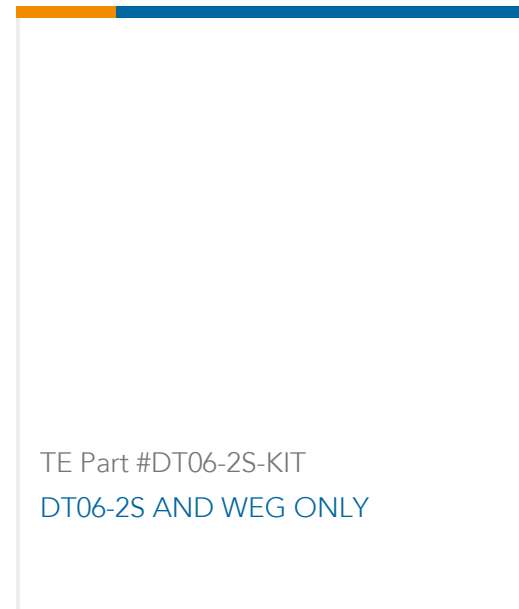

TE Part #DT06-2S-KIT
DT06-2S AND WEG ONLY

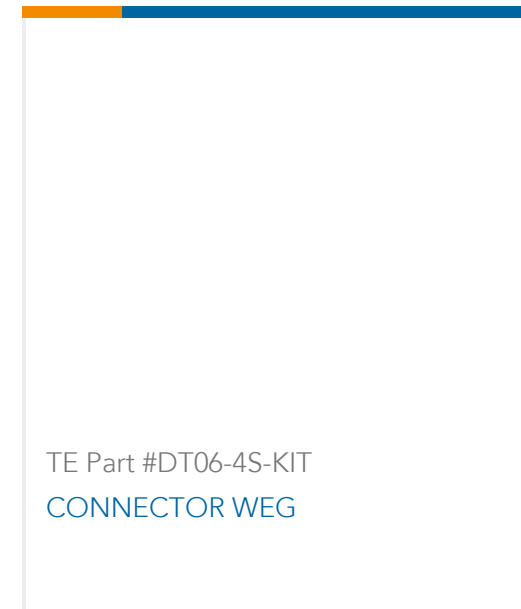

TE Part #DT06-4S-KIT
CONNECTOR WEG

Documents

Product Drawings

[FF 187 REC 0.5-1.5MM2 TPPB](#)

English

CAD Files

[3D PDF](#)

3D

Customer View Model

[ENG_CVM_CVM_280919-4_M.2d_dxf.zip](#)

English

Customer View Model

[ENG_CVM_CVM_280919-4_M.3d_igs.zip](#)

English

Customer View Model

[ENG_CVM_CVM_280919-4_M.3d_stp.zip](#)

English

By downloading the CAD file I accept and agree to the [Terms and Conditions](#) of use.

Product Specifications

[Application Specification](#)

[FASTIN-FASTON Connector, .187 rec. etc.](#)