

Data Sheet | Item Number: 280-903

2-conductor through terminal block; 2.5 mm²; center marking; for DIN-rail 35 x 15 and 35 x 7.5; CAGE CLAMP®; 2,50 mm²; red

<https://www.wago.com/280-903>

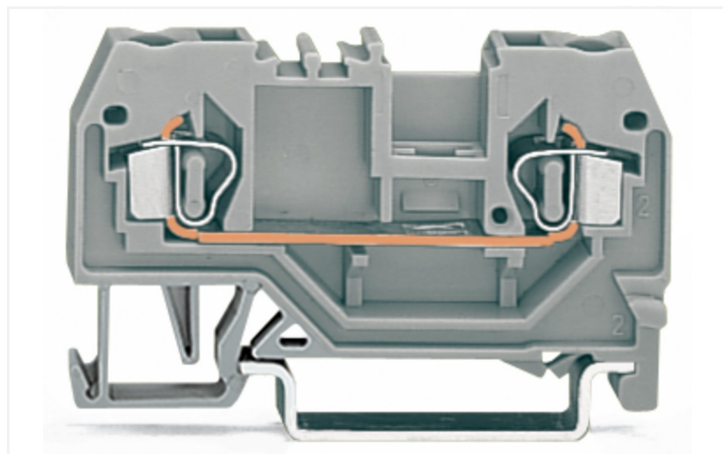

Color: ■ red

Similar to illustration

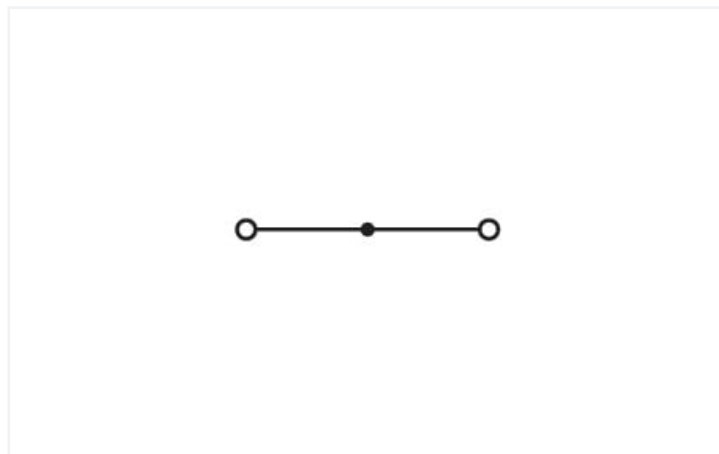

Similar to illustration

Electrical data

Ratings per	IEC/EN 60947-7-1		
Overvoltage category	III	III	II
Pollution degree	3	2	2
Nominal voltage	800 V	-	-
Rated surge voltage	8 kV	-	-
Rated current	24 A	-	-

Approvals per	UL 1059		
Use group	B	C	D
Rated voltage	-	600 V	-
Rated current	-	20 A	-

Approvals per	CSA 22.2 No 158		
Use group	B	C	D
Rated voltage	-	600 V	-
Rated current	-	24 A	-

Power Loss	
Power loss, per pole (potential)	0.7661 W
Rated current I_N for specified power loss	24 A
Resistance value for specified, current-dependent power loss	0.00133 Ω

Connection data

Clamping units	2
Total number of potentials	1
Number of levels	1

Connection 1	
Connection technology	CAGE CLAMP®
Actuation type	Operating tool
Connectable conductor materials	Copper Aluminum

Connection 1

Connectable conductor materials (note)

Terminating Aluminum Conductors

WAGO spring clamp terminal blocks are suitable for solid aluminum conductors up to 4 mm²/12 AWG if WAGO "Alu-Plus" Contact Paste [249-130](#) is used for termination.

"Alu-Plus" Contact Paste Advantages:

- Automatically destroys the oxide film during clamping.
- Prevents fresh oxidation at the clamping point.
- Prevents electrolytic corrosion between aluminum and copper conductors (in the same terminal block).
- Provides long-term protection against corrosion.

Using terminal blocks with CAGE CLAMP® Spring Pressure Connection Technology, **aluminum conductors must first be cleaned with a blade** and then immediately be inserted into the clamping units filled with "Alu-Plus" Contact Paste.

It is also possible to apply WAGO "Alu-Plus" **additionally** on the whole surface of the aluminum conductor before termination.

Please note that the nominal currents must be adapted to the reduced conductivity of the aluminum conductors::

2.5 mm² = 16 A

4 mm² = 22 A

Solid conductor	0.08 ... 2.5 mm ² / 28 ... 12 AWG
Fine-stranded conductor	0.08 ... 2.5 mm ² / 28 ... 12 AWG
Note (conductor cross-section)	12 AWG: THHN, THWN
Strip length	8 ... 9 mm / 0.31 ... 0.35 inches
Wiring direction	Front-entry wiring

Physical data

Width	5 mm / 0.197 inches
Height	53 mm / 2.087 inches
Depth from upper-edge of DIN-rail	28 mm / 1.102 inches

Mechanical data

Mounting type	DIN-35 rail
Marking level	Center marking

Material data

Note (material data)	Information on material specifications can be found here
Color	red
Material group	I
Insulation material (main housing)	Polyamide (PA66)
Flammability class per UL94	V0
Fire load	0.107 MJ
Weight	5.3 g

Environmental requirements

Processing temperature	-35 ... +85 °C
Continuous operating temperature	-60 ... +105 °C

Commercial data

eCl@ss 10.0	27-14-11-20
eCl@ss 9.0	27-14-11-20
ETIM 9.0	EC000897
ETIM 8.0	EC000897
PU (SPU)	100 pcs
Packaging type	Box
Country of origin	PL
GTIN	4044918391832
Customs tariff number	85369010000

Environmental Product Compliance

RoHS Compliance Status	Compliant, No Exemption
------------------------	-------------------------

Approvals / Certificates

General approvals



Approval	Standard	Certificate Name
CCA DEKRA Certification B.V.	EN 60947	2157201.01
CSA DEKRA Certification B.V.	C22.2	1536071
UL Underwriters Laboratories Inc.	UL 1059	E45172

Declarations of conformity and manufacturer's declarations

Approval	Standard	Certificate Name
EU-Declaration of Confor- mity WAGO GmbH & Co. KG	-	-
UK-Declaration of Confor- mity WAGO GmbH & Co. KG	-	-

Approvals for marine applications



Approval	Standard	Certificate Name
ABS American Bureau of Ship- ping	EN 60947	20-HG1941090-PDA
BV Bureau Veritas S.A.	EN 60947	07436/F0 BV
DNV GL Det Norske Veritas, Ger- manischer Lloyd	-	TAE00001V2
LR Lloyds Register	EN 60947	91/20112 (E9)

Downloads

Environmental Product Compliance

Compliance Search	
Environmental Product Compliance 280-903	↓

Documentation

Additional Information		
Technical Section	pdf 2246.92 KB	↓

Bid Text			
280-903	19.02.2019	xml 3.27 KB	↓
280-903	28.02.2017	doc 24.00 KB	↓

CAD/CAE-Data

CAD data	
2D/3D Models 280-903	↓

CAE data	
EPLAN Data Portal 280-903	↓
WSCAD Universe 280-903	↓
ZUKEN Portal 280-903	↓

1 Compatible Products

1.1 Required Accessories

1.1.1 End plate

1.1.1.1 End plate

Item No.: 280-308 End and intermediate plate; 2.5 mm thick; gray	Item No.: 280-309 End and intermediate plate; 2.5 mm thick; orange	Item No.: 280-310 Separator plate; 2 mm thick; oversized; gray	Item No.: 280-311 Separator plate; 2 mm thick; oversized; orange

1.2 Optional Accessories

1.2.1 DIN-rail

1.2.1.1 Mounting accessories

Item No.: 210-196 Aluminum carrier rail; 35 x 8.2 mm; 1.6 mm thick; 2 m long; unslotted; similar to EN 60715; silver-colored	Item No.: 210-198 Copper carrier rail; 35 x 15 mm; 2.3 mm thick; 2 m long; unslotted; according to EN 60715; copper-colored	Item No.: 210-508 Steel carrier rail; 35 x 15 mm; 1.5 mm thick; 2 m long; slotted; galvanized; similar to EN 60715; silver-colored	Item No.: 210-197 Steel carrier rail; 35 x 15 mm; 1.5 mm thick; 2 m long; slotted; similar to EN 60715; silver-colored
Item No.: 210-506 Steel carrier rail; 35 x 15 mm; 1.5 mm thick; 2 m long; unslotted; galvanized; similar to EN 60715; silver-colored	Item No.: 210-114 Steel carrier rail; 35 x 15 mm; 1.5 mm thick; 2 m long; unslotted; similar to EN 60715; silver-colored	Item No.: 210-118 Steel carrier rail; 35 x 15 mm; 2.3 mm thick; 2 m long; unslotted; according to EN 60715; silver-colored	Item No.: 210-115 Steel carrier rail; 35 x 7.5 mm; 1 mm thick; 2 m long; slotted; according to EN 60715; "Hole width 18 mm; silver-colored

1.2.1.1 Mounting accessories



Item No.: 210-112

Steel carrier rail; 35 x 7.5 mm; 1 mm thick; 2 m long; slotted; according to EN 60715; Hole width 25 mm; silver-colored



Item No.: 210-504

Steel carrier rail; 35 x 7.5 mm; 1 mm thick; 2 m long; slotted; galvanized; according to EN 60715; silver-colored



Item No.: 210-113

Steel carrier rail; 35 x 7.5 mm; 1 mm thick; 2 m long; unslotted; according to EN 60715; silver-colored



Item No.: 210-505

Steel carrier rail; 35 x 7.5 mm; 1 mm thick; 2 m long; unslotted; galvanized; according to EN 60715; silver-colored

1.2.2 End plate

1.2.2.1 End plate



Item No.: 284-334

Step-down cover plate; 1 mm thick; for 2-, 3- and 4-conductor terminal blocks; gray



Item No.: 284-344

Step-down cover plate; 1 mm thick; for 2-, 3- and 4-conductor terminal blocks; orange

1.2.3 Ferrule

1.2.3.1 Ferrule



Item No.: 216-301

Ferrule; Sleeve for 0.25 mm² / AWG 24; insulated; electro-tin plated; yellow



Item No.: 216-302

Ferrule; Sleeve for 0.34 mm² / 22 AWG; insulated; electro-tin plated; light turquoise



Item No.: 216-201

Ferrule; Sleeve for 0.5 mm² / 20 AWG; insulated; electro-tin plated; white



Item No.: 216-101

Ferrule; Sleeve for 0.5 mm² / AWG 22; un-insulated; electro-tin plated; silver-colored



Item No.: 216-202

Ferrule; Sleeve for 0.75 mm² / 18 AWG; insulated; electro-tin plated; gray



Item No.: 216-102

Ferrule; Sleeve for 0.75 mm² / AWG 20; un-insulated; electro-tin plated; silver-colored



Item No.: 216-203

Ferrule; Sleeve for 1 mm² / AWG 18; insulated; electro-tin plated; red



Item No.: 216-103

Ferrule; Sleeve for 1 mm² / AWG 18; un-insulated; electro-tin plated



Item No.: 216-204

Ferrule; Sleeve for 1.5 mm² / AWG 16; insulated; electro-tin plated; black



Item No.: 216-104

Ferrule; Sleeve for 1.5 mm² / AWG 16; un-insulated; electro-tin plated; silver-colored

1.2.4 Installation

1.2.4.1 Cover



Item No.: 709-153

Cover; Type 1; suitable for cover carrier, type 1; 1 m long; transparent

1.2.4.2 Cover carrier



Item No.: 709-167

Cover carrier; Type 1; incl. fixing/retaining screws and knurled nut; suitable for 279 to 282 and 880 Series rail-mounted terminal blocks; suitable for 264 Series miniature rail-mounted terminal blocks; suitable for 270 Series sensor and actuator terminal blocks; gray

1.2.4.3 Mounting accessories



Item No.: 209-106

Mounting carrier; for isolated mounting on DIN 35 rails; gray



Item No.: 249-116

Screwless end stop; 6 mm wide; for DIN-rail 35 x 15 and 35 x 7.5; gray

1.2.5 Insulation stop

1.2.5.1 Insulation stop



Item No.: 280-470

Insulation stop; 0.08 - 0.2 mm² "s" (0.14 mm² "f-st"); 5 pieces/strip; white



Item No.: 280-471

Insulation stop; 0.25 - 0.5 mm²; 5 pieces/strip; light gray



Item No.: 280-472

Insulation stop; 0.75 - 1 mm²; 5 pieces/strip; black

1.2.6 Jumper

1.2.6.1 Jumper



Item No.: 280-490

Jumper; 10-way; insulated; gray



Item No.: 280-482

Jumper; 2-way; insulated; gray



Item No.: 280-492

Jumper; 2-way; insulated; gray



Item No.: 280-483

Jumper; 3-way; insulated; gray



Item No.: 280-484

Jumper; 4-way; insulated; gray



Item No.: 280-485

Jumper; 5-way; insulated; gray



Item No.: 280-402

Jumper; insulated; gray



Item No.: 280-409

Jumper; insulated; gray



Item No.: 280-422

Jumper; insulated; yellow-green



Item No.: 780-452

Staggered jumper; from 1 to 2; insulated; gray



Item No.: 780-453

Staggered jumper; from 1 to 3; insulated; gray



Item No.: 780-454

Staggered jumper; from 1 to 4; insulated; gray



Item No.: 780-455

Staggered jumper; from 1 to 5; insulated; gray



Item No.: 780-456

Staggered jumper; from 1 to 6; insulated; gray



Item No.: 780-457

Staggered jumper; from 1 to 7; insulated; gray



Item No.: 780-458

Staggered jumper; from 1 to 8; insulated; gray



Item No.: 284-414

Step-down jumper; from 284/282 to 281/280/279 series; insulated; gray



Item No.: 709-110

Wire commoning chain; 2.5 mm²; insulated; black



Item No.: 709-111

Wire commoning chain; 2.5 mm²; insulated; black



Item No.: 709-112

Wire commoning chain; 2.5 mm²; insulated; black



Item No.: 210-103

Wire commoning chain; insulated; black



Item No.: 210-123

Wire commoning chain; insulated; blue

1.2.7 Marking

1.2.7.1 Double marker carrier



Item No.: 209-128

Adaptor; gray

1.2.7.2 Group marker carrier



Item No.: 209-140

Group marker carrier; gray



Item No.: 209-141

Group marker carrier; gray



Item No.: 209-142

Group marker carrier; gray



Item No.: 249-105

Group marker carrier; gray

1.2.7.3 Marker



Item No.: 793-5501

WMB marking card; as card; for terminal block width 5 - 17.5 mm; stretchable 5 - 5.2 mm; plain; snap-on type; white



Item No.: 793-501

WMB marking card; as card; not stretchable; plain; snap-on type; white



Item No.: 2009-115

WMB-Inline; for Smart Printer; 1500 pieces on roll; stretchable 5 - 5.2 mm; plain; snap-on type; white

1.2.8 Plug

1.2.8.1 Component module with diode



Item No.: 280-803/281-411

Component plug; 2-pole; with diode 1N4007; 10 mm wide; gray



Item No.: 280-803/281-420

Component plug; 2-pole; with rectifier diode and LED; 10 mm wide; gray



Item No.: 280-803/281-421

Component plug; 2-pole; with rectifier diode and LED; 10 mm wide; gray

1.2.8.2 Component module with LED



Item No.: 280-803/281-415

Component plug; 2-pole; LED (red); 10 mm wide; gray



Item No.: 280-803/281-416

Component plug; 2-pole; LED (red); 10 mm wide; gray



Item No.: 280-803/281-413

Component plug; 2-pole; LED (red); 24 VDC; 10 mm wide; gray



Item No.: 280-803/281-414

Component plug; 2-pole; LED (red); 48 VDC; 10 mm wide; gray



Item No.: 280-803/281-420

Component plug; 2-pole; with rectifier diode and LED; 10 mm wide; gray



Item No.: 280-803/281-421

Component plug; 2-pole; with rectifier diode and LED; 10 mm wide; gray

1.2.8.3 Empty component plug housing



Item No.: 280-803

Empty component plug housing; 10 mm wide; Type 4; 2-pole; gray

1.2.8.4 Neon indicator module



Item No.: 280-803/281-417

Component plug; 2-pole; 10 mm wide; gray

Item No.: 280-803/281-418

Component plug; 2-pole; 10 mm wide; gray

1.2.9 Protective warning marker

1.2.9.1 Cover



Item No.: 280-415

Protective warning marker; for 5 terminal blocks; with high-voltage symbol, black; yellow

1.2.10 Push-in type wire jumper

1.2.10.1 Jumper



Item No.: 249-126

Push-in type wire jumper; 0.75 mm²; insulated; 110 mm long; black

Item No.: 249-123

Push-in type wire jumper; 0.75 mm²; insulated; 180 mm long; black

Item No.: 249-127

Push-in type wire jumper; 0.75 mm²; insulated; 250 mm long; black

Item No.: 249-125

Push-in type wire jumper; insulated; 60 mm long; black

1.2.11 Test and measurement

1.2.11.1 Testing accessories



Item No.: 249-107

B-type spacer module; modular; e.g., for bridging commoned terminal blocks; gray

Item No.: 249-106

B-type test plug module; modular; 1,50 mm²; gray

Item No.: 249-147

B-type test plug module; modular; 2,50 mm²; gray

Item No.: 249-142

L-type end module; modular; with rigid contact pin; End module; 1,50 mm²; gray



Item No.: 249-143

L-type spacer module; modular; e.g., bridging commoned terminal blocks; gray

Item No.: 249-141

L-type test plug module; modular; with spring-loaded contact pin; Center module; 1,50 mm²; gray

Item No.: 280-419

Spacer module; modular; bridging commoned terminal blocks; gray

Item No.: 280-404

Test plug adapter; 5 mm wide; for test plug (2.3 mm Ø); suitable for 1.5 mm² - 4 mm² tbs; gray



Item No.: 209-170

Test plug adapter; 8.3 mm wide; for 4 mm Ø test plugs; suitable for 1.5 mm² - 10 mm² tbs; gray

Item No.: 280-418

Test plug module; modular; suitable for all WAGO 280 and 780 Series rail-mounted terminal blocks with jumper slots in the current bar; gray

Item No.: 281-407

Test plug; 6 mm wide; Nominal current 24 A; for 0.08 mm² - 2.5 mm²; 2,50 mm²; gray

1.2.12 Tool

1.2.12.1 Operating tool



Item No.: 210-658

Operating tool; Blade: 3.5 x 0.5 mm; with a partially insulated shaft; angled; short; multicoloured



Item No.: 210-720

Operating tool; Blade: 3.5 x 0.5 mm; with a partially insulated shaft; multicoloured



Item No.: 210-657

Operating tool; Blade: 3.5 x 0.5 mm; with a partially insulated shaft; short; multicoloured

Installation Notes

Installation

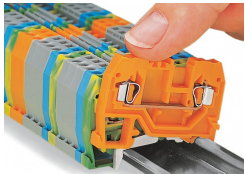

Snapping a terminal block onto the DIN-rail.

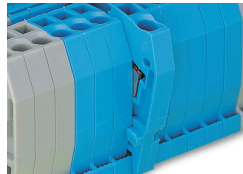

Quick assembly keys prevent reverse mounting.

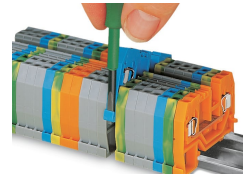

Removing a terminal block from the assembly.

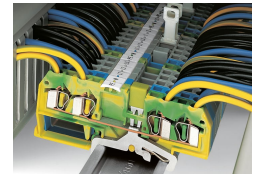

Steel DIN-rails are not suited for PEN (ground and N-conductor) applications per EN 60947-7-2 (VDE 0611, Part 3).

Conductor termination

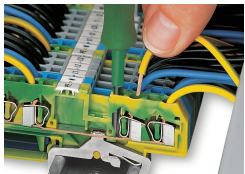

CAGE CLAMP® connection
Inserting a conductor.



CAGE CLAMP® connection
Inserting a conductor.
With ferruled conductors, it is necessary to use a terminal block one size larger than the conductor's nominal cross-section.



Inserting insulation stops.

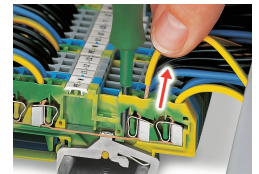

CAGE CLAMP® connection
Removing a solid conductor.

Commoning

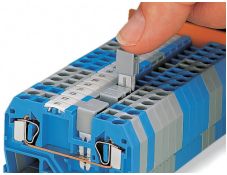

Commoning using an adjacent jumper. Push jumper down until fully inserted!

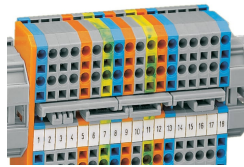

Staggered jumpers are suitable for sophisticated circuit requirements. Push jumpers down until fully inserted!

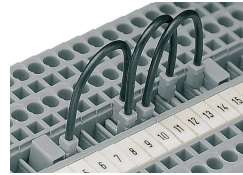

Push-In Type Wire Jumpers

When installing machines or control systems, it is often necessary to make an additional connection between two terminal blocks that are not next to each other on the rail. In such cases, WAGO's touch-proof, push-in type wire jumpers are the ideal solution.

These jumpers are compatible with the following rail-mount terminal blocks:
 - 279 Series (1.5 mm²/16 AWG),
 - 280/775/780 Series (2.5 mm²/14 AWG)
 - 281/769/776/777/781 and 880 Series (4 mm²/12 AWG)
 They are available in three conductor lengths (60, 110 and 250 mm), allowing up to 60 terminal blocks to be commoned depending on their width (see table on the right).

The 280/775/780 and 281/776/777/781 Series Terminal Blocks accept two wire jumpers, allowing the use of commoning chains. Furthermore, the 280/769/775/780/880 and 281/776/777/781 Series allow both wire jumper and adjacent jumper to be simultaneously plugged into a same terminal block.

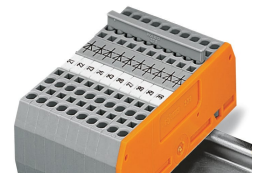

Commoning using comb-style jumper bars: Push comb-style jumper bars down until fully inserted.

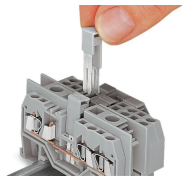

Commoning terminal blocks of different sizes via step-down jumpers.

Testing

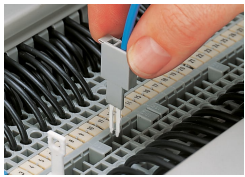

Testing with a test plug. Picture shows a test plug fitted with CAGE CLAMP®.

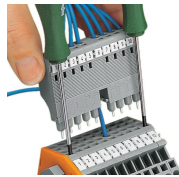

L-type test plug modules fitted with CAGE CLAMP®

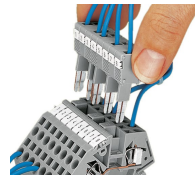

B-type test plug modules fitted with CAGE CLAMP®

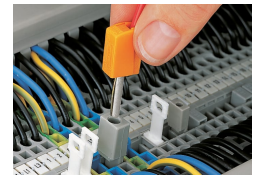

Testing with a test plug. Picture shows a test plug adapter (209-170).

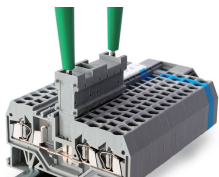

Test plug modules are directly plugged into the jumper contact slot of the current bar.

Cover

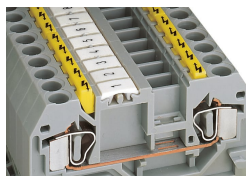

Protective warning markers inserted into the operating slots

Marking

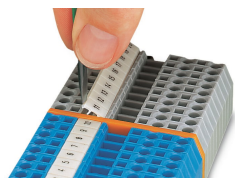

Labeling via WMB Multi Marking System.

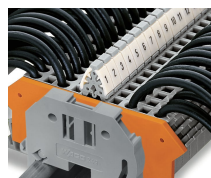

Terminal block marking with double marker carriers (209-128) Terminal blocks with side marking