

## Data Sheet | Item Number: 280-519

Double-deck terminal block; Through/through terminal block; for DIN-rail 35 x 15 and 35 x 7.5; 2.5 mm<sup>2</sup>; CAGE CLAMP®; 2,50 mm<sup>2</sup>; gray/gray

<https://www.wago.com/280-519>

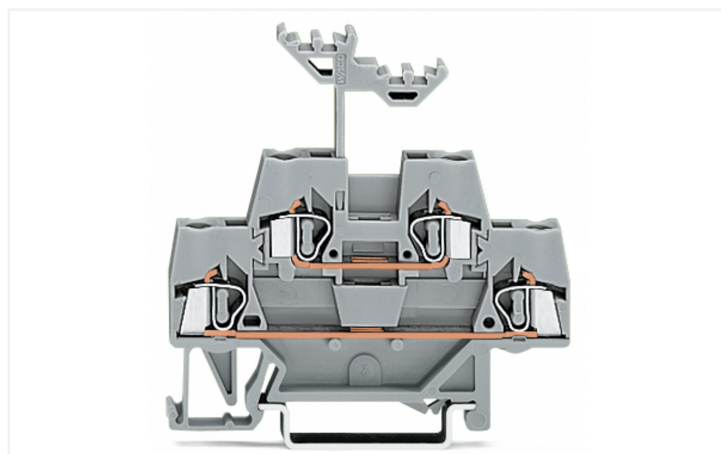
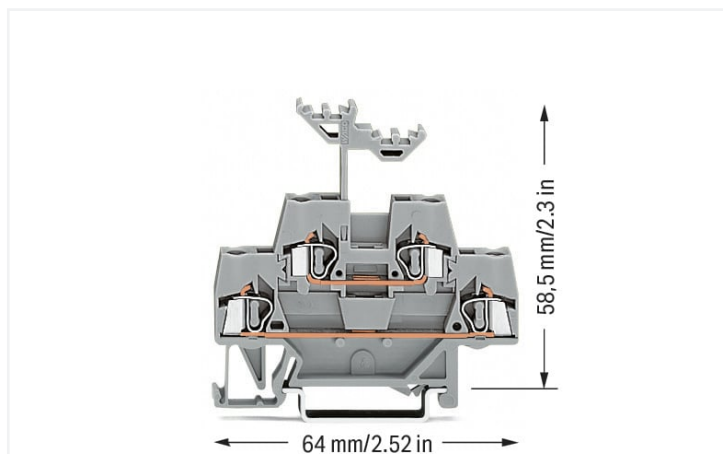

Color: ■ gray/gray

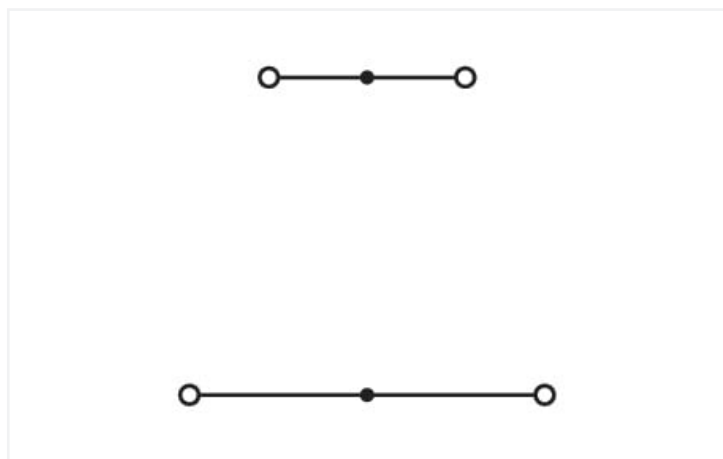

Similar to illustration

### Electrical data

Ratings per	IEC/EN 60947-7-1		
Overvoltage category	III	III	II
Pollution degree	3	2	2
Nominal voltage	500 V	-	-
Rated surge voltage	6 kV	-	-
Rated current	20 A	-	-

### Power Loss

Power loss, per pole (potential)	0.532 W
Rated current $I_N$ for specified power loss	20 A
Resistance value for specified, current-dependent power loss	0.00133 $\Omega$

### Connection data

Clamping units	4
Total number of potentials	2
Number of levels	2

### Connection 1

Connection technology	CAGE CLAMP®
Actuation type	Operating tool
Connectable conductor materials	Copper Aluminum

## Connection 1

Connectable conductor materials (note)

### Terminating Aluminum Conductors

WAGO spring clamp terminal blocks are suitable for solid aluminum conductors up to 4 mm<sup>2</sup>/12 AWG if WAGO "Alu-Plus" Contact Paste [249-130](#) is used for termination.

"Alu-Plus" Contact Paste Advantages:

- Automatically destroys the oxide film during clamping.
- Prevents fresh oxidation at the clamping point.
- Prevents electrolytic corrosion between aluminum and copper conductors (in the same terminal block).
- Provides long-term protection against corrosion.

Using terminal blocks with CAGE CLAMP® Spring Pressure Connection Technology, **aluminum conductors must first be cleaned with a blade** and then immediately be inserted into the clamping units filled with "Alu-Plus" Contact Paste.

It is also possible to apply WAGO "Alu-Plus" **additionally** on the whole surface of the aluminum conductor before termination.

Please note that the nominal currents must be adapted to the reduced conductivity of the aluminum conductors::

2.5 mm<sup>2</sup> = 16 A

4 mm<sup>2</sup> = 22 A

Solid conductor	0.08 ... 2.5 mm <sup>2</sup> / 28 ... 12 AWG
Fine-stranded conductor	0.08 ... 2.5 mm <sup>2</sup> / 28 ... 12 AWG
Note (conductor cross-section)	12 AWG: THHN, THWN
Strip length	8 ... 9 mm / 0.31 ... 0.35 inches
Wiring direction	Front-entry wiring

## Physical data

Width	5 mm / 0.197 inches
Height	64 mm / 2.52 inches
Depth from upper-edge of DIN-rail	58.5 mm / 2.303 inches

## Mechanical data

Design	horizontal type
Mounting type	DIN-35 rail
Marking level	Center marking

## Material data

Note (material data)	<a href="#">Information on material specifications can be found here</a>
Color	gray/gray
Material group	I
Insulation material (main housing)	Polyamide (PA66)
Flammability class per UL94	V0
Fire load	0.19 MJ
Weight	10.1 g

### Environmental requirements

Processing temperature	-35 ... +85 °C
Continuous operating temperature	-60 ... +105 °C

### Commercial data

Product Group	1 (Rail Mounted Terminal Blocks)
eCl@ss 10.0	27-14-11-20
eCl@ss 9.0	27-14-11-20
ETIM 9.0	EC000897
ETIM 8.0	EC000897
PU (SPU)	50 pcs
Packaging type	Box
Country of origin	CN
GTIN	4050821293583
Customs tariff number	85369010000

### Environmental Product Compliance

RoHS Compliance Status	Compliant, No Exemption
------------------------	-------------------------

### Approvals / Certificates

#### General approvals



Approval	Standard	Certificate Name
CCA DEKRA Certification B.V.	EN 60947	2157201.01
CSA DEKRA Certification B.V.	C22.2	1536071
UR Underwriters Laboratories Inc.	UL 1059	E45172

#### Declarations of conformity and manufacturer's declarations

Approval	Standard	Certificate Name
EU-Declaration of Conformity WAGO GmbH & Co. KG	-	-
UK-Declaration of Conformity WAGO GmbH & Co. KG	-	-

### Approvals for marine applications



Approval	Standard	Certificate Name
ABS American Bureau of Shipping	EN 60947	20-HG1941090-PDA
BV Bureau Veritas S.A.	EN 60947	07436/F0 BV
DNV GL Det Norske Veritas, Germanischer Lloyd	-	TAE00001V2
LR Lloyds Register	EN 60947	91/20112 (E9)

**Downloads**

**Environmental Product Compliance**

Compliance Search	
Environmental Product Compliance 280-519	<a href="#">↓</a>

**Documentation**

Additional Information		
Technical Section	pdf 2246.92 KB	<a href="#">↓</a>

Bid Text			
280-519	19.02.2019	xml 3.35 KB	<a href="#">↓</a>
280-519	28.02.2017	doc 24.50 KB	<a href="#">↓</a>

**CAD/CAE-Data**

CAD data	
2D/3D Models 280-519	<a href="#">↓</a>

CAE data	
EPLAN Data Portal 280-519	<a href="#">↓</a>
WSCAD Universe 280-519	<a href="#">↓</a>
ZUKEN Portal 280-519	<a href="#">↓</a>

**1 Compatible Products**

**1.1 Required Accessories**

**1.1.1 End plate**

**1.1.1.1 End plate**



**Item No.: 280-340**  
End and intermediate plate; 2.5 mm thick; gray



**Item No.: 280-341**  
End and intermediate plate; 2.5 mm thick; orange



**Item No.: 280-366**  
Intermediate plate; 1.1 mm thick; orange

**1.2 Optional Accessories**

**1.2.1 DIN-rail**

**1.2.1.1 Mounting accessories**



**Item No.: 210-196**  
Aluminum carrier rail; 35 x 8.2 mm; 1.6 mm thick; 2 m long; unslotted; similar to EN 60715; silver-colored



**Item No.: 210-198**  
Copper carrier rail; 35 x 15 mm; 2.3 mm thick; 2 m long; unslotted; according to EN 60715; copper-colored



**Item No.: 210-508**  
Steel carrier rail; 35 x 15 mm; 1.5 mm thick; 2 m long; slotted; galvanized; similar to EN 60715; silver-colored



**Item No.: 210-197**  
Steel carrier rail; 35 x 15 mm; 1.5 mm thick; 2 m long; slotted; similar to EN 60715; silver-colored



**Item No.: 210-506**  
Steel carrier rail; 35 x 15 mm; 1.5 mm thick; 2 m long; unslotted; galvanized; similar to EN 60715; silver-colored



**Item No.: 210-114**  
Steel carrier rail; 35 x 15 mm; 1.5 mm thick; 2 m long; unslotted; similar to EN 60715; silver-colored



**Item No.: 210-118**  
Steel carrier rail; 35 x 15 mm; 2.3 mm thick; 2 m long; unslotted; according to EN 60715; silver-colored



**Item No.: 210-115**  
Steel carrier rail; 35 x 7.5 mm; 1 mm thick; 2 m long; slotted; according to EN 60715; "Hole width 18 mm; silver-colored

1.2.1.1 Mounting accessories



**Item No.: 210-112**  
Steel carrier rail; 35 x 7.5 mm; 1 mm thick; 2 m long; slotted; according to EN 60715; "Hole width 25 mm; silver-colored



**Item No.: 210-504**  
Steel carrier rail; 35 x 7.5 mm; 1 mm thick; 2 m long; slotted; galvanized; according to EN 60715; silver-colored



**Item No.: 210-113**  
Steel carrier rail; 35 x 7.5 mm; 1 mm thick; 2 m long; unslotted; according to EN 60715; silver-colored



**Item No.: 210-505**  
Steel carrier rail; 35 x 7.5 mm; 1 mm thick; 2 m long; unslotted; galvanized; according to EN 60715; silver-colored

1.2.2 Ferrule

1.2.2.1 Ferrule



**Item No.: 216-301**  
Ferrule; Sleeve for 0.25 mm<sup>2</sup> / AWG 24; insulated; electro-tin plated; yellow



**Item No.: 216-302**  
Ferrule; Sleeve for 0.34 mm<sup>2</sup> / 22 AWG; insulated; electro-tin plated; light turquoise



**Item No.: 216-201**  
Ferrule; Sleeve for 0.5 mm<sup>2</sup> / 20 AWG; insulated; electro-tin plated; white



**Item No.: 216-101**  
Ferrule; Sleeve for 0.5 mm<sup>2</sup> / AWG 22; un-insulated; electro-tin plated; silver-colored



**Item No.: 216-202**  
Ferrule; Sleeve for 0.75 mm<sup>2</sup> / 18 AWG; insulated; electro-tin plated; gray



**Item No.: 216-102**  
Ferrule; Sleeve for 0.75 mm<sup>2</sup> / AWG 20; un-insulated; electro-tin plated; silver-colored



**Item No.: 216-203**  
Ferrule; Sleeve for 1 mm<sup>2</sup> / AWG 18; insulated; electro-tin plated; red



**Item No.: 216-103**  
Ferrule; Sleeve for 1 mm<sup>2</sup> / AWG 18; un-insulated; electro-tin plated



**Item No.: 216-204**  
Ferrule; Sleeve for 1.5 mm<sup>2</sup> / AWG 16; insulated; electro-tin plated; black



**Item No.: 216-104**  
Ferrule; Sleeve for 1.5 mm<sup>2</sup> / AWG 16; un-insulated; electro-tin plated; silver-colored

1.2.3 Installation

1.2.3.1 Cover



**Item No.: 709-154**  
Cover; Type 2; suitable for cover carrier, type 2; 1 m long; transparent

1.2.3.2 Cover carrier



**Item No.: 709-168**  
Cover carrier; Type 2; incl. fixing/retaining screws and knurled nut; suitable for 283 to 285 Series rail-mounted terminal blocks; suitable for 279 to 281 Series double- and triple-deck terminal blocks; suitable for 780 to 785, 775, 776 and 777 Series TOP-JOB® rail-mounted terminal blocks; suitable for 280 Series sensor and actuator terminal blocks; suitable for 282 Series disconnect/test terminal blocks for transformer circuits; gray

1.2.3.3 Mounting accessories



**Item No.: 209-106**  
Mounting carrier; for isolated mounting on DIN 35 rails; gray

**Item No.: 249-116**  
Screwless end stop; 6 mm wide; for DIN-rail 35 x 15 and 35 x 7.5; gray

1.2.4 Insulation stop

1.2.4.1 Insulation stop



**Item No.: 280-470**  
Insulation stop; 0.08 - 0.2 mm<sup>2</sup> "s" (0.14 mm<sup>2</sup> "f-st"); 5 pieces/strip; white

**Item No.: 280-471**  
Insulation stop; 0.25 - 0.5 mm<sup>2</sup>; 5 pieces/strip; light gray

**Item No.: 280-472**  
Insulation stop; 0.75 - 1 mm<sup>2</sup>; 5 pieces/strip; black

1.2.5 Jumper

1.2.5.1 Jumper



**Item No.: 280-490**  
Jumper; 10-way; insulated; gray

**Item No.: 280-482**  
Jumper; 2-way; insulated; gray

**Item No.: 280-492**  
Jumper; 2-way; insulated; gray

**Item No.: 280-483**  
Jumper; 3-way; insulated; gray



**Item No.: 280-484**  
Jumper; 4-way; insulated; gray

**Item No.: 280-485**  
Jumper; 5-way; insulated; gray

**Item No.: 280-402**  
Jumper; insulated; gray

**Item No.: 280-409**  
Jumper; insulated; gray



**Item No.: 780-452**  
Staggered jumper; from 1 to 2; insulated; gray

**Item No.: 780-453**  
Staggered jumper; from 1 to 3; insulated; gray

**Item No.: 780-454**  
Staggered jumper; from 1 to 4; insulated; gray

**Item No.: 780-455**  
Staggered jumper; from 1 to 5; insulated; gray



**Item No.: 780-456**  
Staggered jumper; from 1 to 6; insulated; gray

**Item No.: 780-457**  
Staggered jumper; from 1 to 7; insulated; gray

**Item No.: 780-458**  
Staggered jumper; from 1 to 8; insulated; gray

**Item No.: 281-421**  
Vertical jumper; insulated; gray



**Item No.: 709-110**  
Wire commoning chain; 2.5 mm<sup>2</sup>; insulated; black

**Item No.: 709-111**  
Wire commoning chain; 2.5 mm<sup>2</sup>; insulated; black

**Item No.: 709-112**  
Wire commoning chain; 2.5 mm<sup>2</sup>; insulated; black

**Item No.: 210-103**  
Wire commoning chain; insulated; black



**Item No.: 210-123**  
Wire commoning chain; insulated; blue

## 1.2.6 Marking

### 1.2.6.1 Marker



**Item No.: 793-5501**

WMB marking card; as card; for terminal block width 5 - 17.5 mm; stretchable 5 - 5.2 mm; plain; snap-on type; white



**Item No.: 793-501**

WMB marking card; as card; not stretchable; plain; snap-on type; white



**Item No.: 2009-115**

WMB-Inline; for Smart Printer; 1500 pieces on roll; stretchable 5 - 5.2 mm; plain; snap-on type; white

## 1.2.7 Protective warning marker

### 1.2.7.1 Cover



**Item No.: 280-415**

Protective warning marker; for 5 terminal blocks; with high-voltage symbol, black; yellow

## 1.2.8 Push-in type wire jumper

### 1.2.8.1 Jumper



**Item No.: 249-126**

Push-in type wire jumper; 0.75 mm<sup>2</sup>; insulated; 110 mm long; black



**Item No.: 249-123**

Push-in type wire jumper; 0.75 mm<sup>2</sup>; insulated; 180 mm long; black



**Item No.: 249-127**

Push-in type wire jumper; 0.75 mm<sup>2</sup>; insulated; 250 mm long; black



**Item No.: 249-125**

Push-in type wire jumper; insulated; 60 mm long; black

## 1.2.9 Test and measurement

### 1.2.9.1 Testing accessories



**Item No.: 249-142**

L-type end module; modular; with rigid contact pin; End module; 1,50 mm<sup>2</sup>; gray



**Item No.: 249-141**

L-type test plug module; modular; with spring-loaded contact pin; Center module; 1,50 mm<sup>2</sup>; gray

## 1.2.10 Tool

### 1.2.10.1 Operating tool



**Item No.: 210-658**

Operating tool; Blade: 3.5 x 0.5 mm; with a partially insulated shaft; angled; short; multicoloured



**Item No.: 210-720**

Operating tool; Blade: 3.5 x 0.5 mm; with a partially insulated shaft; multicoloured



**Item No.: 210-657**

Operating tool; Blade: 3.5 x 0.5 mm; with a partially insulated shaft; short; multicoloured

## Installation Notes

### Installation

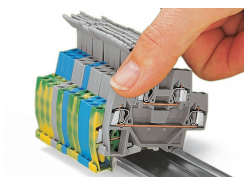

Snapping a terminal block onto the DIN-rail.

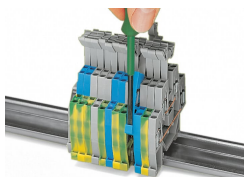

Removing a terminal block from the assembly.

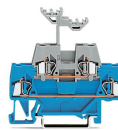

Double-deck terminal blocks accommodate two circuits of different potentials on two decks; different circuits can be differentiated by color coding either deck (280 Series). The lower deck is wider than the upper for easier wiring.

### Conductor termination

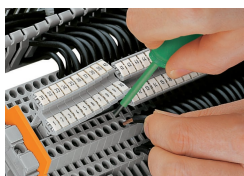
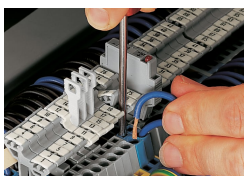

The flexible marker carrier, which is placed above the wiring level, can be pushed aside during wiring or commoning. The carrier has two staggered levels for WMB markers that perfectly align with the terminal block decks.

### Commoning

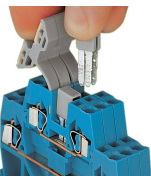

Commoning using an adjacent jumper. Push jumpers down until fully inserted!

### Commoning

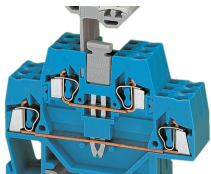

Commoning with a vertical jumper (281-421). Push vertical jumper down until fully inserted!



Combining vertical and adjacent jumpers.

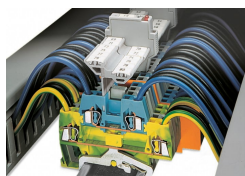

Example of a mixed assembly with double-deck terminal blocks.

The 280 Series Double-Deck Terminal Blocks are available with decks of same or different color according to their function. This is an additional visual aid during wiring, service or maintenance.

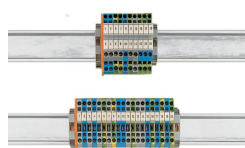
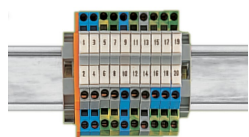

With a terminal block width of just 5 mm, an effective width of just 2.5 mm for terminal blocks of same or different potentials can be realized for conductors ranging 0.08 mm<sup>2</sup> ... 2.5 mm<sup>2</sup> (28 ... 14 AWG).

Use 50% less rail space with double-deck terminal blocks.

## Marking

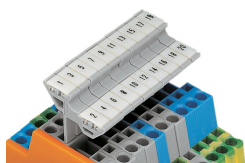

Labeling via WMB Multi Marking System.