

# Data Sheet | Item Number: 2626-1105/020-000

PCB terminal block; 6 mm<sup>2</sup>; Pin spacing 7.5 mm; 5-pole; Push-in CAGE CLAMP®; 6,00 mm<sup>2</sup>; gray

<https://www.wago.com/2626-1105/020-000>



Color: ■ gray

Similar to illustration

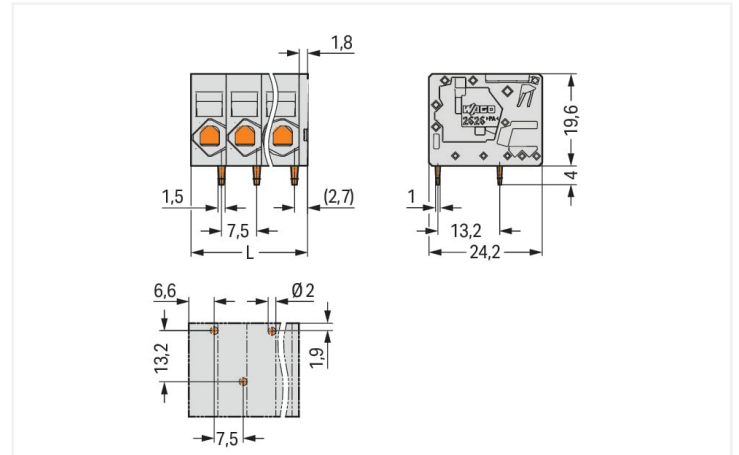

Dimensions in mm

L = (pole no. - 1) x pin spacing + 9.3 mm

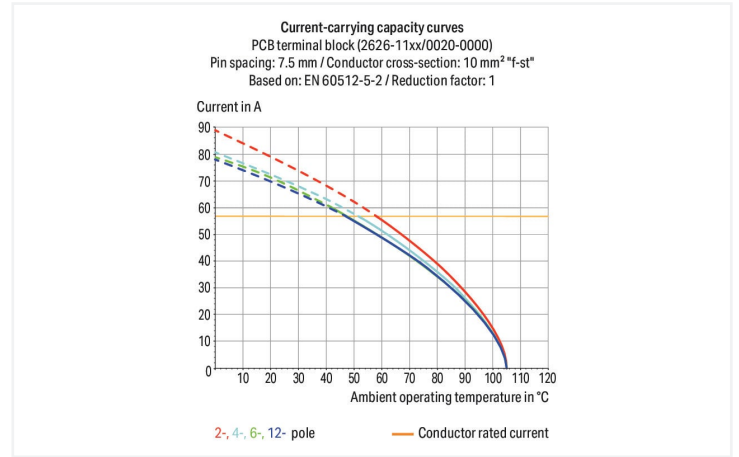
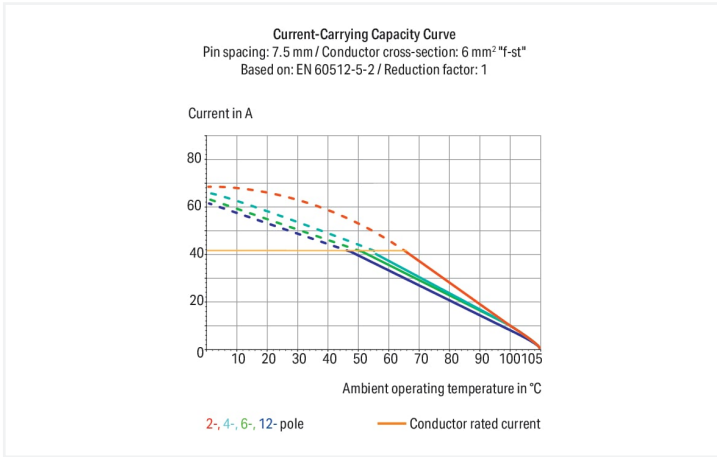

- PCB terminal strips with Push-in CAGE CLAMP® connection
- Push-in termination of solid and ferruled conductors
- Ideal for panel feedthrough applications via operation parallel to conductor entry
- Testing can be performed both parallel and perpendicular to conductor entry

## Notes

Variants:

Other versions (or variants) can be requested from WAGO Sales or configured at <https://configurator.wago.com/>.  
Other pole numbers  
Direct marking  
Other colors

## Electrical data

Ratings per	IEC/EN 60664-1		
Overvoltage category	III	III	II
Pollution degree	3	2	2
Nominal voltage	1000 V	1000 V	1000 V
Rated surge voltage	8 kV	8 kV	8 kV
Rated current	48 A	48 A	48 A

Approvals per	UL 1059		
Use group	B	C	D
Rated voltage	600 V	600 V	-
Rated current	38 A	38 A	-

Approvals per	CSA		
	B	C	D
Use group	B	C	D
Rated voltage	600 V	600 V	-
Rated current	31 A	31 A	-

### Connection data

Clamping units	5
Total number of potentials	5
Number of connection types	1
Number of levels	1

### Connection 1

Connection technology	Push-in CAGE CLAMP®
Actuation type	Operating tool
Solid conductor	0.2 ... 10 mm <sup>2</sup> / 24 ... 8 AWG
Fine-stranded conductor	0.2 ... 10 mm <sup>2</sup> / 24 ... 8 AWG
Fine-stranded conductor; with insulated ferrule	0.25 ... 6 mm <sup>2</sup>
Fine-stranded conductor; with uninsulated ferrule	0.25 ... 6 mm <sup>2</sup>
Fine-stranded conductor; with twin ferrule	0.25 ... 2.5 mm <sup>2</sup>
Strip length	13 ... 15 mm / 0.51 ... 0.59 inches
Conductor connection direction to PCB	0°
Pole number	5

### Physical data

Pin spacing	7.5 mm / 0.295 inches
Width	39.3 mm / 1.547 inches
Height	23.6 mm / 0.929 inches
Height from the surface	19.6 mm / 0.772 inches
Depth	24.2 mm / 0.953 inches
Solder pin length	4 mm
Solder pin dimensions	1.5 x 1 mm
Drilled hole diameter with tolerance	2 <sup>(+0.1)</sup> mm

### Mechanical data

Mounting type	Feed-through mounting
---------------	-----------------------

### PCB contact

PCB contact	THT
Solder pin arrangement	over the entire terminal strip (staggered)
Number of solder pins per potential	1

### Material data

Note (material data)	<a href="#">Information on material specifications can be found here</a>
Color	gray
Material group	I
Insulation material (main housing)	Polyamide (PA66)
Flammability class per UL94	V0
Clamping spring material	Chrome-nickel spring steel (CrNi)
Contact material	Electrolytic copper (E <sub>Cu</sub> )
Contact Plating	Tin
Fire load	0 MJ
Weight	19.6 g

### Environmental requirements

Limit temperature range	-60 ... +105 °C
Processing temperature	-35 ... +60 °C
Continuous operating temperature	-60 ... +105 °C

### Commercial data

eCl@ss 10.0	27-44-04-01
eCl@ss 9.0	27-44-04-01
ETIM 9.0	EC002643
ETIM 8.0	EC002643
PU (SPU)	60 pcs
Packaging type	Box
Country of origin	DE
GTIN	4055143587129
Customs tariff number	85369010000

### Environmental Product Compliance

RoHS Compliance Status	Compliant, No Exemption
------------------------	-------------------------

### Approvals / Certificates

#### General approvals



Approval	Standard	Certificate Name
CB DEKRA Certification B.V.	IEC 60947-7-4	NL-103311
CSA CSA Group	C22.2	70146882
KEMA/KEUR DEKRA Certification B.V.	EN 60947-7-4	71-113203
UL Underwriters Laboratories Inc.	UL 1059	E45172

### Downloads

#### Environmental Product Compliance

##### Compliance Search

Environmental Product  
Compliance  
2626-1105/020-000





## Documentation



### Additional Information

Technical Section	03.04.2019	pdf 2027.26 KB	
-------------------	------------	-------------------	---

## CAD/CAE-Data

CAD data	CAE data
2D/3D Models 2626-1105/020-000 	ZUKEN Portal 2626-1105/020-000 

## PCB Design

Symbol and Footprint via SamacSys 2626-1105/020-000 
Symbol and Footprint via Ultra Librarian 2626-1105/020-000 

## 1 Compatible Products

### 1.1 Optional Accessories

#### 1.1.1 Tool

##### 1.1.1.1 Operating tool



#### Item No.: 210-721

Operating tool; Blade: 5.5 x 0.8 mm; with a partially insulated shaft; multicoloured

## Installation Notes

### Conductor termination



Insert fine-stranded conductors and remove all conductor types via operating tool.

## Conductor termination



Insert solid conductors via push-in termination.